

SAMSUNG

FULL MANUAL

HW-Q600C

Imagine the possibilities

Thank you for purchasing this Samsung product.

To receive more complete service, please register
your product at www.samsung.com/register

SAFETY INFORMATION









SAFETY WARNINGS

TO REDUCE THE RISK OF ELECTRIC SHOCK, DO NOT REMOVE THE COVER (OR BACK).

NO USER-SERVICEABLE PARTS ARE INSIDE.

REFER SERVICING TO QUALIFIED SERVICE PERSONNEL.

Refer to the table below for an explanation of symbols which may be on your Samsung product.

	<p style="text-align: center;">CAUTION RISK OF ELECTRIC SHOCK. DO NOT OPEN.</p>	
	<p>This symbol indicates that high voltage is present inside. It is dangerous to make any kind of contact with any internal part of this product.</p>	
	<p>This symbol indicates that this product has included important literature concerning operation and maintenance.</p>	
	<p>Class II product : This symbol indicates that it does not require a safety connection to electrical earth (ground). If this symbol is not present on a product with a power cord, the product MUST have a reliable connection to protective earth (ground).</p>	
	<p>AC voltage : This symbol indicates that the rated voltage marked with the symbol is AC voltage.</p>	
	<p>DC voltage : This symbol indicates that the rated voltage marked with the symbol is DC voltage.</p>	
	<p>Caution, Consult instructions for use : This symbol instructs the user to consult the user manual for further safety related information.</p>	

WARNING

- To reduce the risk of fire or electric shock, do not expose this appliance to rain or moisture.

CAUTION

- TO PREVENT ELECTRIC SHOCK, MATCH WIDE BLADE OF PLUG TO WIDE SLOT, FULLY INSERT.
- This apparatus shall always be connected to a AC outlet with a protective grounding connection.
- To disconnect the apparatus from the mains, the plug must be pulled out from the mains socket, therefore the mains plug shall be readily operable.
- Do not expose this apparatus to dripping or splashing. Do not put objects filled with liquids, such as vases on the apparatus.
- To turn this apparatus off completely, you must pull the power plug out of the wall socket. Consequently, the power plug must be easily and readily accessible at all times.

Wiring the Main Power Supply Plug (UK Only)

IMPORTANT NOTICE

The mains lead on this equipment is supplied with a moulded plug incorporating a fuse. The value of the fuse is indicated on the pin face of the plug and if it requires replacing, a fuse approved to BS1362 of the same rating must be used. Never use the plug with the fuse cover removed. If the cover is detachable and a replacement is required, it must be of the same colour as the fuse fitted in the plug. Replacement covers are available from your dealer. If the fitted plug is not suitable for the power points in your house or the cable is not long enough to reach a power point, you should obtain a suitable safety approved extension lead or consult your dealer for assistance.

However, if there is no alternative to cutting off the plug, remove the fuse and then safely dispose of the plug. Do not connect the plug to a mains socket as there is a risk of shock hazard from the bared flexible cord. Never attempt to insert bare wires directly into a mains socket. A plug and fuse must be used at all times.

IMPORTANT

The wires in the mains lead are coloured in accordance with the following code:– BLUE = NEUTRAL BROWN = LIVE As these colours may not correspond to the coloured markings identifying the terminals in your plug, proceed as follows:– The wire coloured BLUE must be connected to the terminal marked with the letter N or coloured BLUE or BLACK. The wire coloured BROWN must be connected to the terminal marked with the letter L or coloured BROWN or RED.

WARNING : DO NOT CONNECT EITHER WIRE TO THE EARTH TERMINAL WHICH IS MARKED WITH THE LETTER E OR BY THE EARTH SYMBOL , OR COLOURED GREEN OR GREEN AND YELLOW.

PRECAUTIONS

1. Ensure that the AC power supply in your house complies with the power requirements listed on the identification sticker located on the bottom of your product. Install your product horizontally, on a suitable base (furniture), with enough space around it for ventilation (7~10 cm). Make sure the ventilation slots are not covered. Do not place the unit on amplifiers or other equipment which may become hot. This unit is designed for continuous use. To fully turn off the unit, disconnect the AC plug from the wall outlet. Unplug the unit if you intend to leave it unused for a long period of time.

2. During thunderstorms, disconnect the AC plug from the wall outlet. Voltage peaks due to lightning could damage the unit.
 3. Do not expose the unit to direct sunlight or other heat sources. This could lead to overheating and cause the unit to malfunction.
 4. Protect the product from moisture (i.e. vases), and excess heat (e.g. a fireplace) or equipment creating strong magnetic or electric fields. Unplug the power cable from the AC wall socket if the unit malfunctions. Your product is not intended for industrial use. It is for personal use only. Condensation may occur if your product has been stored in cold temperatures. If transporting the unit during the winter, wait approximately 2 hours or until the unit has reached room temperature before using.
 5. The battery used with this product contains chemicals that are harmful to the environment. Do not dispose of the battery in the general household trash. Do not expose the battery to excess heat, direct sunlight, or fire. Do not short circuit, disassemble, or overheat the battery.
- CAUTION :** Danger of explosion if the battery is replaced incorrectly. Replace only with the same or equivalent type.

CONTENTS

01	Checking the Components	6
02	Product Overview	7
	Front Panel / Top Panel of the Soundbar	7
	Bottom Panel of the Soundbar	8
03	Using the Remote Control	9
	Inserting Batteries before using the Remote Control (AAA batteries X 2)	9
	How to Use the Remote Control	9
	Using the Hidden Buttons (Buttons with more than one function)	13
	Output specifications for the different sound effect modes	13
	Adjusting the Soundbar volume with a TV remote control	14
04	Connecting the Soundbar	15
	Connecting Electrical Power	15
	Connecting the Samsung Wireless Rear Kit to your Soundbar	18
05	Connecting to a TV	19
	Method 1. Connecting with HDMI	19
	Method 2. Connecting using an Optical Cable	21
	Method 3. Connecting via Bluetooth	23
06	Connecting an External Device	25
	Method 1. Connecting using an HDMI Cable (Capable of Dolby Atmos®/DTS:X decoding and playback)	25
	Method 2. Connecting using an Optical Cable	26

07	Connecting a USB drive	27
08	Connecting a Mobile Device	28
	Connecting via Bluetooth	28
	Using Tap Sound	32
09	Installing the Wall Mount	33
	Installation Precautions	33
	Wallmount Components	33
10	Installing the Soundbar in front of TV	35
11	Software Update	36
	USB Update	36
	Reset	37
12	Troubleshooting	38
13	Licence	40
14	Open Source Licence Notice	41
15	Important Notes About Service	41
16	Specifications and Guide	42
	Specifications	42

01 CHECKING THE COMPONENTS

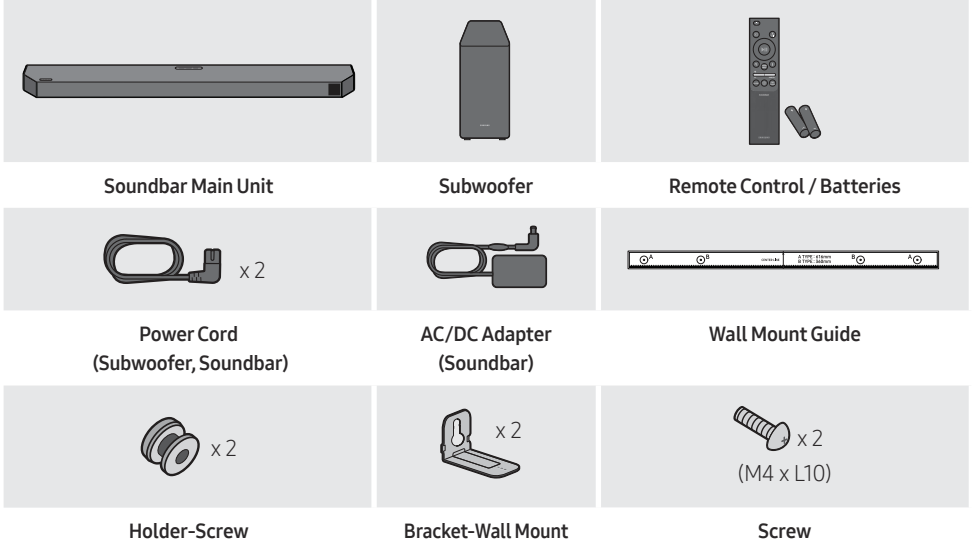

- For more information about the power supply and power consumption, refer to the label attached to the product. (Label: Bottom of the Soundbar Main Unit)
- To purchase additional components or optional cables, contact a Samsung Service Centre or Samsung Customer Care.
- For more information about the wallmount see page 33.
- Design and specifications are subject to change without prior notice.
- The appearance of the components may differ slightly from the illustrations above.

02 PRODUCT OVERVIEW

Front Panel / Top Panel of the Soundbar

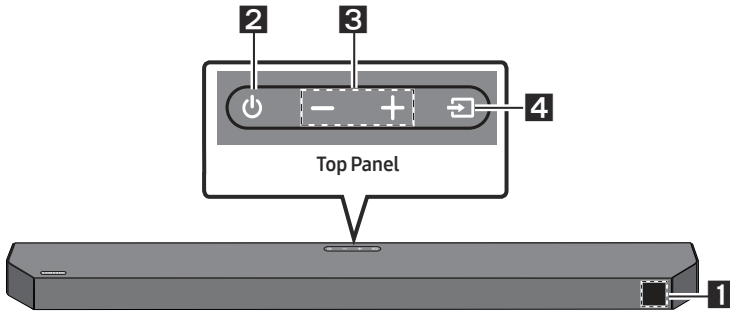

1	<p>Display Displays the product's status and current mode.</p>													
2	<p>⏻ (Power) Button Turns the power on and off.</p> <ul style="list-style-type: none"> • Auto Power Down Function The unit turns off automatically in the following situations: <ul style="list-style-type: none"> - In D.IN / HDMI / BT / USB Mode : If there is no audio signal for 18 minutes. 													
3	<p>— + (Volume) Button Adjusts the volume.</p> <ul style="list-style-type: none"> • When adjusted, the volume level appears on the Soundbar's front display. 													
4	<p>↔ (Source) Button Selects the source input mode.</p> <table border="1" data-bbox="151 1013 862 1268"> <thead> <tr> <th>Input mode</th> <th>Display</th> </tr> </thead> <tbody> <tr> <td>Optical</td> <td>D.IN</td> </tr> <tr> <td rowspan="2">eARC/ARC (HDMI OUT)</td> <td>* D.IN → TV eARC (Auto conversion)</td> </tr> <tr> <td>D.IN → TV ARC (Auto conversion)</td> </tr> <tr> <td>HDMI</td> <td>HDMI</td> </tr> <tr> <td>BLUETOOTH mode</td> <td>BT</td> </tr> <tr> <td>USB mode</td> <td>USB</td> </tr> </tbody> </table> <ul style="list-style-type: none"> • To turn on "BT PAIRING" mode, change the source to "BT" mode, and then press and hold the ↔ (Source) button for more than 5 seconds. 	Input mode	Display	Optical	D.IN	eARC/ARC (HDMI OUT)	* D.IN → TV eARC (Auto conversion)	D.IN → TV ARC (Auto conversion)	HDMI	HDMI	BLUETOOTH mode	BT	USB mode	USB
Input mode	Display													
Optical	D.IN													
eARC/ARC (HDMI OUT)	* D.IN → TV eARC (Auto conversion)													
	D.IN → TV ARC (Auto conversion)													
HDMI	HDMI													
BLUETOOTH mode	BT													
USB mode	USB													

- **"*"** mode is supported when the eARC function in the TV setting is On.
- When you plug in the AC cord, the power button will begin working in 4 to 6 seconds.

- When you turn on this unit, there will be a 4 to 5 second delay before it produces sound.
- If you hear sounds from both the TV and Soundbar, go to the **Settings** menu for the TV audio and change the TV speaker to **External Speaker**.

Bottom Panel of the Soundbar

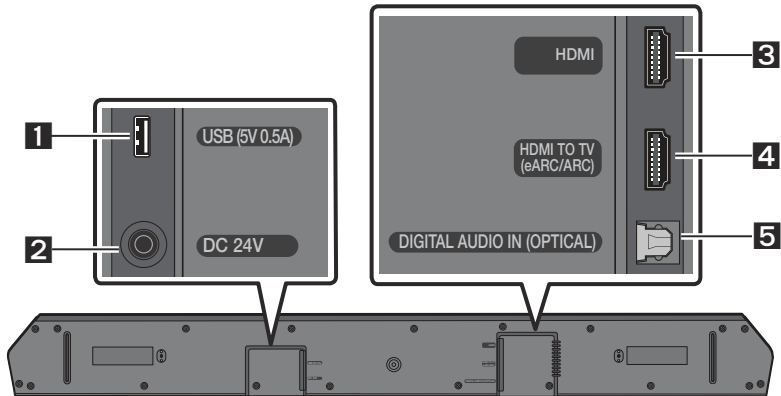

1	USB (5V 0.5A) Connect a USB drive here to play music files stored on the USB drive through the Soundbar. (See page 27)
2	DC 24V (Power Supply In) Connect the AC/DC power adapter. (See page 15)
3	HDMI Inputs digital video and audio signals simultaneously using an HDMI cable. Connect to the HDMI output of an external device. (See page 25)
4	HDMI TO TV (eARC/ARC) Connect to the HDMI IN (eARC) port on a TV. (See page 19)
5	DIGITAL AUDIO IN (OPTICAL) Connect to the digital (optical) output of an external device. (See page 26)

- When disconnecting the power cable of the AC/DC power adapter from a wall outlet, pull the plug. Do not pull the cable.
- Do not connect this unit or other components to an AC outlet until all connections between components are complete.

03 USING THE REMOTE CONTROL

Inserting Batteries before using the Remote Control (AAA batteries X 2)



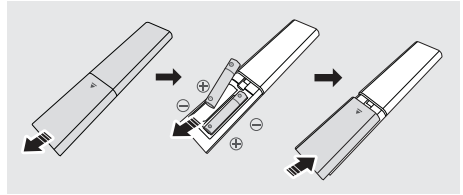

Slide the back cover in the direction of the arrow until it is completely removed.



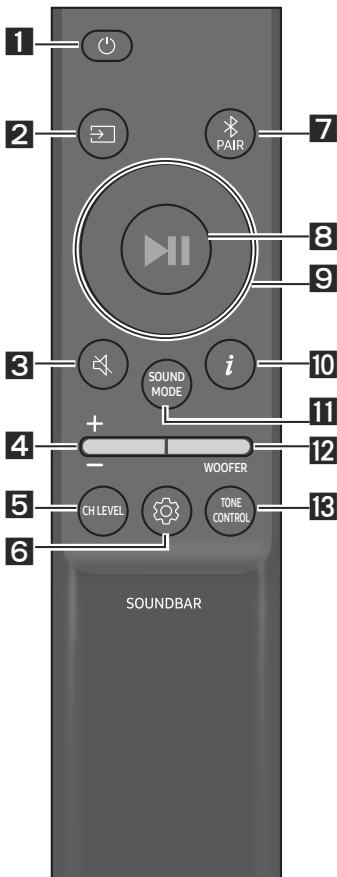

Insert 2 AAA batteries (1.5V) so that their orientation is correct. Slide the back cover back into position.



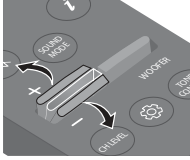
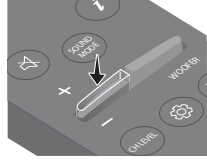





How to Use the Remote Control



<p>1</p>  <p>Power</p>	<p>Turns the Soundbar on and off.</p>
<p>2</p>  <p>Source</p>	<p>Press to select a source connected to the Soundbar.</p>
<p>3</p>  <p>Mute</p>	<p>Press the Mute button to mute the sound. Press it again to unmute the sound.</p>
<p>4</p>  <p>Volume</p>	<div style="display: flex; justify-content: space-around;">   </div> <p>Push the button up or down to adjust the volume.</p> <ul style="list-style-type: none"> • Mute Press the Volume button in to mute the sound. Press it in again to unmute the sound.

<p>5</p>	 <p>CH LEVEL</p>	<p>By pressing the button, you can adjust the volume of the each speaker.</p> <ul style="list-style-type: none"> • Press the button to select CENTER LEVEL or TOP LEVEL and then adjust the volume between -6~+6 by using the Up/Down buttons. • If the Rear Speakers (sold separately) are connected, the setting REAR LEVEL is supported. To adjust the volume of the REAR LEVEL between -6 to +6 by using the Up/Down buttons.
<p>6</p>	 <p>Sound Control</p>	<p>By pressing the button, you can set the audio function. The desired settings can be adjusted using the Up/Down buttons.</p> <p>VOICE ENHANCE ON/OFF → NIGHT MODE ON/OFF → SYNC → VIRTUAL ON/OFF</p> <ul style="list-style-type: none"> - VOICE ENHANCE ON/OFF This mode is makes it easier to hear spoken dialog in movies and TV. - NIGHT MODE ON/OFF This mode is optimized for nighttime viewing with the settings adjusted to bring the volume down but keep the dialog clear. - SYNC If the video on the TV and audio from the Soundbar are not synchronized, press the  (Sound Control) button to select SYNC and then set the audio delay between 0~300 milliseconds by using the Up/Down buttons. (Not available in “USB” or “BT” mode.) - VIRTUAL ON/OFF Dolby Virtual function can be turned ON/OFF. • The VOICE ENHANCE, NIGHT MODE, and VIRTUAL audio function can be turned ON/OFF by using the Up/Down buttons. (VIRTUAL function is not available in “USB” or “BT” mode.) • Press and hold the  (Sound Control) button for about 5 seconds to adjust the sound for each frequency band. 150Hz, 300Hz, 600Hz, 1.2kHz, 2.5kHz, 5kHz, and 10kHz are selectable using the Left/Right buttons and each can be adjusted to a setting between -6 to +6 using the Up/Down buttons. (Make sure the Sound mode is set to “STANDARD”).
<p>7</p>	 <p>Bluetooth PAIR</p>	<p>Switch the Soundbar to Bluetooth pairing mode. Press the  PAIR button and wait for the “BT PAIRING” screen to connect to a new Bluetooth device.</p>
<p>8</p>	 <p>Play / Pause</p>	<p>You can also play or pause music by pressing the button.</p>

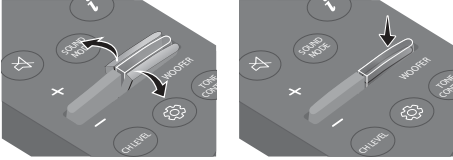
<p>9</p>  <p>Up/Down/ Left/Right</p>	 <p>Press the indicated areas to select Up/Down/Left/Right.</p> <p>Press Up/Down/Left/Right on the button to select or set functions.</p> <ul style="list-style-type: none"> • Repeat To use the Repeat function in "USB" mode, press the Up button. • Music Skip Press the Right button to select the next music file. Press the Left button to select the previous music file. • ID SET Press and hold the Up button for 5 seconds to complete ID SET (when connecting to a wireless subwoofer or wireless rear speakers).
<p>10</p>  <p>Info</p>	<p>Press to display information about the active function or the codec available.</p>
<p>11</p>  <p>SOUND MODE</p>	<p>By pressing the button, you can select the desired sound mode.</p> <p>SURROUND SOUND → GAME PRO → ADAPTIVE SOUND → STANDARD</p> <ul style="list-style-type: none"> – SURROUND SOUND Provides a wider sound field than standard. – GAME PRO Provides stereoscopic sound to immerse you in the action while gaming. – ADAPTIVE SOUND Analyzes the content in real time and automatically provides an optimal sound field based on the characteristics of the content. – STANDARD Outputs the original sound. • DRC (Dynamic Range Control) Lets you apply dynamic range control to Dolby Digital tracks. Press and hold the SOUND MODE button for more than 5 seconds while the Soundbar is powered off to turn DRC (Dynamic Range Control) on or off. With the DRC turned on, loud sound is reduced. (The sound may be distorted.) • Bluetooth Power This feature automatically turns the Soundbar on when it receives a connection request from a previously connected TV or Bluetooth device. The setting is On by default. <ul style="list-style-type: none"> – Press and hold the SOUND MODE button for more than 5 seconds to turn off the Bluetooth Power function.

<p>12</p>	 <p>WOOFER WOOFER (BASS) LEVEL</p>	 <p>Push the button up or down to adjust the level of the woofer (bass) to -12 or between -6 to +6. To set the woofer (bass) volume level to 0 (Default), press the button.</p>
<p>13</p>	 <p>TONE CONTROL</p>	<p>By pressing the button, you can adjust the volume of the treble or bass sound.</p> <ul style="list-style-type: none"> • Press the button to select TREBLE or BASS and then adjust the volume between -6~+6 by using the Up/Down buttons. Once the bass level is changed, the woofer level will be also adjusted accordingly.

Using the Hidden Buttons (Buttons with more than one function)

Hidden Button		Reference page
Remote Control Button	Function	
WOOFER (Up)	TV remote control On/Off (Standby)	page 14
Left	TV Auto connect On/Off (BT Ready)	page 24
Up	ID SET	page 11
 (Sound Control)	7 Band EQ	page 10
SOUND MODE	DRC ON/OFF (Standby)	page 11
	Bluetooth Power	page 11

Output specifications for the different sound effect modes

Effect		Input	Output	
			With Subwoofer Only	With Subwoofer & Wireless Rear Speaker Kit
 SOUND MODE	SURROUND SOUND	2.0 ch	3.1.2 ch	5.1.2 ch
		5.1 ch	3.1.2 ch	5.1.2 ch
		Dolby Atmos®, DTS:X	3.1.2 ch	5.1.2 ch
	GAME PRO	2.0 ch	3.1.2 ch	5.1.2 ch
		5.1 ch	3.1.2 ch	5.1.2 ch
		Dolby Atmos®, DTS:X	3.1.2 ch	5.1.2 ch
	ADAPTIVE SOUND	2.0 ch	3.1.2 ch	5.1.2 ch
		5.1 ch	3.1.2 ch	5.1.2 ch
		Dolby Atmos®, DTS:X	3.1.2 ch	5.1.2 ch
	STANDARD	2.0 ch	2.1 ch	2.1 ch
		5.1 ch	3.1 ch	5.1 ch
		Dolby Atmos®, DTS:X	3.1.2 ch	5.1.2 ch







- The Samsung Wireless Rear Speaker Kit can be purchased separately. To purchase a Kit, contact the vendor you purchased the Soundbar from.
- When the input source is Dolby Atmos®, DTS:X, the Subwoofer-only setup provides 3.1.2 channel audio, while the Subwoofer & Wireless Rear Speaker Kit setup provides 5.1.2 channel audio.
- The Rear Speakers will not produce sounds for 2 channel output while **STANDARD** mode is in use. To enable sound for the Rear Speakers, change the effect mode to **SURROUND SOUND**.

Adjusting the Soundbar volume with a TV remote control

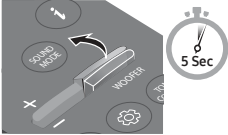
Adjust the Soundbar volume using the TV's remote control.

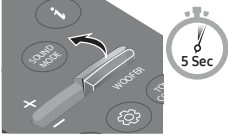
- This function can be used with IR remote controls only. Bluetooth remote controls (remote controls that require pairing) are not supported.
- Set the TV speaker to **External Speaker** to use this function.
- Manufacturers supporting this function:
Samsung, VIZIO, LG, Sony, Sharp, PHILIPS, PANASONIC, TOSHIBA, Hisense, RCA

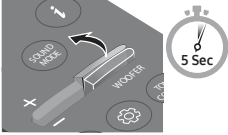
1. Turn Off the Soundbar.
2. Push up and hold the **WOOFER** button for 5 seconds.
Each time you push the **WOOFER** button up and hold it for 5 seconds, the mode switches in the following order: "**OFF-TV REMOTE**" (Default mode), "**SAMSUNG-TV REMOTE**", "**ALL-TV REMOTE**".

Remote Control Button	Display	Status
	(Default mode) OFF-TV REMOTE 	Disable the TV remote control.
	SAMSUNG-TV REMOTE 	Enable a Samsung TV's IR remote control.
	ALL-TV REMOTE 	Enable a third-party TV's IR remote control.

04 CONNECTING THE SOUNDBAR

Connecting Electrical Power

Use the power components to connect the Subwoofer and Soundbar to an electrical outlet in the following order:

- For more information about the required electrical power and power consumption, refer to the label attached to the product. (Label: Bottom of the Soundbar Main Unit)
1. Connect the power cord to the Subwoofer.
 2. Connect the power cord to the AC/DC adapter. Connect the AC/DC adapter (with the power cord) to the Soundbar.
 3. Connect power to the Soundbar and Subwoofer.
 - Connect power to the Subwoofer first. The Subwoofer will be automatically connected when turning on the Soundbar.

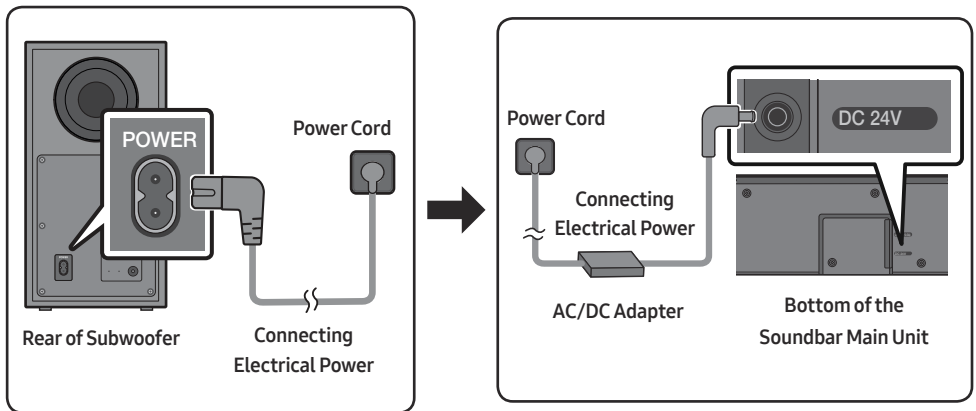

- Make sure to rest the AC/DC Adapter flat on a table or the floor. If you place the AC/DC Adapter so that it is hanging with the AC cord input facing upwards, water or other foreign substances could enter the Adapter and cause the Adapter to malfunction.
- If you unplug and reconnect the power cord when the product is turned on, the Soundbar turns on automatically.

Manually connecting the Subwoofer if automatic connection fails

Before performing the manual connection procedure below:

- Check whether the power cables for the Soundbar and subwoofer are connected properly.
- Make sure that the Soundbar is turned on.

1. Press and hold **ID SET** on the rear of the subwoofer for at least 5 seconds.
 - The red indicator on the rear of the subwoofer turns off and the blue indicator blinks.

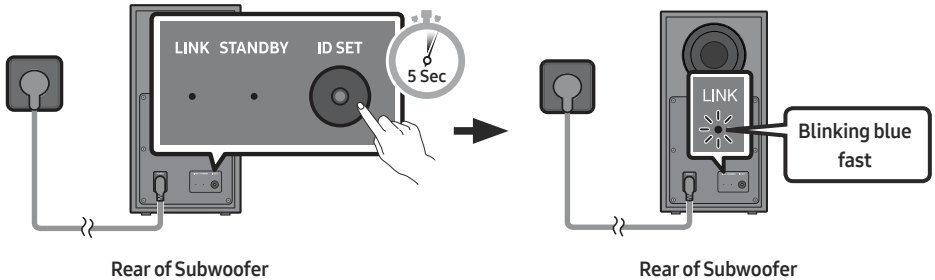

2. Press and hold the **Up** button on the remote control for at least 5 seconds.
 - The **ID SET** message appears on the display of the Soundbar for a moment, and then it disappears.
 - The Soundbar will automatically power on when **ID SET** is complete.

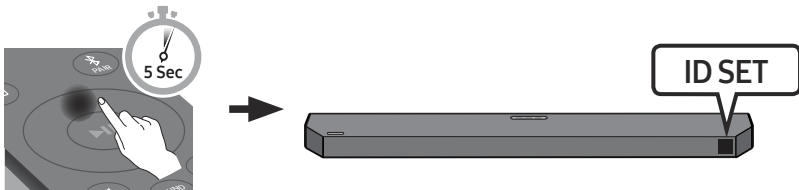

3. Check if the LINK LED is solid blue (connection complete).

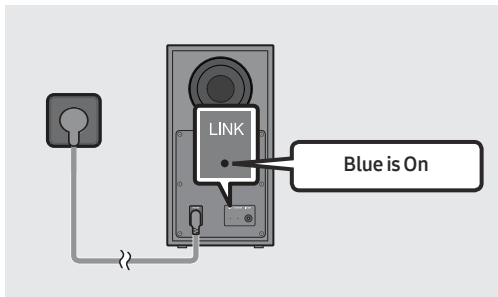

The LINK LED indicator stops blinking and glows a solid blue when a connection is established between the Soundbar and the Wireless Subwoofer.

LED Indicator Lights on the Rear of Subwoofer

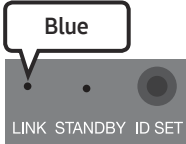
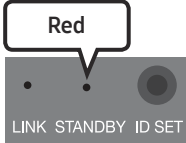
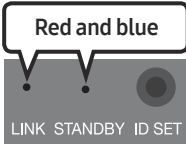
LED	Status	Description	Resolution
	On	Successfully connected (normal operation)	-
	Blinking	Recovering the connection	Check if the power cable attached to the main Soundbar unit is connected properly or wait about 5 minutes. If blinking persists, try manually connecting the subwoofer. See page 16.
	On	Standby (with the Soundbar main unit turned off)	Check if the power cable attached to the main Soundbar unit is connected properly.
		Connection failed	Connect again. See the instructions for manual connection on page 16.
	Blinking	Malfunction	See the contact information for the Samsung Service Centre in this manual.

NOTES

- Before moving or installing this product, be sure to turn off the power and disconnect the power cord.
- If the main unit is powered off, the wireless subwoofer will go into stand-by mode and the STANDBY LED on the rear of the sub-woofer will turn red after blinking blue several times.
- If you use a device that uses the same frequency as the Soundbar near the Soundbar, interference may cause some sound interruption.
- The maximum transmission distance of the main unit's wireless signal is about 10 m, but may vary depending on your operating environment. If a steel-concrete or metallic wall is between the main unit and the wireless subwoofer, the system may not operate at all because the wireless signal cannot penetrate metal.

 **CAUTION**

- Wireless receiving antennas are built into the wireless subwoofer. Keep the unit away from water and moisture.
- For optimal listening performance, make sure that the area around the wireless subwoofer and the Wireless Rear Speakers (sold separately) are clear of any obstructions.

Connecting the Samsung Wireless Rear Kit to your Soundbar

Expand to true wireless surround sound by connecting the Samsung Wireless Rear Speaker Kit (SWA-9200S sold separately) to your Soundbar.

For detailed information on connections, see the Samsung Wireless Rear Speaker Kit manual.

05 CONNECTING TO A TV

Method 1. Connecting with HDMI

Connecting the TV that supports HDMI ARC/eARC (Audio Return Channel/Enhanced Audio Return Channel)

⚠ CAUTION

- When both the HDMI cable and optical cable are connected, the HDMI signal is received first.
- To connect the HDMI cable between the TV and Soundbar, be sure to connect the terminals marked ARC or eARC. Otherwise, the TV sound output may not work.
- The recommended cable is **High Speed HDMI Cable with Ethernet**.
- When connecting a TV that supports the eARC function, “**TV eARC**” appears on the display and the sound is heard.
- Dolby Atmos®/DTS:X is supported in the ARC/eARC function.

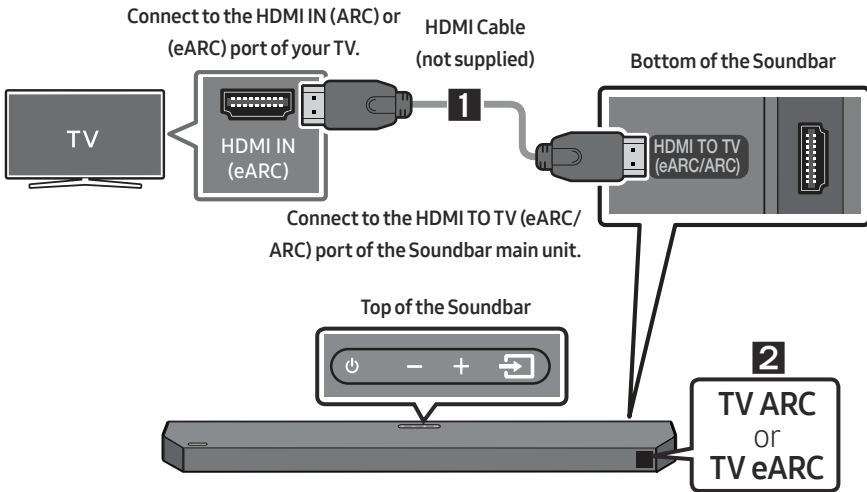

1. With the Soundbar and TV turned on, connect the HDMI cable (not supplied) as shown in the figure.
2. “**TV ARC**” or “**TV eARC**” appears in the display window of the Soundbar main unit and the Soundbar plays TV sound.
 - “**TV eARC**” is displayed when the eARC function in the TV setting is On.

- To connect with eARC, the eARC function in the TV menu should be set to On. Refer to the TV user manual for details on setting. (e.g. Samsung TV : Home (🏠) → Menu → Settings (⚙️) → All Settings (⚙️) → Sound → Expert Settings → HDMI-eARC Mode (Auto))
- If TV sound is inaudible, press the  (**Source**) button on the remote control or on the top of the Soundbar to switch to “**D.IN**” mode. The screen displays “**D.IN**” and “**TV ARC**” or “**TV eARC**” in sequence, and TV sound is played.
- If “**TV ARC**” or “**TV eARC**” does not appear in the display window of the Soundbar main unit, confirm that the HDMI cable (not supplied) is connected to the correct port.
- Use the volume buttons on the TV’s remote control to change the volume on the Soundbar.

NOTES

- When you connect the TV that supports the HDMI ARC/eARC (Audio Return Channel/Enhanced Audio Return Channel) to the Soundbar with an HDMI cable, you can transmit the digital video and audio data without connecting a separate optical cable.
- We recommend you use a coreless HDMI cable if possible. If you use a cored HDMI cable, use one with a diameter that is less than 14 mm.
- This function is not available if the HDMI cable does not support ARC or eARC.
- ARC and eARC differ in bandwidth. eARC that is enhanced version of the audio return channel has significantly higher bandwidth than ARC. Higher bandwidth increases the amount of data that can be transmitted. So, with the eARC channel, you can enjoy the sound through formats such as Dolby Atmos® and DTS:X.
- When the audio in a broadcast is encoded in Dolby Digital and the “Digital Output Audio Format” on your TV is set to PCM, we recommend that you change the setting to Dolby Digital. When the setting on the TV is changed, you will experience better sound quality. (The TV menu may use different words for Dolby Digital and PCM depending on the TV manufacturer.)

Method 2. Connecting using an Optical Cable

Pre-connection Checklist

- When both the HDMI cable and optical cable are connected, the HDMI signal is received first.
- When you use an optical cable and the terminals have covers, be sure to remove the covers.

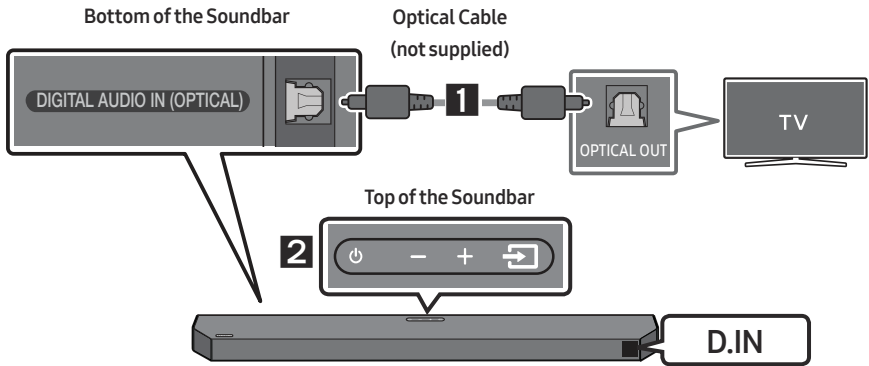

1. Connect the **DIGITAL AUDIO IN (OPTICAL)** port on the Soundbar to the OPTICAL OUT port of the TV with a digital Optical Cable (not supplied).
2. Press the  (**Source**) button on the top panel or remote control, and then select the "**D.IN**" mode.
3. The TV sound is played from the Soundbar.

Using the Q-Symphony Function

For Q-Symphony, the Soundbar syncs with a Samsung TV to output sound through two devices for optimum surround effect. When the Soundbar is connected, the menu, “**TV+Soundbar**” appears under the **Sound Output** menu of the TV. Select the corresponding menu.

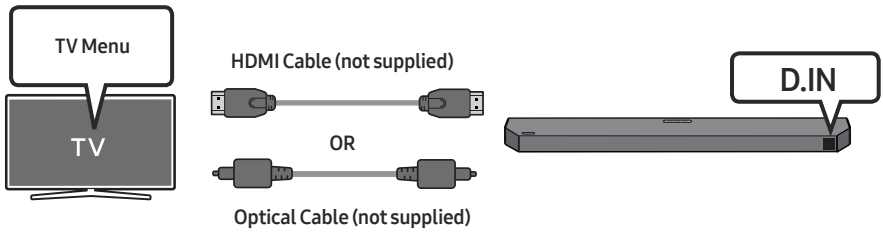

- TV menu example: **TV + [AV] Soundbar series name (HDMI)**

NOTES

- It can operate according to the Codec supported by TV.
- This function is supported only when the HDMI Cable (not supplied) or Optical Cable (not supplied) is connected.
- The message displayed may differ with the TV model.
- This function is available in some Samsung TVs and some Soundbar models.

Method 3. Connecting via Bluetooth

When a TV is connected using Bluetooth, you can hear stereo sound without the hassle of cabling.

- Only one TV can be connected at a time.

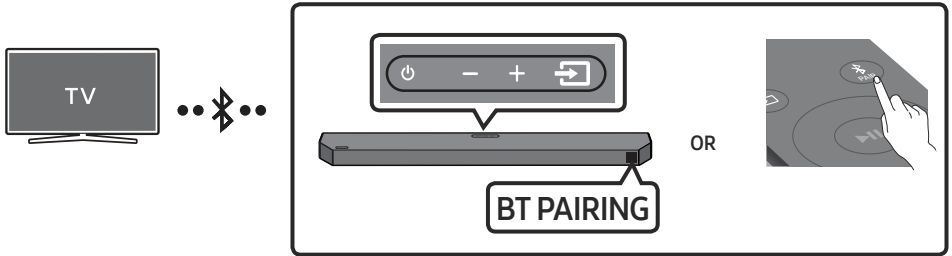

The initial connection

1. Press the **PAIR** button on the remote control to enter the “**BT PAIRING**” mode.

(OR) a. Press the **Source** button on the top panel and then select “**BT**”.

“**BT**” changes to “**BT PAIRING**” in a few seconds automatically or changes to “**BT READY**” if there is a connect record.

- b. When “**BT READY**” appears, press and hold the **Source** button on the top panel of the Soundbar for more than 5 seconds to display “**BT PAIRING**”.

2. Select Bluetooth mode on the TV. (For more information, see the TV’s manual.)

3. Select “**Soundbar Q6C-Series(Bluetooth)**” from the list on TV’s screen.

An available Soundbar is indicated with “**Need Pairing**” or “**Paired**” on the TV’s Bluetooth device list. To connect the TV to the Soundbar, select the message, and then establish a connection.

- When the TV is connected, [TV Name] → “**BT**” appears on the Soundbar’s front display.

4. You can now hear TV sound from the Soundbar.

- After you have connected the Soundbar to your TV the first time, use the “**BT READY**” mode to reconnect.

If the device fails to connect



- If a previously connected Soundbar listing (e.g. “**Soundbar Q6C-Series(Bluetooth)**”) appears in the list, delete it.
- Then repeat steps 1 through 3.

Disconnecting the Soundbar from the TV

Press the  (**Source**) button on the top panel or on the remote control and switch to any mode but “**BT**”.

- Disconnecting takes time because the TV must receive a response from the Soundbar. (The time required may differ, depending on the TV model.)
- To cancel the automatic Bluetooth connection between the Soundbar and TV, press the **Left** button on the remote control for 5 seconds with the Soundbar in “**BT READY**” status. (Toggle On → Off)

What is the difference between BT READY and BT PAIRING?

- **BT READY** : In this mode, you can reconnect TV or mobile device that was connected before.
- **BT PAIRING** : In this mode, you can connect a new device to the Soundbar. (Press the  **PAIR** button on the remote control or press and hold the  (**Source**) button on the top of the Soundbar for more than 5 seconds while the Soundbar is in “**BT**” mode.)

Notes on Bluetooth connection

- Locate a new device within 1 m to connect via Bluetooth communication.
- If asked for a PIN code when connecting a Bluetooth device, enter <0000>.
- In Bluetooth connection mode, the Bluetooth connection will be lost if the distance between the Soundbar and the Bluetooth device exceeds 10 m.
- The Soundbar automatically turns off after 18 minutes in the Ready state.
- The Soundbar may not perform Bluetooth search or connection correctly under the following circumstances:
 - If there is a strong electrical field around the Soundbar.
 - If several Bluetooth devices are simultaneously paired with the Soundbar.
 - If the Bluetooth device is turned off, not in place, or malfunctions.
- Electronic devices may cause radio interference. Devices that generate electromagnetic waves must be kept away from the Soundbar main unit - e.g., microwaves, wireless LAN devices, etc.

06 CONNECTING AN EXTERNAL DEVICE

Method 1. Connecting using an HDMI Cable (Capable of Dolby Atmos®/DTS:X decoding and playback)

Pre-connection Checklist

- If the Audio Output options include Secondary Audio, make sure Secondary Audio is set to Off.
- Make sure that the content supports Dolby Atmos®/DTS:X.

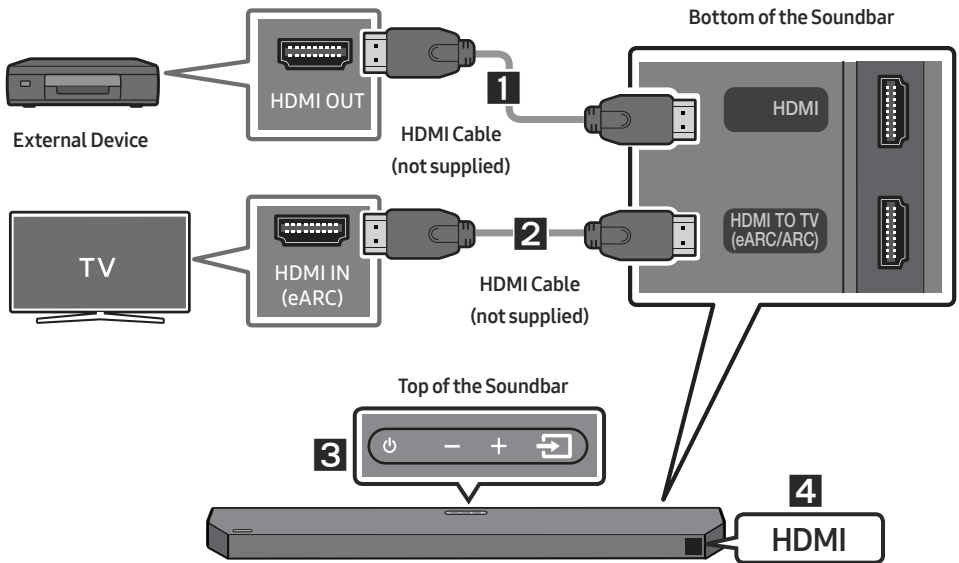

1. Connect an HDMI cable (not supplied) from the **HDMI** port on the bottom of the Soundbar to the HDMI OUT port on your digital device.
2. Connect an HDMI cable (not supplied) from the **HDMI TO TV (eARC/ARC)** port on the bottom of the Soundbar to the HDMI IN (eARC) port on your TV.
3. Press the  (**Source**) button on the top panel or on the remote control, and then select "HDMI".
4. "HDMI" mode is displayed on the Soundbar display panel and sound plays.

NOTES

- **When you use Dolby Atmos®/DTS:X:** If the input source is Dolby Atmos®/DTS:X, refer to “Output specifications for the different sound effect modes” on page 13.
- When Dolby Atmos® is activated, “**DOLBY ATMOS**” appears in the front display.
- When DTS:X is activated, “**DTS:X**” appears in the front display.
- **Configuring Dolby Atmos®/DTS:X on your BD player or other device.**

Open the audio output options on the settings menu of your BD player or other device and make sure that “No Encoding” is selected for Bitstream. For example, on a Samsung BD Player, go to Home Menu → Sound → Digital Output and then select Bitstream (unprocessed).

- HDMI Pass-Through is that the Soundbar plays the audio from the source through its own speakers and sends the unaltered video signal to a TV via the second HDMI cable.

Supported UHD Signals Specification (3840 x 2160p)

Frame rate (fps)	Colour depth	RGB 4:4:4	YCbCr 4:4:4	YCbCr 4:2:2	YCbCr 4:2:0
< 60	8 bit	○	○	○	○
	10 bit	-	-	○	○
	12 bit	-	-	○	○
120	8 bit	-	-	-	-
	10 bit	-	-	-	-

- Supported specification may vary depending on the connected external device or usage conditions.

Method 2. Connecting using an Optical Cable

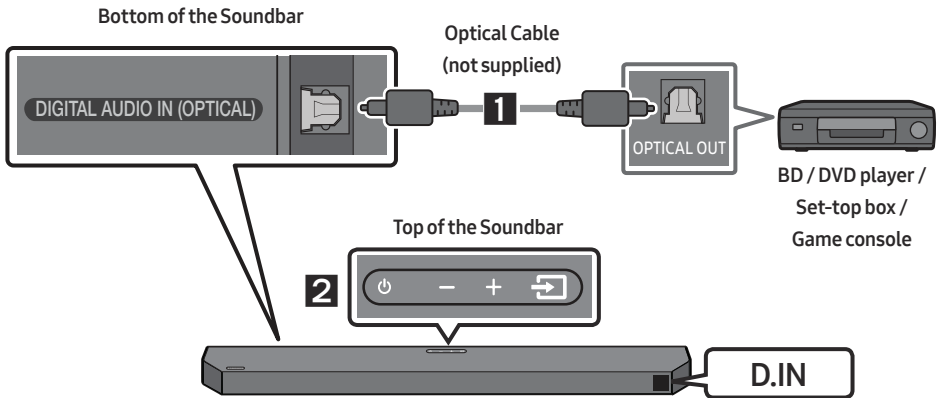

1. Connect the **DIGITAL AUDIO IN (OPTICAL)** port on the Soundbar and the OPTICAL OUT port on the external device with the optical cable (not supplied), as shown in the figure.
2. Select “**D.IN**” mode by pressing the  (**Source**) button on the top panel or on the remote control.
3. The external device sound is output from the Soundbar.

07 CONNECTING A USB DRIVE

You can play music files located on USB drive through the Soundbar.

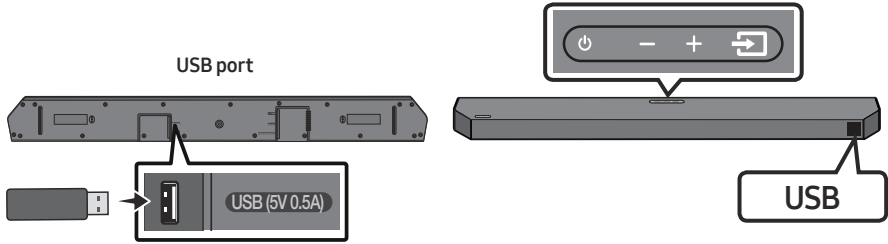

1. Connect the USB drive to the USB port on the bottom of the product.
2. Press the  (**Source**) button on the top panel or on the remote control, and then select “USB”.
3. “USB” appears in the display screen.
4. Play music files from the USB drive through the Soundbar.
 - The Soundbar automatically turns off (Auto Power Down) if there is no audio signal from USB drive or no USB drive connection for more than 18 minutes.

File Format Type Compatibility list

Extension	Codec	Sampling Rate	Bit Rate
*.mp3	MPEG1 Layer2	32kHz ~ 48kHz	32kbps ~ 320kbps
	MPEG1 Layer3	32kHz ~ 48kHz	32kbps ~ 320kbps
	MPEG2 Layer3	16kHz ~ 24kHz	8kbps ~ 160kbps
	MPEG2.5 Layer3	8kHz ~ 12kHz	8kbps ~ 160kbps
*.wma	WMA7/8/9 (Audio Only)	32kHz ~ 48kHz	32kbps ~ 320kbps
*.ogg	Vorbis	32kHz ~ 48kHz	45kbps ~ 500kbps
*.aac *.m4a *.mp4	AAC-LC (MPEG2/MPEG4 Audio Only)	32kHz ~ 48kHz	32kbps ~ 320kbps
*.wav	LPCM	32kHz ~ 192kHz	1,024kbps ~ 9,216kbps
*.flac	FLAC	32kHz ~ 192kHz	162kbps ~ 8,100kbps
*.aiff	AIFF	32kHz ~ 192kHz	1,024kbps ~ 9,216kbps

- If there are too many folders (about 200) and files (about 2000) stored on the USB drive, it may take the Soundbar some time to access and play files.
- Supported USB file system : FAT16, FAT32, NTFS

08 CONNECTING A MOBILE DEVICE

Connecting via Bluetooth

When a mobile device is connected using Bluetooth, you can hear stereo sound without the hassle of cabling.

- When you connect a paired Bluetooth device with the Soundbar off, the Soundbar automatically turns on.
- The connection is limited to one TV or two Bluetooth devices at the same time.

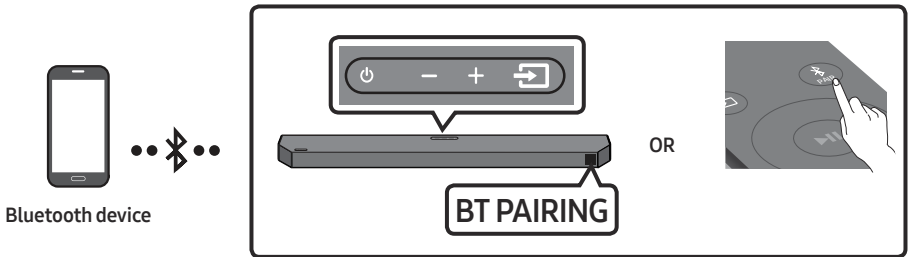

The initial connection

- When connecting to a new Bluetooth device, make sure the device is within 1 m distance.

1. Press the **PAIR** button on the remote control to enter the **"BT PAIRING"** mode.

(OR) a. Press the **Source** button on the top panel and then select **"BT"**.

"BT" changes to **"BT PAIRING"** in a few seconds automatically or changes to **"BT READY"** if there is a connect record.

b. When **"BT READY"** appears, press and hold the **Source** button on the top panel of the Soundbar for more than 5 seconds to display **"BT PAIRING"**.

2. On your device, select **"[AV]Samsung Soundbar Q6C-Series"** from the list that appears.

- When the Soundbar is connected to the Mobile device, **[Mobile Device Name] → "BT"** appears in the front display.



3. Play music files from the device connected via Bluetooth through the Soundbar.

- After you have connected the Soundbar to your mobile device the first time, use the **"BT READY"** mode to reconnect.

If the device fails to connect

- If you have an existing Soundbar (e.g., “[AV]Samsung Soundbar Q6C-Series”) on the list of speakers on the Mobile device, delete it.
- Then repeat steps 1 and 2.

What is the difference between BT READY and BT PAIRING?

- **BT READY** : In this mode, you can reconnect TV or mobile device that was connected before.
- **BT PAIRING** : In this mode, you can connect a new device to the Soundbar. (Press the  PAIR button on the remote control or press and hold the  (Source) button on the top of the Soundbar for more than 5 seconds while the Soundbar is in “BT” mode.)

Notes on Bluetooth connection

- Locate a new device within 1 m to connect via Bluetooth communication.
- If asked for a PIN code when connecting a Bluetooth device, enter <0000>.
- In Bluetooth connection mode, the Bluetooth connection will be lost if the distance between the Soundbar and the Bluetooth device exceeds 10 m.
- The Soundbar automatically turns off after 18 minutes in the Ready state.
- The Soundbar may not perform Bluetooth search or connection correctly under the following circumstances:
 - If there is a strong electrical field around the Soundbar.
 - If several Bluetooth devices are simultaneously paired with the Soundbar.
 - If the Bluetooth device is turned off, not in place, or malfunctions.
- Electronic devices may cause radio interference. Devices that generate electromagnetic waves must be kept away from the Soundbar main unit - e.g., microwaves, wireless LAN devices, etc.
- The Soundbar supports SBC data (44.1kHz, 48kHz).
- Connect only to a Bluetooth device that supports the A2DP (AV) function.
- You cannot connect the Soundbar to a Bluetooth device that supports only the HF (Hands Free) function.
- Once you have paired the Soundbar to a Bluetooth device, selecting “[AV]Samsung Soundbar Q6C-Series” from the device’s scanned devices list will automatically change the Soundbar to “BT” mode.
 - Available only if the Soundbar is listed among the Bluetooth device’s paired devices.
(The Bluetooth device and the Soundbar must have been previously paired at least once.)
- The Soundbar will appear in the Bluetooth device’s searched devices list only when the Soundbar is displaying “BT READY”.
- When connecting the Soundbar to a Bluetooth device, place them as close to each other as possible.
- The farther the Soundbar and Bluetooth device are from each other, the lower the sound quality will become. The Bluetooth connection may disconnect when the devices are out of the effective range.
- The Bluetooth connection may not function as intended in areas with poor reception.

- A Bluetooth device may experience noise or malfunction under in the following conditions:
 - When the body is in contact with the signal transceiver on the Bluetooth device or Soundbar
 - In corners or when there is an obstacle in proximity, such as a wall or partition, where electrical changes may occur.
 - When exposed to radio interferences by other products operating on the same frequency ranges, such as medical equipment, microwave ovens, and wireless LAN devices.
 - Obstacles such as doors and walls may still impact the sound quality even when the devices are within the effective range.
- Note that your Soundbar cannot be paired with other Bluetooth devices while using the Bluetooth option.
- This wireless device may cause electrical interference during operation.

Bluetooth Power On (SOUND MODE)

If a previously paired Bluetooth device tries to pair with the Soundbar when the Bluetooth Power On function is on and the Soundbar is turned off, the Soundbar turns on automatically.

1. Press and hold the **SOUND MODE** button for more than 5 seconds on the remote while the Soundbar is turned on.
2. “**ON-BLUETOOTH POWER**” appears on the Soundbar’s display.

Disconnecting the Bluetooth device from a Soundbar

You can disconnect a Bluetooth device from the Soundbar. For instructions, see the Bluetooth device’s user manual.

- The Soundbar will be disconnected.
- When the Soundbar is disconnected from the Bluetooth device, the Soundbar will display “**BT DISCONNECTED**” on the front display.

Disconnecting the Soundbar from the Bluetooth device

Press the  (**Source**) button on the top panel or on the remote control, and then change to any mode except “**BT**”.

- Disconnecting takes time because the Bluetooth device must receive a response from the Soundbar. (Disconnection time may differ, depending on the Bluetooth device)
- When the Soundbar is disconnected from the Bluetooth device, the Soundbar will display “**BT DISCONNECTED**” on the front display.

Bluetooth Multi connection

The Soundbar can be connected to 2 Bluetooth devices at the same time.

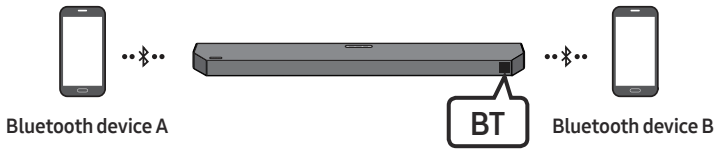

1. Connect the Soundbar to up to two Bluetooth devices. (See page 28)
2. Play music from one of the connected Bluetooth devices while two devices are connected.
3. If music is played from the Bluetooth device “B” while playing from the device “A”, the music is started playing on the device “B” and automatically being stopped/paused playback on the device “A”.
4. In versions prior to AVRCP V1.4, the switching time of the device playing music may be delayed.

NOTES

- The device can be switched by notification or alarm on some devices.
- Some devices do not support Bluetooth multi connection.
- “**BT PAIRING**” mode stops when no device is paired within 3 minutes.
- Switching devices may take about 7 seconds on some apps.
- If you attempt to connect a 3rd Bluetooth device, the A or B devices will be disconnected. (A device that is not currently playing will be disconnected.)
- Only one Samsung TV, or 2 Bluetooth devices can be connected at the same time.
- The Soundbar will be disconnected from Bluetooth devices when it receives a connection request from a Samsung TV.

Using Tap Sound

Tap the Soundbar with your mobile device to play audio from the mobile device through the Soundbar.

- This function may not be supported, depending on the mobile device.
- This function is only compatible with Samsung mobile devices with Android 8.1 or later.

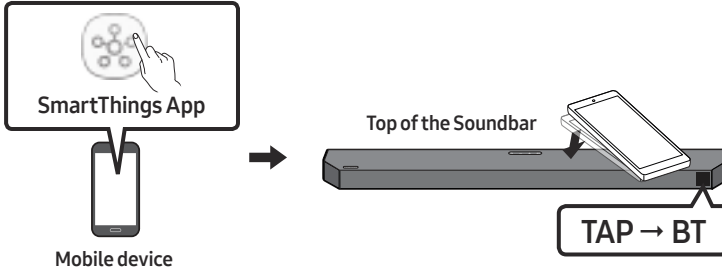

1. Turn on the **Tap Sound** function on your mobile device.
 - For details on how to turn on the function, refer to “**Enable the Tap Sound function**” below.
2. Tap the Soundbar with the mobile device. Select “**Start now**” in the displayed message window. A connection is established between the mobile device and Soundbar via Bluetooth.
3. Play audio from the mobile device through the Soundbar.
 - This function connects a mobile device to the Soundbar via Bluetooth by detecting vibration that occurs when the device touches the Soundbar.
 - Make sure the mobile device does not tap a sharp corner of the Soundbar. The Soundbar or mobile device may become scratched or damaged.
 - It is recommended that the mobile device be covered with a case. Lightly tap the wide area in the upper portion of the Soundbar, without using excessive force.
 - To use this function, update the **SmartThings** app to the latest version. The function may not be supported, depending on the app version.

Enable the Tap Sound function

Use the **SmartThings** app to turn on the **Tap View, Tap Sound** function.

1. On the mobile device, run the **SmartThings** app.
2. Select (☰ → ⚙) in the **SmartThings** app screen displayed on the mobile device.
3. Set “**Tap View, Tap Sound**” to On to allow the function to work when a mobile device moves close to the Soundbar.

NOTES

- When the mobile device is in power-saving mode, the **Tap Sound** function does not work.
- The **Tap Sound** function may not work if there are devices near the Soundbar that cause radio interference such as electric devices. Make sure devices that may cause radio interference are placed at a sufficient distance away from the Soundbar.

09 INSTALLING THE WALL MOUNT

Wallmount Components

Installation Precautions

- Install on a vertical wall only.
- Do not install in a place with high temperature or humidity.
- Verify whether the wall is strong enough to support the product's weight. If not, reinforce the wall or choose another installation point.
- Purchase and use the fixing screws or anchors appropriate for the kind of wall you have (plaster board, iron board, wood, etc.). If possible, fix the support screws into wall studs.
- Purchase wall mounting screws according to the type and thickness of the wall you want to mount the Soundbar on.
 - Diameter: M5
 - Length: 35 mm or longer recommended.
- Connect cables from the unit to external devices before you install the Soundbar on the wall.
- Make sure the unit is turned off and unplugged from the power source before you install it. Otherwise, it may cause an electric shock.

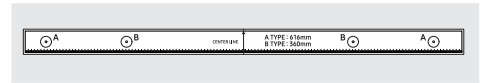

Wall Mount Guide



Holder-Screw

Screw



Bracket-Wall Mount

1. Place the **Wall Mount Guide** against the wall surface.
 - The **Wall Mount Guide** must be level.
 - If your TV is mounted on the wall, install the Soundbar at least 5 cm below the TV.

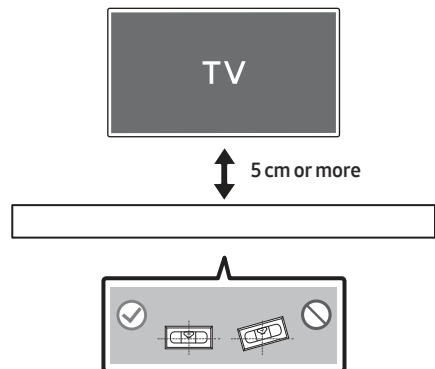

2. Align the **Wall Mount Guide's Centre Line** with the centre of your TV (if you are mounting the Soundbar below your TV), and then fix the **Wall Mount Guide** to the wall using tape.

- If you are not mounting below a TV, place the **Centre Line** in the centre of the installation area.

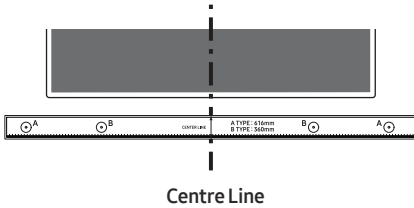

3. Push a pen tip or sharpened pencil tip through the centre of the **A-TYPE** images on each end of the Guide to mark the holes for the supporting screws, and then remove the **Wall Mount Guide**.

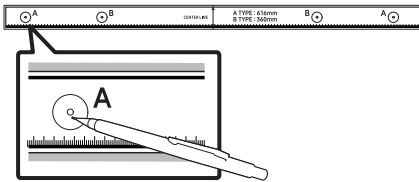

4. Using an appropriately sized drill bit, drill a hole in the wall at each marking.

- If the markings do not correspond to the positions of studs, make sure you insert appropriate anchors into the holes before you insert the support screws. If you use anchors, make sure the holes you drill are large enough for the anchors you use.

5. Push a screw (not supplied) through each **Holder-Screw**, and then screw each screw firmly into a support screw hole.

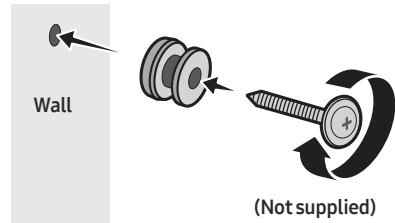

6. Install the 2 **Bracket-Wall Mounts** in the correct orientation on the bottom of the Soundbar using 2 **Screws**.

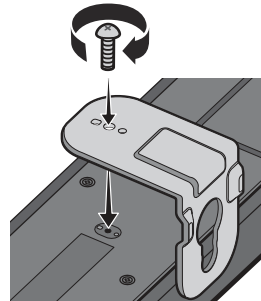

- When assembling, make sure the hanger part of the **Bracket-Wall Mounts** are located behind the rear of the Soundbar.

Rear of Soundbar

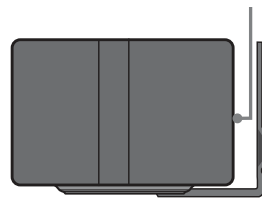

Right end of Soundbar

7. Install the Soundbar with the attached **Bracket-Wall Mounts** by hanging the **Bracket-Wall Mounts** on the **Holder-Screws** on the wall.

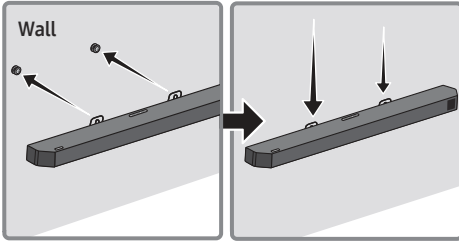

8. Slide the Soundbar down as shown below so that the **Bracket-Wall Mounts** rest securely on the **Holder-Screws**.

- Insert the **Holder-Screws** into the wide (bottom) part of the **Bracket-Wall Mounts**, and then slide the **Bracket-Wall Mounts** down so that the **Bracket-Wall Mounts** rest securely on the **Holder-Screws**.

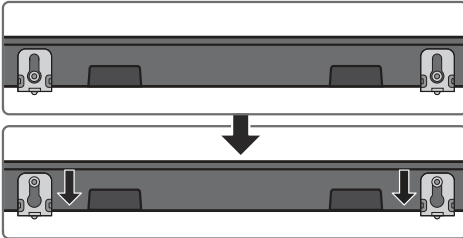

10 INSTALLING THE SOUNDBAR IN FRONT OF TV

Place the Soundbar on a TV stand.

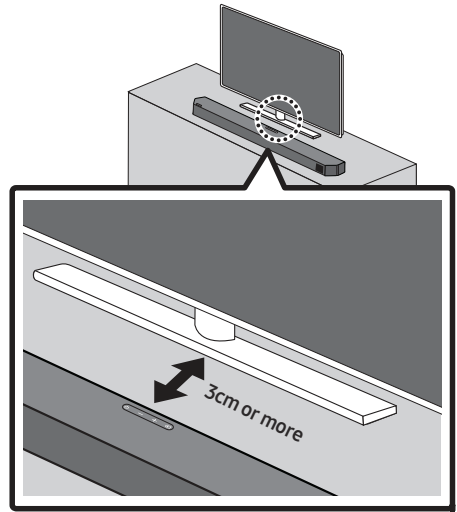

As illustrated in the image, align the centre of the Soundbar with the centre of the TV, carefully place the Soundbar onto the TV stand. For optimal sound quality, position the Soundbar at least 3 cm away from the TV front.

NOTES

- Make sure the Soundbar is placed on a flat and solid surface.
- Insufficient gap from the TV may cause acoustic problems.

11 SOFTWARE UPDATE

Samsung may offer updates for the Soundbar's system firmware in the future.

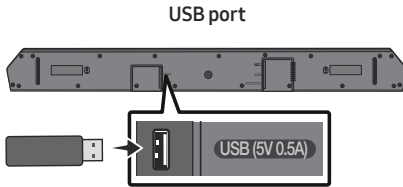

If an update is offered, you can update the firmware by connecting a USB drive with the firmware update stored on it to the USB port on your Soundbar.

USB Update

After the update completes, all your customized user settings are maintained.

1. Connect a USB drive to the USB port on your computer.

Important: Make sure there are no music files on the USB drive. This may cause the firmware update to fail.

2. Go to (www.samsung.com) → search for the model name from the customer support menu option.
 - For more information about update, refer to Upgrade Guide.
3. Download the upgrade file (USB type).
4. Unzip the downloaded upgrade file and copy the *.bin file to the root directory of the USB drive.

5. Turn off the Soundbar and connect the USB drive containing the firmware update to the USB port on the Soundbar.
6. Turn on the Soundbar and press the  (**Source**) button to select USB source. "UPGR" will be displayed, this may take up to 3 minutes.

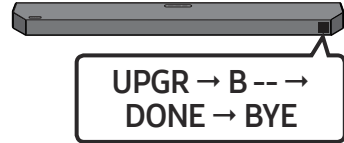

- The process of firmware update is displayed **UPGR** → **B** -- → **DONE** → **BYE** in sequence, B or H can be displayed according to the firmware that is updated.

NOTES

- Soundbar is rebooted automatically when the update is completed.
- This product has a DUAL BOOT function. If the firmware fails to update, you can update the firmware again.
- During update, do not turn it off or remove the USB.
- If update does not proceed, disconnect and reconnect the Soundbar power cord.
- When the latest version is installed, no update is performed.
- Depending on the USB type, update may not be supported.
- If the connection to the subwoofer is not re-established automatically after the update, refer to page 16.
- If the software update fails, check if the USB drive is defective.
- Mac OS users should use MS-DOS (FAT) as the USB format.

Reset

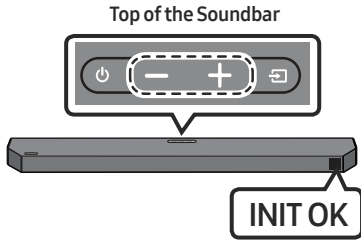

With the Soundbar on, press the **— + (Volume)** buttons on the top of the Soundbar at the same time for at least 5 seconds. **"INIT OK"** appears on the display and then the Soundbar is reset.

CAUTION

- All the settings of the Soundbar are reset.
Be sure to perform this only when a reset is required.

12 TROUBLESHOOTING

Before seeking assistance, check the following.

Soundbar does not turn on.

- Check whether the power cord of the Soundbar is correctly inserted into the outlet.

Soundbar works erratically.

- After removing the power cord, insert it again.
- Unplug the power cord and plug it back into the external device and try again.
- If there is no signal, the Soundbar automatically turns off after a certain period of time. Turn on the power. (See page 7.)

If the remote control does not work.

- Point the remote directly at the Soundbar.
- Replace the batteries with new ones.

Soundbar does not output any sound.

- The volume of the Soundbar is too low or muted. Adjust the volume.
- When any external device (STB, Bluetooth device, mobile device, etc.) is connected, adjust the volume of the external device.
- For sound output of the TV, select Soundbar. (Samsung TV: Home (🏠) → Menu → Settings (⚙️) → All Settings (⚙️) → Sound → Sound Output → Select Soundbar)
- The cable connection to the Soundbar may be loose. Remove the cable and connect again.
- Remove the power cord completely, reconnect, and turn the power on.
- Reset the product and try again. (See page 37.)

Subwoofer does not output any sound.

- Check whether the LED indicator on the rear of the Subwoofer is on in blue. Reconnect the Soundbar and Subwoofer if the indicator is blinking in blue or turned red. (See page 16.)
- You may experience an issue if there is an obstacle between the Soundbar and Subwoofer. Move devices to an area away from obstacles.
- Other devices sending radio frequency signals in proximity may interrupt the connection. Keep your speaker away from such devices.
- Remove and reconnect the power plug.

In case there is sound jitter, delays, or noise from the Subwoofer.

- If there are any objects between the Soundbar and Subwoofer speaker, this could cause a problem. Please reposition these to a place without interference from that object.
- There may be sound jitter or delays when the Subwoofer is far from the Soundbar. Please place it near the Soundbar.
- There may be sound jitter or delays when the Soundbar is near an instrument or electrical device that can cause radio interference. Place the Soundbar far from such devices that can cause radio interference. (E.g., wireless router)
- Change the TV network connection status from wireless to wired.

The Subwoofer volume is too low.

- The original volume of the content you are playing may be low. Try adjusting the Subwoofer level. (See page 12.)
- Bring the Subwoofer speaker closer to you.

If the TV is not connected via HDMI TO TV (eARC/ARC).

- Check whether the HDMI cable is correctly connected to the eARC terminal. (See page 19.)
- Connection may not be possible due to the connected external device (set-top box, game machine, etc.). Directly connect the Soundbar.
- HDMI-CEC may not be activated on the TV. Turn on the CEC on the TV menu. (Samsung TV: Home (🏠) → Menu → Settings (⚙️) → All Settings (⚙️) → Connection → External Device Manager → Anynet+ (HDMI-CEC) ON)
- To connect with eARC, the eARC function in the TV menu should be set to On. (Samsung TV: Home (🏠) → Menu → Settings (⚙️) → All Settings (⚙️) → Sound → Expert Settings → HDMI-eARC Mode (Auto))

There is no sound in when connecting to the TV in HDMI TO TV (eARC/ARC) mode.

- Your device is unable to play the input signal. Change the TV's audio output to PCM or AUTO. (Samsung TV: Home (🏠) → Menu → Settings (⚙️) → All Settings (⚙️) → Sound → Expert Settings → Digital Output Audio Format)

Soundbar does not connect via Bluetooth.

- When connecting a new device, switch to **"BT PAIRING"** for connection. (Press the **PAIR** button on the remote control or press the **Source** button on the body for at least 5 seconds.)
- If the Soundbar is connected to another device, disconnect that device first to switch the device.
- Reconnect it after removing the Bluetooth speaker list on the device to connect. (Samsung TV: Home (🏠) → Menu → Settings (⚙️) → All Settings (⚙️) → Sound → Sound Output → Bluetooth Speaker List)
- The automatic TV connection may be disabled. While the Soundbar is in **"BT READY"**, press and hold the **Left** button on the Soundbar remote control for 5 seconds to select **ON-TV CONNECT**. If you see **OFF-TV CONNECT**, press and hold **Left** button again for 5 seconds to switch the selection.
- Remove and reconnect the power plug, then try again.
- Reset the product and try again. (See page 37.)

Sound drops out when connected via Bluetooth.

- Some devices can cause radio interference if they are located too close to the Soundbar. e. g. microwaves, wireless routers, etc.
- If your device that is connected via Bluetooth moves too far away from the Soundbar, it may cause the sound to drop out. Move the device closer to the Soundbar.
- If a part of your body is in contact with the Bluetooth transceiver or the product is installed on metal furniture, sound may drop out. Check the installation environment and conditions for use.

Bluetooth multi connection does not work.

- When the TV is connected to the soundbar, Bluetooth multi connection may not operate. Disconnect the Soundbar from the TV and try again.
- Check whether the Bluetooth Multi connection setting is turned on. (Refer to the “**Soundbar does not connect via Bluetooth.**” section.)
- Disconnect the device currently playing, pair with the device that you want to connect, and reconnect the previous device.
- If the sound is inaudible even after connecting properly, refer to the “**Sound drops out when connected via Bluetooth.**” section.

Soundbar does not turn on automatically with the TV.

- When you turn off the Soundbar while watching TV, power synchronization with the TV is disabled. First turn off the TV.

13 LICENCE



Dolby, Dolby Atmos, and the double-D symbol are registered trademarks of Dolby Laboratories Licensing Corporation. Manufactured under license from Dolby Laboratories. Confidential unpublished works. Copyright © 2012-2021 Dolby Laboratories. All rights reserved.



For DTS patents, see <http://patents.dts.com>. Manufactured under license from DTS, Inc. or DTS Licensing Limited. DTS, DTS:X, and the DTS:X logo are registered trademarks or trademarks of DTS, Inc. in the United States and other countries. © 2021 DTS, Inc. ALL RIGHTS RESERVED.



The terms HDMI, HDMI High-Definition Multimedia Interface, HDMI Trade dress and the HDMI Logos are trademarks or registered trademarks of HDMI Licensing Administrator, Inc.



The Bluetooth® word mark and logos are registered trademarks owned by Bluetooth SIG, Inc. and any use of such marks by Samsung Electronics Co., Ltd. is under license. Other trademarks and trade names are those of their respective owners.



[ENERGY STAR]

ENERGY STAR qualified model only

- Your Samsung product is ENERGY STAR qualified in its factory default setting. Change to certain features, settings and functionality in this product can change the power consumption, possibly beyond the limits required for ENERGY STAR qualification.
- Environmental Protection Agency and Department of Energy. ENERGY STAR is a joint program of the Government agencies, designed to promote energy efficient products and practices.

Refer to www.energystar.gov for more information of the ENERGY STAR Program.

ENERGY STAR qualified model only (Applicable to Thin Client models only)

As an ENERGY STAR® Partner, SAMSUNG has determined that this product meets the ENERGY STAR® guidelines for energy efficiency.

- The ENERGY STAR Program has been to reduced greenhouse gas emissions and save energy through voluntary labeling.
- Power management setting of this product have been enabled by default, and have various timing setting from 1 minutes to 5 hours.
- The product can wake with a button press on the chassis from sleep mode.

ENERGY STAR qualified model only (The other models)

- As an ENERGY STAR Partner, Samsung has determined that this product or product models meets the ENERGY STAR guideline for energy efficiency.
-

14 OPEN SOURCE LICENCE NOTICE

To send inquiries and requests for questions regarding open sources, contact Samsung Open Source (<http://opensource.samsung.com>)

15 IMPORTANT NOTES ABOUT SERVICE

- Figures and illustrations in this User Manual are provided for reference only and may differ from actual product appearance.
- An administration fee may be charged if either
 - (a) an engineer is called out at your request and there is no defect with the product (i.e. where the user manual has not been read).
 - (b) you bring the unit to a repair centre and there is no defect with the product (i.e. where the user manual has not been read).
- You will be informed of the administration fee amount before a technician visits.

16 SPECIFICATIONS AND GUIDE

Specifications

Model Name	HW-Q600C
USB	5V/0.5A
Weight	3.8 kg
Dimensions (W x H x D)	1030.0 x 57.0 x 105.0 mm
Operating Temperature Range	+5°C to +35°C
Operating Humidity Range	10 % ~ 75 %
AMPLIFIER Rated Output power	200W (30W x 6 + 10W x 2)
Supported play formats	Dolby 5.1ch / Dolby Digital Plus / Dolby TRUE HD / Dolby ATMOS / DTS:X MA / DTS:X / DTS-HD MA / DTS-HD HRA / DTS Express / DTS 96/24 / DTS-ES / DTS Digital Surround / LPCM 8ch
Subwoofer Name	PS-WC67B
Weight	5.5 kg
Dimensions (W x H x D)	184.0 x 343.0 x 295.0 mm
AMPLIFIER Rated Output power	160W
Overall Standby Power Consumption (W)	2.0W
Bluetooth Port deactivation method	Press and hold the SOUND MODE button for more than 5 seconds to turn off Bluetooth Power function.

NOTES

- Samsung Electronics Co., Ltd reserves the right to change the specifications without notice.
- Weight and dimensions are approximate.
- Hereby, Samsung declares that this radio equipment is in compliance with Directive 2014/53/EU and the relevant UK statutory requirements. The full text of the declaration of conformity is available at the following internet address: <http://www.samsung.com> go to Support and enter the model name. This equipment may be operated in all EU countries and in the UK.

- **WIRELESS DEVICE OUTPUT POWER**

RF max transmitter power

100mW at 2.4GHz – 2.4835GHz

25mW at 5.725GHz – 5.825GHz



[Correct disposal of batteries in this product]

(Applicable in countries with separate collection systems)

This marking on the battery, manual or packaging indicates that the batteries in this product should not be disposed of with other household waste at the end of their working life. Where marked, the chemical symbols Hg, Cd or Pb indicate that the battery contains mercury, cadmium or lead above the reference levels in EC Directive 2006/66.

If batteries are not properly disposed of, these substances can cause harm to human health or the environment.

To protect natural resources and to promote material reuse, please separate batteries from other types of waste and recycle them through your local, free battery return system.



**Correct Disposal of This Product
(Waste Electrical & Electronic Equipment)**

(Applicable in countries with separate collection systems)

This marking on the product, accessories or literature indicates that the product and its electronic accessories (e.g. charger, headset, USB cable) should not be disposed of with other household waste at the end of their working life. To prevent possible harm to the environment or human health from uncontrolled waste disposal, please separate these items from other types of waste and recycle them responsibly to promote the sustainable reuse of material resources.

Household users should contact either the retailer where they purchased this product, or their local government office, for details of where and how they can take these items for environmentally safe recycling.

Business users should contact their supplier and check the terms and conditions of the purchase contract. This product and its electronic accessories should not be mixed with other commercial wastes for disposal.

For information on Samsung's environmental commitments and product specific regulatory obligations e.g. REACH, WEEE, Batteries, visit:

www.samsung.com/uk/aboutsamsung/sustainability/environment/our-commitment/data/

COMMISSION REGULATION (EU) 2019/1782

Ecodesign requirements for external power supplies :

www.samsung.com/global/ecodesign_component



UNITED KINGDOM



EIRE

This Samsung product is warranted for the period of twelve (12) months from the original date of purchase, against defective materials and workmanship. In the event that warranty service is required, you should return the product to the retailer from whom it was purchased. However, Samsung Authorised Dealers and Authorised Service Centres in other EC Countries will comply with the warranty on the terms issued to purchasers in the country concerned. In case of difficulty, details of our Authorised Service Centres are available from:

Samsung Electronics U.K. Ltd
Samsung Customer Support Centre
Selectapost 38, Sheffield, S97 3FJ
United Kingdom

United Kingdom

Tel : 0333 000 0333

www.samsung.com/uk/support

EIRE

Tel : 0818 717100

www.samsung.com/ie/support

■ WARRANTY CONDITIONS

1. The warranty is only valid if, when warranty service is required, the warranty card is fully and properly completed and is presented with the original invoice or sales slip or confirmation, and the serial number on the product has not been defaced.
2. Samsung's obligations are limited to the repair or, at its discretion, replacement of the product or the defective part. Repaired or replaced products may include new and or refurbished components and equipment.
3. Warranty repairs must be carried out by Authorised Samsung Dealers or Authorised Service Centres. No re-imburement will be made for repairs carried out by non Samsung Dealers and, any such repair work and damage to the products caused by such repair work will not be covered by this warranty.
4. This product is not considered to be defective in materials nor workmanship by reason that it requires adaptation in order to conform to national or local technical or safety standards in force in any Country other than the one for which the product was originally designed and manufactured. This warranty will not cover, and no re-imburement will be made for such adaptation nor any damage which may result.
5. This warranty covers none of the following:
 - a) Periodic check ups, maintenance and repair or replacement of parts due to normal wear and tear.
 - b) Cost relating to transport, removal or installation of the product.
 - c) Misuse, including the failure to use this product for its normal purposes or incorrect installation.
 - d) Damage caused by Lightning, Water, Fire, Acts of God, War, Public Disturbances, incorrect mains voltage, improper ventilation or any other cause beyond the control of Samsung.
6. This warranty is valid for any person who legally acquired possession of the product during the warranty period.
7. The consumers' statutory rights in any applicable national legislation whether against the retailer arising from the purchase contract or otherwise are not affected by this warranty. Unless there is national legislation to the contrary, the rights under this warranty are the consumers' sole rights and Samsung, its subsidiaries and distributors shall not be liable for indirect or consequential loss or any damage to disc based media, removable memory or any other related equipment or material.
8. Samsung shall honour warranties for all EU specification products purchased by a consumer within the following European countries listed.
 - UK, Republic of Ireland, Germany, France, Italy, Malta, Spain, Portugal, The Netherlands, Belgium, Luxembourg, Denmark, Sweden, Finland, Poland, Hungary, Czech Republic, Slovakia, Austria, Slovenia, Croatia, Estonia, Latvia, Lithuania, Greece, Cyprus, Romania, Bulgaria, Switzerland, Norway, Lichtenstein and Iceland.

SAMSUNG ELECTRONICS (U.K.) LTD.

SAMSUNG

© 2023 Samsung Electronics Co., Ltd. All rights reserved.

Contact SAMSUNG WORLD WIDE

If you have any questions or comments relating to Samsung products, please contact the SAMSUNG customer care Centre.

Country	Samsung Service Centre ☎	Web Site	Country	Samsung Service Centre ☎	Web Site
■ Europe					
UK	0333 000 0333	www.samsung.com/uk/support	CZECH	800 - SAMSUNG (800-726786)	www.samsung.com/cz/support
IRELAND (EIRE)	0818 717100	www.samsung.com/ie/support	SLOVAKIA	0800 - SAMSUNG (0800-726786)	www.samsung.com/sk/support
GERMANY	0619677 555 77	www.samsung.com/de/support	CROATIA	072726786	www.samsung.com/hr/support
FRANCE	0148 63 00 00	www.samsung.com/fr/support	BOSNIA	055 233 999	www.samsung.com/support
ITALIA	800-SAMSUNG (800.7267864)	www.samsung.com/it/support	NORTH MACEDONIA	023 207 777	www.samsung.com/mk/support
SPAIN	91 175 00 15	www.samsung.com/es/support	MONTENEGRO	020 405 888	www.samsung.com/support
PORTUGAL	210 608 098 Chamada para a rede fixa nacional Dias úteis das 9h às 20h	www.samsung.com/pt/support	SLOVENIA	080 697 267 (brezplačna številka)	www.samsung.com/si/support
LUXEMBURG	261 03 710	www.samsung.com/be_fr/support	SERBIA	011 321 6899	www.samsung.com/rs/support
NETHERLANDS	088 90 90 100	www.samsung.com/nl/support	KOSOVO	038 40 30 90	www.samsung.com/support
BELGIUM	02-201-24-18	www.samsung.com/be/support (Dutch) www.samsung.com/be_fr/support (French)	ALBANIA	045 620 202	www.samsung.com/al/support
NORWAY	21629099	www.samsung.com/no/support	BULGARIA	0800 111 31 - Безплатен за всички оператори *3000 - Цена на един градски разговор или според тарифата на мобилният оператор 09:00 до 18:00 - Понеделник до Петък	www.samsung.com/bg/support
DENMARK	707 019 70	www.samsung.com/dk/support	ROMANIA	0800872678 - Apel gratuit *8000 - Apel tarifat în rețea Program Call Center Luni - Vineri: 9 AM - 6 PM	www.samsung.com/ro/support
FINLAND	030-6227515	www.samsung.com/fi/support	CYPRUS	8009 4000 only from landline, toll free	www.samsung.com/gr/support
SWEDEN	0771-400 300	www.samsung.com/se/support	GREECE	80111-SAMSUNG (80111 726 7864) only from land line (*30) 210 6897691 from mobile and land line	
POLAND	801-172-678* lub +48 22 607-93-33* Specjalistyczna infolinia do obsługi zapytań dotyczących telefonów komórkowych: 801-672-678* * (opłata według taryfy operatora)	http://www.samsung.com/pl/support/	LITHUANIA	8-800-77777	www.samsung.com/lt/support
HUNGARY	0680SAMSUNG (0680-726-7864)	www.samsung.com/hu/support	LATVIA	8000-7267	www.samsung.com/lv/support
AUSTRIA	0800 72 67 864 (0800-SAMSUNG)	www.samsung.com/at/support	ESTONIA	800-7267	www.samsung.com/ee/support
SWITZERLAND	0800726786	www.samsung.com/ch/support (German) www.samsung.com/ch_fr/support (French)			