



## OPERATING INSTRUCTIONS

### Basic Guide

### Personal Computer

Model No. **CF-54** series

## Contents

### Getting Started

Introduction.....	2
Description of Parts .....	4
First-time Operation.....	8
Turning On / Turning Off.....	14

### Useful Information

Handling and Maintenance.....	16
Installing Software .....	20

### Troubleshooting

Troubleshooting (Basic).....	27
------------------------------	----

### Appendix

LIMITED USE LICENSE AGREEMENT .....	33
Contrat de licence d'usage limité.....	35
Specifications .....	37
LIMITED WARRANTY .....	42

# Introduction







Thank you for purchasing this Panasonic product. For optimum performance and safety, please read these instructions carefully.

In these instructions, the names are referred as follows.

**Windows 10** indicates Windows 10 Operating System.

**Windows 7** indicates Windows 7 Operating System.

## ■ Terms and illustrations in these instructions

<b>CAUTION</b> :	Conditions that may result in minor or moderate injury.
<b>NOTE</b> :	Useful and helpful information.
<b>Enter</b> :	Press [Enter] key.
<b>Fn + F5</b> :	Press and hold [Fn] key, and then press [F5] key.
<b>Windows 10</b>	
 - [All Apps] :	Click  (Start) and then click [All Apps].
<b>Windows 7</b>	
 (Start) - [All Programs] :	Click  (Start), and then click [All Programs]. You may need to double-click in some cases.
 :	Page in these Operating Instructions or in the Reference Manual.
 :	Reference to the on-screen manuals.

- Some illustrations are simplified to help your understanding and may look different from the actual unit.
- If you do not log on as an administrator, you cannot use some functions or cannot display some screens.
- Refer for the latest information about optional products to the catalogs, etc.
- In these instructions, the names and terms are referred as follows.
  - “Windows 10 Pro 64-bit” as “Windows” or “Windows 10”
  - “Windows 7 Professional 32-bit Service Pack 1” and “Windows 7 Professional 64-bit Service Pack 1” as “Windows” or “Windows 7”
  - DVD MULTI drive as “CD/DVD drive”
  - Circular media including DVD-ROM and CD-ROM as “discs”
  - “Multilanguage User Interface” as “MUI”
- **Windows 10**  
Screen messages are explained in [English (United States)].  
(Depending on the language preference, some screen messages in these instructions are different from the actual screen messages. For example, [Flight mode] may be displayed instead of [Airplane mode] in some language preference.)

## ■ Disclaimer

Computer specifications and manuals are subject to change without notice. Panasonic Corporation assumes no liability for damage incurred directly or indirectly from errors, omissions or discrepancies between the computer and the manuals.

## ■ Trademarks

Microsoft®, Windows®, the Windows logo, and IntelliMouse are registered trademarks of Microsoft Corporation of the United States and/or other countries.

Intel, Core and PROSet are either registered trademarks or trademarks of Intel Corporation.

SDXC Logo is a trademark of SD-3C, LLC.



Adobe, the Adobe logo and Adobe Reader are either registered trademarks or trademarks of Adobe Systems Incorporated in the United States and/or other countries.

Bluetooth® is a registered trademark owned by Bluetooth SIG, Inc., U.S.A. and licensed to Panasonic Corporation.

HDMI, the HDMI Logo and High-Definition Multimedia Interface are trademarks or registered trademarks of HDMI Licensing LLC in the United States and other countries.

Names of products, brands, etc., appearing in this manual are trademarks or registered trademarks of their respective own companies.

## ■ On-screen Manual

For further information about the computer, you can refer to the on-screen manual.

### ● Operating Instructions - Reference Manual

The Reference Manual contains the practical information to help you fully enjoy the computer's performance. Update it to the latest version for reference.

### ● Important Battery Tips

The Important Battery Tips will provide you with the battery information so that you can use the battery in the optimum condition to obtain longer operation time.

### ● Operating Instructions - Update the on-screen manuals

This describes the procedures to update the on-screen manual.

### ● Connect to a network

This describes the connection procedures using the network devices mounted on this unit.

To access the on-screen manuals, follow the steps below.

Double-click [Launch Manual Selector] on the desktop, and select the on-screen manual.

#### Windows 10

1. Double-click the [Panasonic PC Settings Utility] on the desktop screen, and then click [Support] - [Manual] - [Launch Manual Selector].
2. Select the manual and click [OPEN].

#### NOTE

- [Contents] tab or [Search] tab of the on-screen manuals is displayed on the left side of the window. Select tab and display the desired item.

# Description of Parts

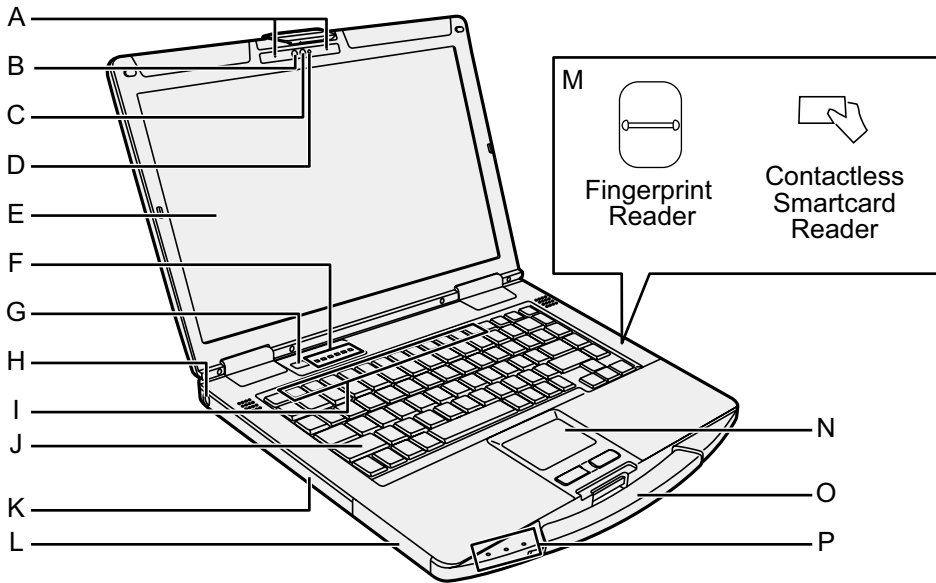

## Camera

<Only for model with camera>

→ Reference Manual "Camera"

**A: Microphone**

**B: Ambient Light Sensor**

**C: Camera Lens**

**D: Camera Indicator**

## E: LCD

<Only for model with touchscreen>

→ Reference Manual "Screen Input Operation"

## F: LED Indicator<sup>\*1</sup>

: Caps lock

: Numeric Lock (NumLk)

: Scroll Lock (ScrLk)

: Drive Indicator

: SD Memory Card Indicator

(Blinking: During access or a password is requested)

→ Reference Manual "SD Memory Card"

: Wireless ready

This indicator lights when Wireless LAN, Bluetooth, and/or Wireless WAN are connected and ready. It also lights while Windows is starting up. It does not necessarily indicate the On/Off condition of the wireless connection. When Wireless WAN is enabled and ready, this indicator lights even during sleep, hibernation or shutdown mode.

→ Connect to a network

<sup>\*1</sup> The LED indicators do not light when concealed mode is enabled.

## G: Power Switch

## H: Security Lock

A Kensington cable can be connected. For further information, read the manual that comes with the cable.

## I: Function Keys

→ Reference Manual "Key Combinations"

## J: Keyboard

## K: CD/DVD Drive<sup>\*2</sup> / PC Card Slot<sup>\*3</sup> / Battery Pack Slot 2<sup>\*4</sup> / Smart Card Slot<sup>\*5</sup>

<sup>\*2</sup> Only for model with CD/DVD drive

→ Reference Manual "CD/DVD Drive"

<sup>\*3</sup> Only for model with PC card slot

→ Reference Manual "PC Card"

<sup>\*4</sup> When using battery pack 2

→ Reference Manual "Battery Power"

<sup>\*5</sup> Only for model with smart card slot

## L: Battery Pack Slot 1

→ Reference Manual "Battery Power"

## M: Fingerprint Reader<sup>\*6</sup> / Contactless Smart Card Reader<sup>\*7</sup>

<sup>\*6</sup> Only for model with fingerprint reader

→ Reference Manual "Fingerprint Reader"

<sup>\*7</sup> Only for model with contactless smart card reader

→ Reference Manual "Contactless Smart Card Reader"

## N: Touchpad

→ Reference Manual "Touchpad"

## O: Carrying Handle

Do not use the handle if the handle is worn or damaged.

## P: LED Indicator<sup>\*1</sup>

: Power Indicator

Off: Power off/Hibernation, Green: Power on, Blinking Green: Sleep  
Blinking green rapidly: Cannot power on or resume due to low temperature.

: Battery Indicator 1

: Battery Indicator 2<sup>\*4</sup>

→ Reference Manual "Battery Power"

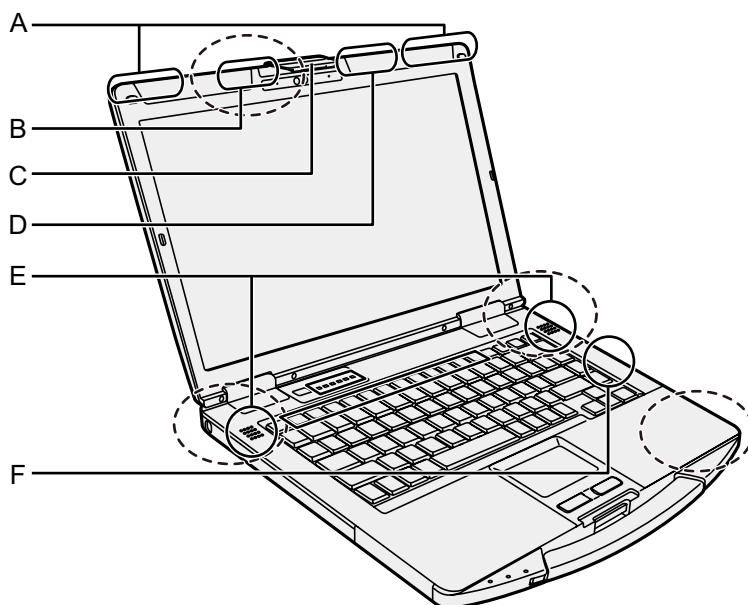

**A: Wireless WAN Antenna**

<Only for model with Wireless WAN>

→  *Connect to a network* "Wireless WAN"

**B: GPS Antenna**

<Only for model with GPS>

→  *Reference Manual* "GPS"

**C: Display Latch**

**D: Wireless LAN Antenna / Bluetooth Antenna**

<Only for model with Wireless LAN / Bluetooth>

→  *Connect to a network* "Wireless LAN"  
"Bluetooth"

**E: Speaker**

**F: Wireless LAN Antenna**

<Only for model with Wireless LAN>

→  *Connect to a network* "Wireless LAN"

**NOTE**

- This computer contains a magnet and magnetic products at the locations dashed line circled in the illustration above. Avoid leaving metallic object or magnetic media in contact with these areas.

# Description of Parts

## Right side

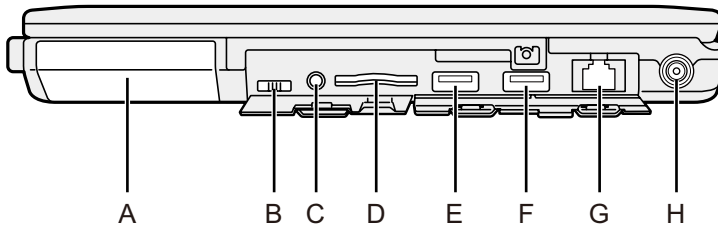

## Rear side

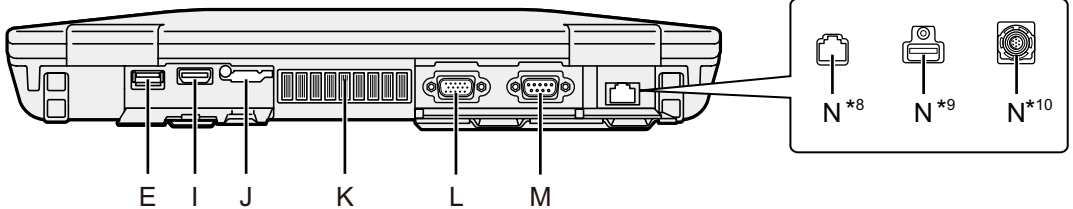

### A: Hard Disk Drive (Quick Release Drive)

→ Reference Manual "Hard Disk Drive"

### B: Wireless Switch

→ Connect to a network "Disabling/Enabling Wireless Communication"

### C: Headset Jack

A headset or headphone can be connected.

### D: SD Memory Card Slot

Keep SD Memory Cards away from infants and small children.

→ Reference Manual "SD Memory Card"

### E: USB 3.0 Ports

→ Reference Manual "USB Devices"

### F: USB 3.0 Port (USB Charging)

Do not insert any foreign object in the USB port.

→ Reference Manual "USB Devices"

### G: LAN Port

→ Connect to a network "LAN"

### H: DC-IN Jack

### I: HDMI Port

→ Reference Manual "External Display"

### J: SIM Card Slot

<Only for model with Wireless WAN>

→ Connect to a network "Wireless WAN"

### K: Ventilation Hole (Exhaust)

### L: VGA Port

<Only for model with VGA port>

→ Reference Manual "External Display"

### M: Serial Port

<Only for model with Serial port>

→ Reference Manual "Serial Port"

### N: 2nd LAN Port<sup>\*8</sup> / USB 2.0 Port<sup>\*9</sup> / Rugged USB 2.0 Port<sup>\*10</sup> / GPS<sup>\*11</sup>

<sup>\*8</sup> Only for model with 2nd LAN port

<sup>\*9</sup> Only for model with USB 2.0 port

<sup>\*10</sup> Only for model with rugged USB 2.0 port

<sup>\*11</sup> Only for model with GPS

## Bottom side

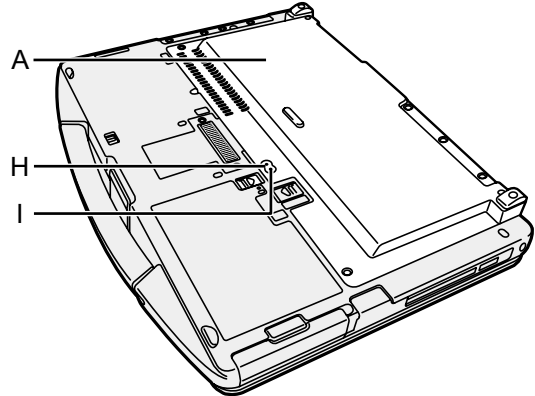
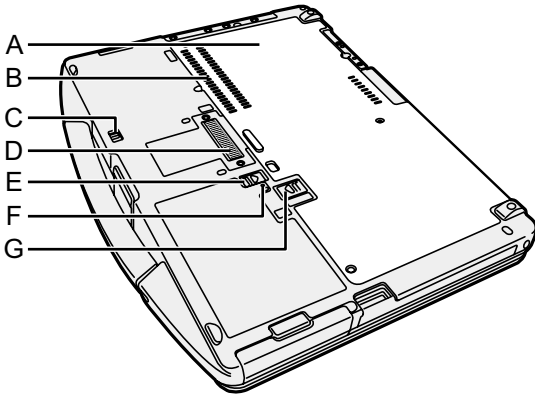

**A: Back Cover**

**B: Ventilation Hole (Intake)**

**C: Hard Disk Latch**

→  *Reference Manual* "Hard Disk Drive"

**D: Expansion Bus Connector**

→  *Reference Manual* "Port replicator"

**E: Battery Pack Latch 1**

→  *Reference Manual* "Battery Power"

**F: Battery Indicator**

→  *Reference Manual* "Battery Power"

**G: Battery Pack Latch 2**

<When using battery pack 2>

→  *Reference Manual* "Battery Power"

**H: External Antenna Connector (CH2)**

<Only for model with External Antenna Connector>

**I: External Antenna Connector (CH1)**

<Only for model with External Antenna Connector>

# First-time Operation

## ■ Preparation

① Check and identify the supplied accessories.

If you do not find the described accessories, contact your support office.

• **AC Adaptor** . . . . . 1

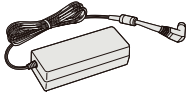

Model No: CF-AA5713A

• **AC Cord** . . . . . 1

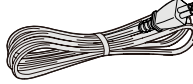

• **Battery Pack** . . . . . 1

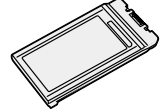

Model No: CF-VZSU0PW or  
CF-VZSU0LW

<Only for model with touchscreen>

• **Soft Cloth** . . . . . 1<sup>\*1</sup>

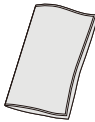

<sup>\*1</sup> Only for North America

• **OPERATING INSTRUCTIONS - Read Me First** . . . . . 1

Depending on the model, the following items are supplied.

• **Battery Pack** . . . . . 1

Model No: CF-VZSU0KW

### 1 Insert the battery pack

Insert the battery pack until it touch to the secured position.

#### CAUTION

- Make sure the latch is securely locked. Otherwise the battery pack may fall when you carry the computer.
- Do not touch the terminals of the battery pack and the computer. Doing so can make the terminals dirty or damaged, and may cause malfunction of the battery pack and the computer.

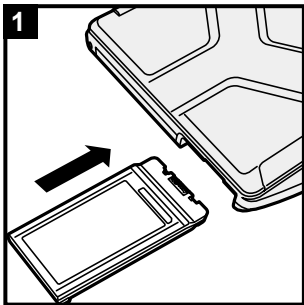

<For CF-VZSU0KW>

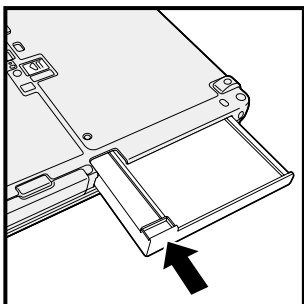



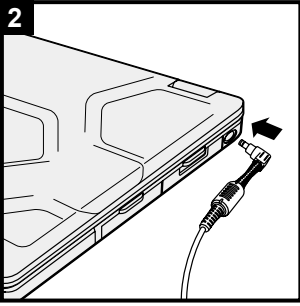

## 2 Connect your computer to a power outlet

The battery charging starts automatically.

### CAUTION

- Do not disconnect the AC adaptor and do not switch the wireless switch to on until the first-time operation procedure is completed.
- When using the computer for the first time, do not connect any peripheral device except the battery pack and AC adaptor.
- **Handling the AC adaptor**  
Problems such as sudden voltage drops may arise during periods of thunder and lightning. Since this could adversely affect your computer, an uninterruptible power source (UPS) is highly recommended unless running from the battery pack alone.
- When the DC plug is not connected to the computer, disconnect the AC cord from your electrical outlet. Power is consumed simply by having the AC adaptor plugged into an electrical outlet.

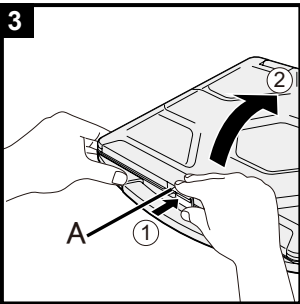

## 3 Open the display

- ① Push the top of the latch (A) to release it.
- ② Hold the side/ handle of the computer with either of your hands and then lift up the display to open.

### CAUTION

- Do not open the display wider than necessary (180° or more), and do not apply excessive pressure to the LCD. Do not open or close the computer holding the edge of the LCD segment.

# First-time Operation

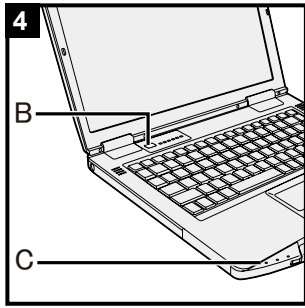

## 4 Turn on the computer

Press and hold the power switch (B) until the power indicator (C) lights.

### CAUTION

- Do not press the power switch repeatedly.
- The computer will be forcibly turned off if you press and hold the power switch for four seconds or longer.
- Once you turn off the computer, wait for ten seconds or more before you turn on the computer again.
- Do not perform the following operation until the drive indicator (D) turns off.
  - Connecting or disconnecting the AC adaptor
  - Pressing the power switch
  - Touching the keyboard, touchpad, touchscreen <only for model with touchscreen> or external mouse
  - Closing the display
  - Turn on/off the wireless switch
- When the CPU temperature is high, the computer may not start up to prevent overheating of the CPU. Wait until the computer cools down, and then turn the power on again. If the computer does not power on even after cooling down, contact Panasonic Technical Support (→ pages 42 - 53).
- Any changes from the default setting of the Setup Utility must not be made until the First-time Operation is completed.

## 5

### Windows 7

<For MUI OS model>

Select language and OS (32-bit or 64-bit)

### CAUTION

- Carefully choose your language because you cannot change it later. If you set a wrong language, you need to reinstall Windows.

- ① Select language and OS (32-bit or 64-bit) on “Select OS” screen and click [OK].  
The language setting will start by clicking [OK] on the confirmation screen.  
The language and OS setting will be completed in about 15 minutes.
- ② When termination screen is displayed, click [OK] to turn off the computer.

## 6 Setup Windows

### Windows 10

Select language and click [Next].

### Windows 7

Turn on the computer.



Follow the on-screen instructions.

- The computer restarts several times. Do not touch the keyboard, touchpad or touchscreen <only for model with touchscreen>, and wait until the drive indicator  has turned off.
- After the computer is turned on, the screen remains black or unchanged for a while, but this is not a malfunction. Wait for a moment until the Windows setup screen appears.
- During setup of Windows, use the touchpad and clicking to move the pointer and to click an item.
- Setup of Windows will take approximately **Windows 10** 5 minutes / **Windows 7** 20 minutes.  
Go to the next step, confirming each message on the display.
- You can set the Wireless Network after the setup of Windows is complete.  
**Windows 10** If “Let’s get connected” is displayed, select “Skip this step”.  
**Windows 7** “Join a wireless network” screen may not appear.
- **Windows 10** Verify the time zone, date and time.

#### CAUTION

- You can change the user name, password, image and security setting after setup of Windows.
  - Remember your password. If you forget the password, you cannot use Windows. Creating a password reset disk beforehand is recommended.
  - Do not use the following words and characters for user name: CON, PRN, AUX, CLOCK\$, NUL, COM1 to COM9, LPT1 to LPT9, LPT, &, space.
  - **Windows 7**  
In particular, if you create a user name (account name) that includes the “@” mark, a password will be requested at the log-on screen, even if no password has been set. If you try to log on without entering a password, “The user name or password is incorrect.” may be displayed and you will not be able to log on to Windows.
- <For MUI OS model>
- When setting up the keyboard, choose the appropriate one to your computer.  
Otherwise, input by the keyboard may become unavailable.

## 7 **Windows 10** Restart the computer

- ① Click  (Start).
  - ② Click  (Power) - [Restart].
- A portion of the Panasonic PC Settings Utility functions will be enabled after the computer restarts.



## 8 Update the on-screen manual

- ① Connect to the internet. **Windows 10** Sign in / **Windows 7** Log on to Windows as an administrator.  
For further information, refer to  *Connect to a network*.
- ② Update the on-screen manual.  
**Windows 10**  
Double-click the [Panasonic PC Settings Utility] on the desktop screen, and then click [Support] - [Manual] - [Launch Manual Selector].  
**Windows 7**  
Double-click [Manual Selector] on the desktop.  
Follow the on-screen instructions.



## 9 Create a recovery disc

A recovery disc allows you to install OS and restore its factory default condition, in case, the recovery partition of the HDD is damaged.  
We recommend creating a recovery disc before you begin using the computer.  
Refer to →  *Reference Manual* “Recovery Disc Creation Utility” about creating the disc.

### NOTE

- **Windows 10** **Panasonic PC Settings Utility**  
You can check the status of the computer, and change the settings. Double-click [Panasonic PC Settings Utility] on the desktop to start the utility.  
(→  *Reference Manual* “Panasonic PC Settings Utility”)
- **PC Information Viewer**  
This computer periodically records the management information of the hard disk, etc. The maximum data volume for each record is 1024 bytes.  
This information is only used for estimating the cause in the case when the hard disk goes down by any possibility. They are never sent to outside via network nor used for any other purpose except for the purpose described the above.  
To disable the function, add the check mark for [Disable the automatic save function for management information history] in [Hard Disk Status] of PC Information Viewer, and click [OK].  
Then follow the on-screen instructions.  
(→  *Reference Manual* “Troubleshooting (Advanced)” - “Checking the Computer’s Usage Status” <For MUI OS model>)
- If the recovery partition is deleted, you cannot create Recovery Disc(s).

### ■ Before using wireless function

- ① Open the cover, and then Slide the wireless switch to ON.  
**Windows 10**
- ② Click  (Notification) at the task tray, and then click  (All settings) - [Network & Internet] - [Airplane mode].  
Set [Airplane mode] to [Off], and then;  
Set [Wi-Fi] to [On] (for wireless LAN).  
Set [Cellular] to [On] (for wireless WAN).  
Set [GPS] to [On] (for wireless WAN).

Set [Bluetooth] to [On] (for Bluetooth).

Set [GPS\GNSS] to [On] (for GPS).

\* The displayed items will vary depending on specifications.

## ■ About the partition structure

You can shrink a part of an existing partition to create unallocated disk space, from which you can create a new partition.

In the default setting, you can use a single partition.

---

### CAUTION

#### Windows 10

- Do not add or delete partitions in Windows 10, as the Windows area and recovery partition must be adjacent to each other in Windows 10.

---

#### Windows 7 To change the partition structure

- ① Click  (Start) and right-click [Computer], then click [Manage].
  - A standard user needs to enter an administrator password.
- ② Click [Disk Management].
- ③ Right-click the partition for Windows (“c” drive in the default setting), and click [Shrink Volume].
  - The partition size depends on the computer specifications.
- ④ Input the size in [Enter the amount of space to shrink in MB] and click [Shrink].
  - You cannot input a larger number than the displayed size.
  - To select [Reinstall Windows to the OS related partitions] in installing OS (→ page 22), 65 GB or more is necessary for [Total size after shrink in MB].
- ⑤ Right-click [Unallocated] (the shrunk space in the step ④) and click [New Simple Volume].
- ⑥ Follow the on-screen instructions to make the settings, and click [Finish].  
Wait until formatting is completed.



---

### NOTE

- You can create an additional partition using remaining unallocated space or newly creating unallocated space.
- To delete a partition, right-click the partition and click [Delete Volume] in the step ③.

# Turning On / Turning Off

## Turning On



Press and hold the power switch  (→ page 4) until the power indicator  (→ page 4) lights.

### NOTE

- Do not press the power switch repeatedly.
- The computer will forcibly be turned off if you press and hold the power switch for four seconds or longer.
- Once you turn off the computer, wait for ten seconds or more before you turn on the computer again.
- Do not perform the following operation until the drive indicator  turns off.
  - Connecting or disconnecting the AC adaptor
  - Pressing the power switch
  - Touching the keyboard, touchpad, touchscreen <only for model with touchscreen> or external mouse
  - Closing the display
  - Turn on/off the wireless switch

## Turning Off

### Windows 10

- ① Click  (Start) at the lower left.
- ② Click  (Power) - [Shut down].

### Windows 7

- ① Click  (Start) - [Shut down].

### NOTE

- **Windows 10**  
To turn off the computer completely, proceed as follows.
  - ① Click  (Start) at the lower left, and the click  (Settings) - [Update & security] - [recovery].
  - ② Click [Restart now] under “Advanced startup”.
  - ③ Click [Turn off your PC].

## Precautions against Starting Up/Shutting Down

- Do not do the following
  - Connecting or disconnecting the AC adaptor
  - Pressing the power switch
  - Touching the keyboard, touchpad, touchscreen <only for model with touchscreen> or external mouse
  - Closing the display
  - Turn on/off the wireless switch

### NOTE

- To conserve power, the following power saving methods are set at the time of purchase.
  - The screen automatically turns off after :
    - 10 minutes (when AC adaptor is connected) of inactivity
    - 5 minutes (when operating on battery power) of inactivity
  - The computer automatically enters sleep<sup>\*1</sup> after :
    - 20 minutes (when AC adaptor is connected) of inactivity
    - 15 minutes (when operating on battery power) of inactivity

<sup>\*1</sup> Refer to  *Reference Manual* "Sleep or Hibernation Functions" about resuming from sleep.

# Handling and Maintenance

## Operation environment

- Place the computer on a flat stable surface not subject to shock, vibration, and danger of dropping. Do not place the computer upright or turn it over. If the computer is exposed to an extremely strong impact, it may become damaged.
  - Operating environment
    - Temperature: Operation : -10 °C to 50 °C {14 °F to 122 °F} (IEC60068-2-1, 2)<sup>\*1</sup>
    - Storage : -20 °C to 60 °C {-4 °F to 140 °F}
    - Humidity: Operation : 30% to 80% RH (No condensation)
    - Storage : 30% to 90% RH (No condensation)
- Even within the above temperature/humidity ranges, operation for a long time in extreme environments, smoking nearby, or operation in places where oil is used or where there is a lot of dust will result in the product deterioration and will shorten the product life.
- <sup>\*1</sup> Do not expose the skin to this product when using the product in a hot or cold environment.  
(→ OPERATING INSTRUCTIONS - Read Me First)
- If the computer is wet in temperatures of 0 °C {32 °F} or below, freeze damage may occur. Make sure to dry off the computer in such temperatures.
- Do not place the computer in the following areas, otherwise the computer may be damaged.
    - Near electronic equipment. Image distortion or noise may occur.
    - In extremely high or low temperature.
  - As the computer can become hot during operation, keep it away from items that are sensitive to heat.

## Handling cautions

This computer is designed to minimize shock to parts such as the LCD and the hard disk drive and equipped with a drip-proof keyboard, but no warranty is provided against any trouble caused by shock. Be extremely careful when handling the computer.

- When carrying the computer:
    - Turn off the computer.
    - Remove all external devices, cables, PC Cards and other protruding objects.
    - Remove a disc in the CD/DVD drive (Only for model with CD/DVD drive).
    - Do not drop or hit the computer against solid objects.
    - Do not leave the display open.
    - Do not grip the display part.
  - Do not put anything (e.g., a piece of paper) between the display and keyboard.
  - When you board an airplane, take the computer with you and never put it in your checked luggage. When using the computer on airplane, follow the airline's instructions.
  - When carrying a spare battery, put it in a plastic bag to protect its terminals.
  - The touchpad is designed to be used by finger tip. Do not place any object on its surface and do not press down strongly with sharp-pointed or hard objects that may leave marks (e.g., nails, pencils and ball point pens).
  - Avoid any harmful substances such as oil from getting into the touchpad. The pointer may not work correctly.
  - Be careful not to get injured by dropping or getting hit when carrying the computer.
- <Only for model with touchscreen>
- Use only the pen (optional) to touch the screen. Do not place any object on its surface and do not press down strongly with sharp-pointed or hard objects that may leave marks (e.g., nails, pencils and ball point pens).
  - Do not use the screen when dust or dirt (e.g., oil) is on the screen. Otherwise foreign particles on the screen/pen (optional) can scratch the screen surface or obstruct the pen (optional) operation.



- Use the pen (optional) only for touching the screen. Using it for any other purpose may damage the pen (optional) and result in scratches on the screen.

### ■ When using peripheral devices

Follow these instructions and the Reference Manual to avoid any damage to the devices. Carefully read the instruction manuals of the peripheral devices.

- Use the peripheral devices conforming to the computer's specifications.
- Connect to the connectors in the correct direction.
- If it is hard to insert, do not try forcibly but check the connector's shape, direction, alignment of pins, etc.
- If screws are included, fasten them securely.
- Remove the cables when you carry the computer. Do not pull the cables forcibly.

### ■ Preventing your computer from unauthorized use via wireless LAN/Bluetooth/wireless WAN

<Only for model with wireless LAN/Bluetooth/wireless WAN>

- Before using wireless LAN/Bluetooth/wireless WAN, make the appropriate security settings such as data encryption.

### ■ Battery Recalibration

- The battery recalibration may take a long time due to the large battery capacity. This is not a malfunction.

<When performing "Battery Recalibration" after shutting down Windows>

- Full charge: Approximately 2.5 hours
- Complete discharge: Approximately 4 hours (with CF-VZSU0PW / CF-VZSU0LW) / Approx. 3 hours (with CF-VZSU0KW)

When performing "Battery Recalibration" without shutting down Windows, it may take more time to charge / discharge.

### ■ Battery duration

- Note that the computer consumes electricity even when the computer power is off. If the battery pack is fully charged, the battery will fully discharge in the following period of time:

Status	Discharge period	
	CF-VZSU0PW	CF-VZSU0LW
When power is off	Approx. 5 weeks	Approx. 3.5 weeks
In sleep <sup>*2</sup>	Approx. 2.5 days	Approx. 2 days
In hibernation <sup>*2</sup>	Approx. 9 days	Approx. 6.5 days

<sup>\*2</sup> When "Wake Up from wired LAN" is enabled.

The battery duration while the USB port continuous charging function is not used.

## Maintenance

### To clean the LCD panel

If drops of water or other stains get on the surface of the LCD panel, wipe them off immediately. Failure to do so may result in staining.

<Only for model with touchscreen>

Use the soft cloth included with the computer. (For further information, refer to "Suggestions About Cleaning the LCD Surface". →  *Reference Manual* "Screen Input Operation")

<Only for model without touchscreen>

Wipe with a soft dry cloth such as gauze.

# Handling and Maintenance

## To clean areas other than the LCD panel

Wipe with a soft dry cloth such as gauze. When using detergent, dip a soft cloth in water-diluted detergent and wring it thoroughly.

### CAUTION

- Do not use benzene, thinner, or rubbing alcohol since it may adversely affect the surface causing discoloration, etc. Do not use commercially-available household cleaners and cosmetics, as they may contain components harmful to the surface.
- Do not apply water or detergent directly to the computer, since liquid may enter inside of the computer and cause malfunction or damage.
- Use a soft, dry cloth to wipe droplets of water from the surface of the unit. Do not use a microwave to dry the unit. Doing so will result in malfunction or damage.

## Dispose of Computer

### ■ Preparation

- Remove all peripherals and SD memory card, etc.
- Erase the stored data. (→  Reference Manual “Hard Disk Data Erase Utility”)

<Only for model with Built-in Bridge Battery>

<For Europe and U.S.A./Canada>

### Attention Customers

Don't remove the battery by yourself. The battery must be removed by qualified professionals. When disposing of this product, be sure to contact qualified professionals to remove the battery.

### Attention Qualified professionals to remove the battery

Dispose of this product correctly in accordance with the local regulations after removing the battery as shown in the following procedure.

### CAUTION

- Never disassemble the computer except before disposal.
- Refer to the precautions when disposing of the computer (→ *OPERATING INSTRUCTIONS - Read Me First*).

### ■ Remove the built-in battery

1. Turn off the computer, and disconnect the AC adaptor.
2. Turn over the computer, remove the battery pack.
3. Remove the screws and the cover (A).

<Model with 2nd LAN/  
USB 2.0 port/Rugged USB port/  
VGA port/Serial port/Discrete Video Controller>

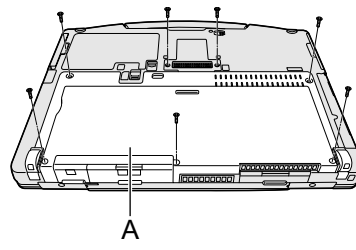
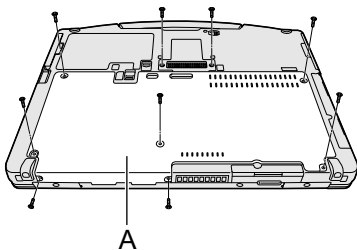

4. Remove the cover (B) and lift the expansion bus connector (C).

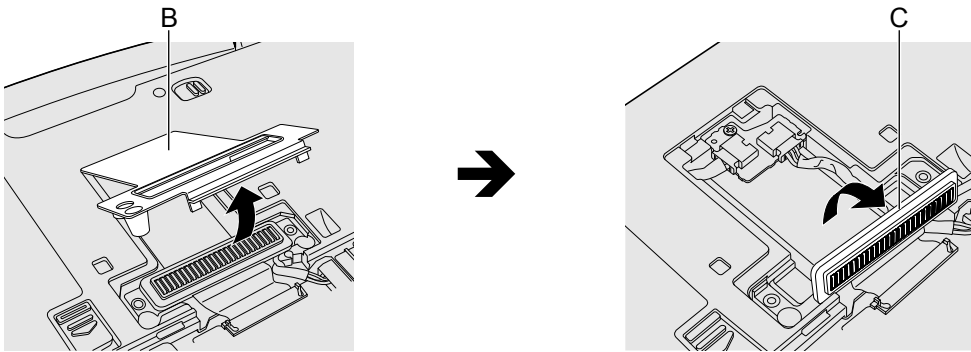

5. Remove the connectors on the built-in bridge battery (F), and then remove the screw (D) and the circuit (E).

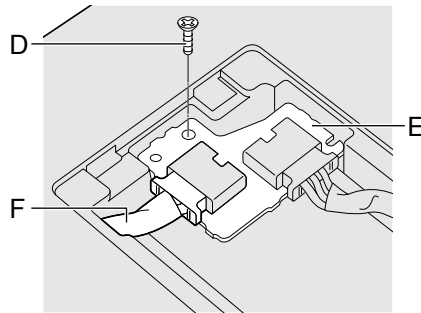

6. Pull out the built-in bridge battery with the sheet cover.

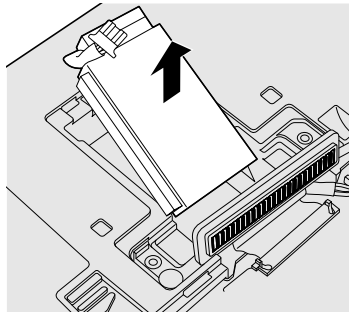

7. Open the sheet cover (G) and remove the built-in bridge battery (H). And confirm the recycle mark of the built-in battery.

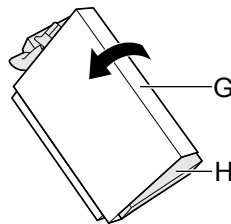

8. Insulate the connectors of the built-in bridge battery by covering them with plastic tape, for example.

# Installing Software

Installing software will return the computer to the default condition. When you install the software, the hard disk data will be erased.

Back up important data to other media or an external hard disk before installation.

## CAUTION

- Do not remove the quick release drive during installation process.
- Do not delete the Recovery Partition on the hard disk. The disk space in the partition is not available to store data.

To check the Recovery Partition, perform the following methods.

### ① Windows 10

Right-click  at the bottom left corner of the Desktop screen.

### Windows 7

Click  (Start) and right-click [Computer], then click [Manage].

- A standard user needs to enter an administrator password.

### ② Click [Disk Management].

## ■ Windows 10 Reset Windows

If the computer does not operate normally, or becomes unstable, you can reset Windows to solve the problem.

### Preparation

- Remove all peripherals and SD memory card, etc.
- Connect the AC adaptor and do not remove it until installation is complete.

## 1 Perform “Remove everything and reinstall Windows”.

① Click  (Start) - [Settings] - [Update & security] - [Recovery].

② Click [Get Started] under “Reset this PC”.

③ Click [Next].

④ Select the option.

1. [Keep my files]

Applications and other items that do not come with this computer will be removed.

2. [Remove everything]

- [Just remove my files]

- [Remove files and clean the drive]

By fully cleaning, the deleted files can not be recovered easily and the security level will be increased.

Follow the on-screen instructions. It may take several hours depending on the environment.

After the reinstallation, the computer will restart.

- Do not interrupt installation, for example by turning off the computer or performing other operation.

Otherwise installation may become unavailable as Windows may not start up or the data may be corrupted.

## 2 Perform the “Setup Windows” (→ page 10).

### NOTE

- The date and time, and the time zone may not be correct. Be sure to set them correctly.

## 3 Perform Windows Update.

## ■ Disk recovery

You can reinstall the OS that was pre-installed at the time of purchase (Windows 10 or Windows 7).

**Windows 10** If reinstallation using the method described in “Reset this PC” is not successful, follow the steps below.

### Preparation

- Remove all peripherals and SD memory card etc.
- Connect the AC adaptor and do not remove it until installation is complete.

## 1 Start the Setup Utility.

### Windows 10

- ① Click  (Start) - [Settings] - [Update & security] - [Recovery].
- ② Click [Restart now] under “Advanced startup”.
- ③ Click [Troubleshoot] - [Advanced options] - [UEFI Firmware Settings] - [Restart].

### Windows 7

Turn on the computer, and press **F2** or **Del** while [Panasonic] boot screen is displayed.

- If the [Panasonic] boot screen is not displayed, turn on the computer while holding down **F2** or **Del**.
- If the password is requested, enter the Supervisor Password.

## 2 Write down all of the contents of the Setup Utility and press **F9**.

At the confirmation message, select [Yes] and press **Enter**.

## 3 Check the [UEFI Boot] setting of the Setup Utility.

[UEFI Boot] should be set to as follows.

When installing Windows 10 : [Enabled]

When installing Windows 7 : [Disabled]

## 4 **Windows 7** <Only for model with onboard drive>

### Check the [Primary boot drive] setting of the Setup Utility.

## 5 Press **F10**.

At the confirmation message, select [Yes] and press **Enter**.

Computer will restart.

## 6 Press **F2** or **Del** while [Panasonic] boot screen is displayed.

The Setup Utility starts up.

- If the password is requested, enter the Supervisor Password.

## 7 Select the [Exit] menu, then select [Recovery Partition] and press **Enter**.

The procedure from step 8 and beyond differs between Windows 10 and Windows 7. For the procedure for Windows 7, skip to the "For Windows 7" section.

### For Windows 10

## 8 Click [Recovery]

Click [CANCEL] to abort the operation.

## 9 Click [Quick release drive: xxxxx].

# Installing Software

- 10 **Click [Recovery ALL Partitions].**  
**<Only for model with onboard drive>**  
**Select whether to format or retain the data on the onboard drive.**  
**Click [On board drive: Format] or [On board drive: Remain].**  
Follow the on-screen instructions. It may take several hours depending on the environment.
  - Do not interrupt installation, for example by turning off the computer or performing other operation.  
Otherwise installation may become unavailable as Windows may not start up or the data may be corrupted.
- 11 **When Ending process screen is displayed, click [Shutdown].**
- 12 **Turn on the computer.**
  - If the password is requested, enter the Supervisor Password.
- 13 **Perform the “Setup Windows” (→ page 10).**

## NOTE

- The date and time, and the time zone may not be correct. Be sure to set them correctly.

- 14 **Start the Setup Utility and change the settings as necessary.**

## For Windows 7

- 8 **Click [Reinstall Windows] and click [Next].**
- 9 **At the License Agreement screen, click [Yes, I agree to the provisions above and wish to continue!] and click [Next].**
- 10 **Click [Next].**  
If the installation drive is displayed, confirm it.  
If the option is displayed, select the setting and click [Next].
  - [Initialize and reinstall Windows to the whole Disk]  
Select this option when you want to install Windows to the factory default. After installation, you can create a new partition. For how to create a new partition, refer to “To change the partition structure” (→ page 13)
  - [Reinstall Windows to the OS related partitions]<sup>\*1</sup>  
Select this option when the hard disk has already been divided into several partitions and you want to keep the partition structure. For how to create a new partition, refer to “To change the partition structure” (→ page 13).  
\*1 This does not appear if Windows cannot be installed to the recovery partition and the area usable by Windows.
- 11 **At the confirmation message, click [YES].**
- 12 **<For localized OS model>**  
**Select OS (32bit or 64bit) and click [OK].**  
**<For MUI OS model>**  
**Select language and system type (32bit or 64bit), then click [OK].**  
To cancel the recovery procedure, click [CANCEL], and click the  mark that appears at the top right corner of the screen.
- 13 **<Only for model with onboard drive>**  
**Select the setting and click [Next].**

**14 At the confirmation message, click [YES].**

Follow the on-screen instructions. It may take several hours depending on the environment.

- Do not interrupt installation, for example by turning off the computer or performing other operation.

Otherwise installation may become unavailable as Windows may not start up or the data may be corrupted.

**15 When Ending process screen is displayed, click [OK] to turn off the computer.**

**16 Turn on the computer.**

- If the password is requested, enter the Supervisor Password.

**17 Perform the “Setup Windows” (→ page 10).**

**18 Start the Setup Utility and change the settings as necessary.**

**■ Using Recovery Disc**

Use the Recovery Disc in the following conditions.

- You have forgotten the administrator password.
- Installation is not complete. The recovery partition in the hard disk may be broken.
- **Windows 7** <Only for Windows 7 downgrade model>

To change OS from Windows 7 to Windows 10, or vice versa.

**NOTE**

- **Windows 7** To change OS from 32 bit to 64 bit, or vice versa, install OS using the recovery partition in the hard disk.

**Preparation**

- Prepare the following items:
  - Recovery Disc ( **Windows 10** USB memory device can also be used as a recovery disc.) ( →  *Reference Manual* “Recovery Disc Creation Utility”)
  - Commercially available optical drive (Only for model without CD/DVD drive)
- Remove all peripherals and SD memory card etc. (except for the commercially available optical drive).
- Connect the AC adaptor and do not remove it until installation is complete.

**1 <Only for model without CD/DVD drive>**

**Connect the commercially available optical drive to the USB port.**

**2 Start the Setup Utility.**

**Windows 10**

- ① Click  (Start) - [Settings] - [Update & security] - [Recovery].
- ② Click [Restart now] under “Advanced startup”.
- ③ Click [Troubleshoot] - [Advanced options] - [UEFI Firmware Settings] - [Restart].

**Windows 7**

Turn on the computer, and press **F2** or **Del** while [Panasonic] boot screen is displayed.

- If the [Panasonic] boot screen is not displayed, turn on the computer while holding down **F2** or **Del**.
- If the password is requested, enter the Supervisor Password.

**3 Write down all of the contents of the Setup Utility and press **F9**.**

At the confirmation message, select [Yes] and press **Enter**.

# Installing Software

- 4 **Check the [UEFI Boot] setting of the Setup Utility.**  
[UEFI Boot] should be set to as follows.  
When the recovery disc for Windows 10 is used : [Enabled]  
When the recovery disc for Windows 7 is used : [Disabled]
- 5 **Set the Recovery Disc into the CD/DVD drive or commercially available optical drive.**
- 6 **Press F10.**  
At the confirmation message, select [Yes] and press Enter.  
Computer will restart.
- 7 **Press F2 or Del while [Panasonic] boot screen is displayed.**  
The Setup Utility starts up.
  - If the password is requested, enter the Supervisor Password.
- 8 **Windows 10**  
**Select the [Exit] menu, then select CD/DVD drive or commercially available optical drive and press Enter.**  
**Windows 7**  
**Select the [Exit] menu, then select CD/DVD drive or commercially available optical drive in [Boot Override] and press Enter.**  
The computer will restart.

The procedure from step 9 and beyond differs between Windows 10 and Windows 7. For the procedure for Windows 7, skip to the “For Windows 7” section.

## For Windows 10

- 9 **Click [Recovery].**
- 10 **Confirm the contents of “EULA”, and click [Accept.] if you continue.**
- 11 **Select the OS install destination.**  
**Select [Quick release drive: xxxxx]**  
**<Only for model with onboard drive>**  
**Select [Quick release drive: xxxxx] or [On board drive: xxxx].**
- 12 **Click [Recovery ALL Partitions.].**  
**<Only for model with onboard drive>**  
**Select [On board drive: Format] or [On board drive: Remain].**
- 13 **Select the configuration of the OS install destination.**  
**Select [Remain recovery partitions] or [Remove recovery partitions].**  
Follow the on-screen instructions. It may take several tens of minutes depending on the environment.
  - Do not interrupt installation, for example by turning off the computer or performing other operation.Otherwise installation may become unavailable as Windows may not start up or the data may be corrupted.
- 14 **When Ending process screen is displayed, remove the Recovery Disc and CD/DVD drive or commercially available optical drive and then click [Reboot]**  
Follow the on-screen instructions.



- 15 On the “Finish Recovery Process.” screen, click [Shutdown].
- 16 Turn on the computer.
  - If the password is requested, enter the Supervisor Password.
- 17 Perform the “Setup Windows” (→ page 10).
- 18 Start the Setup Utility and change the settings as necessary.

### For Windows 7

- 9 Click [Reinstall Windows] and click [Next].
- 10 At the License Agreement screen, click [Yes, I agree to the provisions above and wish to continue!] and click [Next].
- 11 <For MUI OS model>  
Click [Next].

If the option is displayed, select the setting and click [Next].

- [Remain recovery partition.]  
Standard recovery method.  
You can use recovery from Recovery Partition.
- [Remove recovery partition.]  
Increase usable HDD size.  
You can NOT use recovery from Recovery Partition.  
When this option is selected, you can no longer create Recovery Disc(s) after the recovery operation.

#### CAUTION

- Carefully choose above item because you cannot change it later.

- 12 Click [Next].  
<Only for model with onboard drive>  
If the installation drive is displayed, confirm it.  
If the option is displayed, select the setting and click [Next].
  - [Initialize and reinstall Windows to the whole Disk]  
Select this option when you want to install Windows to the factory default. After installation, you can create a new partition. For how to create a new partition, refer to “To change the partition structure” (→ page 13).
  - [Reinstall Windows to the OS related partitions]<sup>2</sup>  
Select this option when the hard disk has already been divided into several partitions and you want to keep the partition structure. For how to create a new partition, refer to “To change the partition structure” (→ page 13).  
<sup>2</sup> This does not appear if Windows cannot be installed to the recovery partition and the area usable by Windows.
- 13 <Only for model with onboard drive>  
Select the setting and click [Next].
- 14 At the confirmation message, click [YES].
- 15 <For MUI OS model>  
Select language and system type (32bit or 64bit), then click [OK].  
To cancel the recovery procedure, click [CANCEL], and click the  mark that appears at the top right corner of the screen.

# Installing Software

**16 At the confirmation message, click [YES].**

Follow the on-screen instructions. It may take several tens of minutes depending on the environment.

- Do not interrupt installation, for example by turning off the computer or pressing **Ctrl + Alt + Del**.

Otherwise installation may become unavailable as Windows may not start up or the data may be corrupted.

**17 When Ending process screen is displayed, remove the Recovery Disc and CD/DVD drive or commercially available optical drive and then click [OK].**

Follow the on-screen instructions.

Some models may take approximately 40 minutes.

**18 Turn on the computer.**

- If the password is requested, enter the Supervisor Password.

**19 Perform the “Setup Windows” (→ page 10).**

**20 Start the Setup Utility and change the settings as necessary.**

# Troubleshooting (Basic)



Follow the instructions below when a problem has occurred. There is also an advanced troubleshooting guide in the “Reference Manual”. For a software problem, refer to the software’s instruction manual. If the problem persists, contact Panasonic Technical Support (→ pages 42 - 53). You can also check the computer’s status in the PC Information Viewer (→  Reference Manual “Troubleshooting (Advanced)”).

## ■ Starting Up







<p>Cannot start up. The power indicator or battery indicator is not lit.</p>	<ul style="list-style-type: none"> <li>● Connect the AC adaptor.</li> <li>● Insert a fully charged battery.</li> <li>● Remove the battery pack and the AC adaptor, then connect them again.</li> <li>● Even if the AC adaptor and battery pack are correctly connected, if the battery indicator is not lit, the AC adaptor protection function may be operating. Disconnect the AC cord, wait three minutes or more, and reconnect the AC cord.</li> <li>● If a device is connected to the USB port, disconnect the device, or set [USB Port] or [Legacy USB Support] to [Disabled] in the [Advanced] menu of the Setup Utility.</li> <li>● Press <b>Fn</b> + <b>F8</b> to turn off the concealed mode.</li> <li>● Check the [UEFI Boot] setting of the Setup Utility. [UEFI Boot] should be set to <b>Windows 10</b> [Enabled] / <b>Windows 7</b> [Disabled].</li> <li>● <b>Windows 7</b> &lt;Only for model with onboard drive&gt; Check the [Primary boot drive] setting of the Setup Utility.</li> </ul>
<p>The power is turned on but “Warming up the system (up to 30 minutes)” appears.</p>	<ul style="list-style-type: none"> <li>● The computer is warming up before start up. Wait for the computer to start up (takes up to 30 minutes). If, “Cannot warm up the system” is displayed, the computer failed to warm up and does not start. In this case, turn off the computer, leave it in an environment of 5 °C {41 °F} or higher temperature for about an hour, and then turn on the power once more.</li> </ul>
<p>Cannot turn on the computer. The computer does not resume from sleep. (The power indicator blinks rapidly in green.)</p>	<ul style="list-style-type: none"> <li>● Leave it in an environment of 5 °C {41 °F} or higher temperature for about an hour, then turn on the power again.</li> </ul>
<p>After adding or changing the RAM module, the power is turned on but nothing is displayed on the screen.</p>	<ul style="list-style-type: none"> <li>● Turn off the computer and remove the RAM module, then confirm whether the RAM module has compliant to specification. When the RAM module has conformed to specification, install it again.</li> </ul>
<p>The computer does not enter sleep mode while the screen saver is running. (The screen stays black.)</p>	<ul style="list-style-type: none"> <li>● Press and hold the power switch for 4 seconds or longer to shut down the computer forcibly. (Data not saved will be lost.) Then disable the screen saver.</li> </ul>
<p>It takes time for the power indicator to light up.</p>	<ul style="list-style-type: none"> <li>● If the power switch is pressed immediately after the battery pack has been mounted on the computer, and while the AC adaptor is not connected, it may take about five seconds before the power indicator lights up and the computer turns on. This is because the computer is checking the remaining battery charge; it is not a malfunction.</li> </ul>

# Troubleshooting (Basic)

## ■ Starting Up

<p>You have forgotten the password.</p>	<ul style="list-style-type: none"> <li>● Supervisor Password or User Password: Contact Panasonic Technical Support (→ pages 42 - 53).</li> <li>● Administrator password:             <ul style="list-style-type: none"> <li>• If you have a password reset disk, you can reset the administrator password. Set the disk and enter any wrong password, then follow the on-screen instructions and set a new password.</li> <li>• If you do not have a password reset disk, install (→ page 20) and set up Windows, and then set a new password.</li> </ul> </li> </ul>
<p>“Remove disks or other media. Press any key to restart” or a similar message appears.</p>	<ul style="list-style-type: none"> <li>● If a device is connected to the USB port, disconnect the device, or set [USB Port] or [Legacy USB Support] to [Disabled] in the [Advanced] menu of the Setup Utility.</li> <li>● If the problem persists after removing the disk, it may be a hard disk failure. Contact Panasonic Technical Support (→ pages 42 - 53).</li> <li>● Set [UEFI Boot] to [Disabled] in the [Boot] menu of the Setup Utility.</li> </ul>
<p>Windows startup and operation is slow.</p>	<ul style="list-style-type: none"> <li>● Press <b>F9</b> in the Setup Utility (→  <i>Reference Manual</i> “Setup Utility”) to return the Setup Utility settings (excluding the passwords) to the default values. Start the Setup Utility and make the settings again. (Note that the processing speed depends on the application software, so this procedure may not make Windows faster.)</li> <li>● If you installed a resident software after purchase, turn off the residence.</li> </ul>
<p>The date and time are incorrect.</p>	<ul style="list-style-type: none"> <li>● Make the correct settings.             <ol style="list-style-type: none"> <li>① Open the Control Panel.                 <ul style="list-style-type: none"> <li><b>Windows 10</b> Right-click  (Start) at the bottom left corner, and then click [Control Panel].</li> <li><b>Windows 7</b> Click  (Start) - [Control Panel].</li> </ul> </li> <li>② Click [Clock, Language, and Region] - [Date and Time].</li> </ol> </li> <li>● If the problem persists, the internal clock battery may need to be replaced. Contact Panasonic Technical Support (→ pages 42 - 53).</li> <li>● When the computer is connected to LAN, check the date and time of the server.</li> <li>● The 2100 A.D. or later year will not be correctly recognized on this computer.</li> </ul>
<p>[Executing Battery Recalibration] screen appears.</p>	<ul style="list-style-type: none"> <li>● The Battery Recalibration was cancelled before Windows was shut down last time. To start up Windows, turn off the computer by the power switch, and then turn on.</li> </ul>

## ■ Starting Up

<p>[Enter Password] does not appear when resuming from sleep/hibernation.</p>	<ul style="list-style-type: none"> <li>● Select [Enabled] in [Password On Resume] in the [Security] menu of the Setup Utility (→  <i>Reference Manual</i> “Setup Utility”).</li> <li>● The Windows password can be used instead of the password set in the Setup Utility.             <ol style="list-style-type: none"> <li>① Add a password.                 <ul style="list-style-type: none"> <li><b>Windows 10</b></li> <li>1. Click  (Start) - [Settings] - [Accounts].</li> <li>2. Click [Sign-in options], and click [Add] under “Password”.</li> <li><b>Windows 7</b></li> <li>1. Click  (Start) - [Control Panel].</li> <li>2. Click [User Accounts and Family Safety] - [Add or remove user accounts].</li> </ul> </li> <li>② Set up the following.                 <ul style="list-style-type: none"> <li><b>Windows 10</b></li> <li>1. Open the Control Panel, click [System and Security] - [Power Options] - [Require a password on wakeup].</li> <li>2. Add a check mark for [Require a password].</li> <li><b>Windows 7</b></li> <li>1. Click [Control Panel] - [System and Security] - [Power Option] - [Require a password when the computer wakes] and add a check mark for [Require a password].</li> </ul> </li> </ol> </li> </ul>
<p>Cannot resume.</p>	<ul style="list-style-type: none"> <li>● One of the following operations may have been carried out. Press the power switch turn on the computer. Data not saved will be lost.             <ul style="list-style-type: none"> <li>• In sleep mode, the AC adaptor or battery pack was disconnected, or a peripheral was connected or disconnected.</li> <li>• The power switch was slid for four seconds or longer to forcibly turn off the computer.</li> </ul> </li> <li>● An error may occur when the computer automatically enters the sleep or hibernation mode while the screensaver is active. In this case, turn off the screensaver or change the pattern of the screensaver.</li> </ul>
<p>Other startup problems.</p>	<ul style="list-style-type: none"> <li>● Start in the Setup Utility (→  <i>Reference Manual</i> “Setup Utility”) to return the Setup Utility settings (excluding the passwords) to the default values. Start the Setup Utility and make the settings again.</li> <li>● Remove all peripheral devices.</li> <li>● Check to see if there was a disk error.             <ol style="list-style-type: none"> <li>① Remove all peripheral devices including an external display.</li> <li>② <b>Windows 10</b> Right-click  (Start) at the bottom left corner, and then click [File Explorer].</li> <li><b>Windows 7</b> Click  (Start) - [Computer].</li> <li>③ Right-click [This PC].</li> <li>④ Right-click <b>Windows 10</b> [Windows (C:)] / <b>Windows 7</b> [Local Disk (C:)], and click [Properties].</li> <li>⑤ Click [Tools] - <b>Windows 10</b> [Check] / <b>Windows 7</b> [Check Now...].                 <ul style="list-style-type: none"> <li>• A standard user needs to enter an administrator password.</li> </ul> </li> <li>⑥ Follow the on-screen instructions.</li> </ol> </li> </ul>

# Troubleshooting (Basic)

## ■ Entering Password

Even after entering the password, password input screen is displayed again.	<ul style="list-style-type: none"> <li>● The computer may be in ten-key mode. If the NumLk indicator (⌵) lights, press <b>NumLk</b> to disable the ten-key mode, and then input.</li> <li>● The computer may be in Caps Lock mode. If the Caps Lock indicator (⌵) lights, press <b>Caps Lock</b> to disable the Caps Lock mode, and then input.</li> </ul>
---	--

## ■ Shutting down

Windows does not shut down.	<ul style="list-style-type: none"> <li>● Remove the USB device.</li> <li>● Wait 1 or 2 minutes. It is not a malfunction.</li> </ul>
-----------------------------	---

## ■ Display

No display.	<ul style="list-style-type: none"> <li>● The external display is selected. Press <b>Fn + F3</b> or <b>⊞ + P</b> to switch the display. <b>Windows 10</b> Then click the display mode. <b>Windows 7</b> Wait until the display has been switched completely before pressing <b>Fn + F3</b> or <b>⊞ + P</b> again.</li> <li>● When using an external display,             <ul style="list-style-type: none"> <li>• Check the cable connection.</li> <li>• Turn on the display.</li> <li>• Check the settings of external display.</li> </ul> </li> <li>● The display is turned off by the power-saving function. The screen returns to the original state when you operate keyboard, touchpad, or touchscreen (only for model with touchscreen). When operating the keyboard, press a key that does not affect the computer operation, such as <b>Ctrl</b>.</li> <li>● The computer entered sleep or hibernation by the power-saving function. To resume, press the power switch.</li> </ul>
The screen is dark.	<ul style="list-style-type: none"> <li>● The screen is darker when the AC adaptor is not connected. Press <b>Fn + F2</b> and adjust the brightness. As you increase the brightness, battery consumption increases. You can separately set the brightness for when the AC adaptor is connected and when not connected.</li> <li>● Press <b>Fn + F8</b> to turn off the concealed mode.</li> <li>● Under factory default settings, the brightness of the display screen will adjust automatically based on the ambient light detected by the ambient light sensor. You can adjust the settings for this sensor.</li> </ul>
The screen is disordered.	<ul style="list-style-type: none"> <li>● Changing the number of display colors and resolution may affect the screen. Restart the computer.</li> <li>● Connecting/disconnecting an external display may affect the screen. Restart the computer.</li> <li>● Resuming from sleep or hibernation may affect the screen of the external display. Restart the computer.</li> </ul>

## ■ Display

During Simultaneous display, one of the screens becomes disordered.	<ul style="list-style-type: none"> <li>● When using the Extended Desktop, use the same display colors for the external display as those used by the LCD. If you continue to experience problems, try changing the display.</li> <li>● Simultaneous display cannot be used until Windows startup is complete (during Setup Utility, etc.).</li> </ul>
The external display does not work normally.	<ul style="list-style-type: none"> <li>● If the external display does not support the power saving function, it may not work normally when the computer enters the power saving mode. Turn off the external display.</li> </ul>

## ■ Touchpad

The pointer does not work.	<ul style="list-style-type: none"> <li>● When using the external mouse, connect it correctly.</li> <li>● Restart the computer using the keyboard.</li> <li>● If the computer does not respond to keyboard commands, read “No response” (→ page 32).</li> </ul>
Cannot input using the touchpad.	<ul style="list-style-type: none"> <li>● Set [Touch Pad] to [Enabled] in the [Main] menu of the Setup Utility.</li> <li>● The drivers for some mice may disable the touchpad. Check your mouse’s operating instructions.</li> </ul>

## ■ On-screen Document

<p><b>Windows 7</b></p> <p>The document of PDF format is not displayed.</p>	<ul style="list-style-type: none"> <li>● Install Adobe Reader.             <ol style="list-style-type: none"> <li>① Log on to Windows as an administrator.</li> <li>② Click  (Start) and input “c:\util\reader\en\Pinstall.bat” in [Search programs and files] then press <b>Enter</b>.</li> <li>③ Update Adobe Reader to its latest version. If your computer is connected to the internet, start up Adobe Reader and click [Help] - [Check for Updates...].</li> </ol> </li> </ul>
---	---

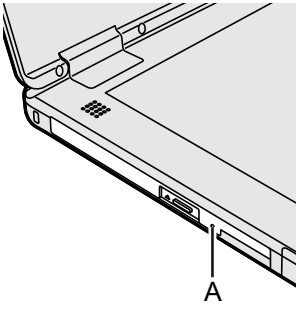

## ■ CD/DVD Drive (Only for model with CD/DVD drive)

The tray does not come out although inserting a pointed object to the emergency hole.	<ul style="list-style-type: none"> <li>● A pin of 1.3 mm in diameter is recommended to remove a disc using the emergency hole (A). When the diameter of the pin is smaller than this, insert the pin slightly downward.</li> </ul>	
---	--	--

# Troubleshooting (Basic)

## ■ Others

No response.

- Press **Ctrl+Shift+Esc** to open Task Manager and close the software application that is not responding.
- An input screen (e.g., password input screen at startup) may be hidden behind another window. Press **Alt+Tab** to check.
- Press the power switch for 4 seconds or longer to shut down the computer, and then press the power switch to turn it on. If the application program does not work normally, uninstall and reinstall the program. To uninstall,
  - ① **Windows 10**  
Right-click  (Start) at the bottom left corner, and then click [Control Panel].  
**Windows 7**  
Click  (Start) - [Control Panel].
  - ② Click [Program] - [Uninstall a program].



# LIMITED USE LICENSE AGREEMENT

THE SOFTWARE PROGRAM(S) (“PROGRAMS”) FURNISHED WITH THIS PANASONIC PRODUCT (“PRODUCT”) ARE LICENSED ONLY TO THE END-USER (“YOU”), AND MAY BE USED BY YOU ONLY IN ACCORDANCE WITH THE LICENSE TERMS DESCRIBED BELOW. YOUR USE OF THE PROGRAMS SHALL BE CONCLUSIVELY DEEMED TO CONSTITUTE YOUR ACCEPTANCE OF THE TERMS OF THIS LICENSE.

Panasonic Corporation has developed or otherwise obtained the Programs and hereby licenses their use to you. You assume sole responsibility for the selection of the Product (including the associated Programs) to achieve your intended results, and for the installation, use and results obtained therefrom.

## LICENSE

- A. Panasonic Corporation hereby grants you a personal, non-transferable and non-exclusive right and license to use the Programs in accordance with the terms and conditions stated in this Agreement. You acknowledge that you are receiving only a LIMITED LICENSE TO USE the Programs and related documentation and that you shall obtain no title, ownership nor any other rights in or to the Programs and related documentation nor in or to the algorithms, concepts, designs and ideas represented by or incorporated in the Programs and related documentation, all of which title, ownership and rights shall remain with Panasonic Corporation or its suppliers.
- B. You may use the Programs only on the single Product which was accompanied by the Programs.
- C. You and your employees and agents are required to protect the confidentiality of the Programs. You may not distribute or otherwise make the Programs or related documentation available to any third party, by time-sharing or otherwise, without the prior written consent of Panasonic Corporation.
- D. You may not copy or reproduce, or permit to be copied or reproduced, the Programs or related documentation for any purpose, except that you may make one (1) copy of the Programs for backup purposes only in support of your use of the Programs on the single Product which was accompanied by the Programs. You shall not modify, or attempt to modify, the Programs.
- E. You may transfer the Programs and license them to another party only in connection with your transfer of the single Product which was accompanied by the Programs to such other party. At the time of such a transfer, you must also transfer all copies, whether in printed or machine readable form, of every Program, and the related documentation, to the same party or destroy any such copies not so transferred.
- F. You may not remove any copyright, trademark or other notice or product identification from the Programs and you must reproduce and include any such notice or product identification on any copy of any Program.
- G. In order to provide important customer support services for the Product (including any associated Programs), Programs may collect certain non-personally identifiable information from you regarding your Product. Such information does not identify you as an individual and may include, but is not limited to, model numbers, serial numbers and battery serial numbers. The Programs may send such information to servers of Panasonic Corporation. Panasonic Corporation does not use such information for any purpose other than for providing customer support services.

YOU MAY NOT REVERSE ASSEMBLE, REVERSE COMPILE, OR MECHANICALLY OR ELECTRONICALLY TRACE THE PROGRAMS, OR ANY COPY THEREOF, IN WHOLE OR IN PART.

# LIMITED USE LICENSE AGREEMENT

YOU MAY NOT USE, COPY, MODIFY, ALTER, OR TRANSFER THE PROGRAMS OR ANY COPY THEREOF, IN WHOLE OR IN PART, EXCEPT AS EXPRESSLY PROVIDED IN THE LICENSE.

IF YOU TRANSFER POSSESSION OF ANY COPY OF ANY PROGRAM TO ANOTHER PARTY, EXCEPT AS PERMITTED IN PARAGRAPH E ABOVE, YOUR LICENSE IS AUTOMATICALLY TERMINATED.

## TERM

This license is effective only for so long as you own or lease the Product, unless earlier terminated. You may terminate this license at any time by destroying, at your expense, the Programs and related documentation together with all copies thereof in any form. This license will also terminate effective immediately upon occurrence of the conditions thereof set forth elsewhere in this Agreement, or if you fail to comply with any term or condition contained herein. Upon any such termination, you agree to destroy, at your expense, the Programs and related documentation together with all copies thereof in any form.

YOU ACKNOWLEDGE THAT YOU HAVE READ THIS AGREEMENT, UNDERSTAND IT AND AGREE TO BE BOUND BY ITS TERMS AND CONDITIONS. YOU FURTHER AGREE THAT IT IS THE COMPLETE AND EXCLUSIVE STATEMENT OF THE AGREEMENT BETWEEN US, WHICH SUPERSEDES ANY PROPOSAL OR PRIOR AGREEMENT, ORAL OR WRITTEN, AND ANY OTHER COMMUNICATIONS BETWEEN US, RELATING TO THE SUBJECT MATTER OF THIS AGREEMENT.

This product incorporates the following software:

- (1) the software developed independently by or for Panasonic Corporation,
- (2) the software owned by third party and licensed to Panasonic Corporation,
- (3) the software licensed under the GNU General Public License Version 2.0 (GPL V2.0),
- (4) the software licensed under the GNU LESSER General Public License, Version 2.1 (LGPL V2.1), and/or

(5) open source software other than the software licensed under the GPL V2.0 and/or LGPL V2.1. The software categorized as (3) - (5) are distributed in the hope that it will be useful, but WITHOUT ANY WARRANTY, without even the implied warranty of MERCHANTABILITY or FITNESS FOR A PARTICULAR PURPOSE. Please refer to the detailed terms and conditions thereof shown in the "Reference Manual".

At least three (3) years from delivery of this product, Panasonic will give to any third party who contacts us at the contact information provided below, for a charge no more than our cost of physically performing source code distribution, a complete machine-readable copy of the corresponding source code covered under GPL V2.0, LGPL V2.1 or the other licenses with the obligation to do so, as well as the respective copyright notice thereof.

Contact Information: [oss-cd-request@gg.jp.panasonic.com](mailto:oss-cd-request@gg.jp.panasonic.com)

The source code and the copyright notice are also available for free in our website below.

<http://panasonic.net/avc/oss/index.html>

## GOVERNMENT RESTRICTED RIGHTS.

The Software is provided with "RESTRICTED RIGHTS." Use duplication or disclosure by the government is subject to restrictions as set forth in FAR52.227-14 and DFAR252. 227-7013 et seq. or their successors.

Use of the Software by the government constitutes acknowledgement of Intel's proprietary rights therein.

Contractor or Manufacturer is Intel Corporation, 2200 Mission College Blvd., Santa Clara, CA 95052.

# Contrat de licence d'usage limité

Le(s) logiciel(s) (les "Logiciels") fournis avec ce produit Panasonic (le "Produit") sont exclusivement concédés en licence à l'utilisateur ultime ("vous"), et ils ne peuvent être utilisés que conformément aux clauses contractuelles cidessous. En utilisant les logiciels, vous vous engagez de manière définitive à respecter les termes, clauses et conditions des présentes.

Panasonic Corporation a mis au point ou obtenu les Logiciels et vous en concède l'utilisation par les présentes. Vous assumez l'entière responsabilité du choix de ce Produit (y compris des Logiciels associés) pour obtenir les résultats escomptés, ainsi que de l'installation, de l'utilisation et des résultats obtenus.

## Licence

- A. Panasonic Corporation vous octroie par les présentes le droit et la licence personnels, non cessibles et non exclusifs d'utiliser les Logiciels conformément aux termes, clauses et conditions de ce contrat. Vous reconnaissez ne recevoir qu'un droit limité d'utiliser les Logiciels et la documentation les accompagnant et vous vous engagez à n'obtenir aucun droit de titre, propriété ni aucun autre droit vis-à-vis des Logiciels et de la documentation les accompagnant ni vis-à-vis des algorithmes, concepts, dessins, configurations et idées représentés par ou incorporés dans les Logiciels et la documentation les accompagnant, dont les titres, propriété et droits resteront tous à Panasonic Corporation ou à leurs propriétaires.
- B. Vous ne pouvez utiliser les Logiciels que sur le Produit unique qui est accompagné par les Logiciels.
- C. Vous et vos employés ou agents êtes requis de protéger la confidentialité des Logiciels. Vous ne pouvez ni distribuer ni mettre les Logiciels et la documentation les accompagnant à la disposition d'un tiers, par partage de temps ou de quelque autre manière que ce soit, sans l'autorisation écrite préalable de Panasonic Corporation.
- D. Vous ne pouvez ni copier ni reproduire ni permettre la copie ni la reproduction des Logiciels ni de la documentation les accompagnant pour quelque fin que ce soit, à l'exception d'une (1) copie des Logiciels à des fins de sauvegarde uniquement pour soutenir votre utilisation des Logiciels sur le Produit unique qui est accompagné par les Logiciels. Vous ne pouvez ni modifier ni tenter de modifier les Logiciels.
- E. Vous ne pouvez céder les Logiciels et en octroyer la licence à une autre partie qu'en rapport avec votre cession du Produit unique qui est accompagné par les Logiciels à cette autre partie. Au moment de cette cession, vous devez céder également toutes les copies, que ce soit sous forme imprimée ou lisible par la machine, de tous les Logiciels ainsi que de la documentation les accompagnant, à la même partie ou détruire les copies non cédées.
- F. Vous ne pouvez retirer aucune marque de droits d'auteur, marque de commerce ou autre ni aucune identification de produit des Logiciels et vous devez reproduire et inclure toutes ces notices ou identifications de produit sur toutes les copies des Logiciels.
- G. Dans le but de fournir un service clientèle optimal pour l'appareil (y compris les programmes associés), les programmes peuvent collecter certains renseignements généraux concernant votre utilisation du produit. Ces informations ne peuvent pas vous identifier en tant qu'individu et peuvent notamment inclure les références, les numéros de série, et les numéros de série de la batterie du modèle. Les programmes peuvent envoyer ces informations aux serveurs de Panasonic Corporation. Panasonic Corporation n'utilisera pas ces informations dans un autre but que celui d'assurer le service clientèle.

Vous ne pouvez assembler en sens inverse, compiler en sens inverse ni retracer les Logiciels ni aucune de leurs copies, de façon électronique ou mécanique, en tout ou en partie.

# Contrat de licence d'usage limité

Vous ne pouvez utiliser, copier, modifier, altérer ni céder les Logiciels ni aucune de leurs copies, en tout ou en partie, à l'exception de ce qui est expressément stipulé dans ce contrat.

Si vous cédez la possession de toute copie ou de tout Logiciel à une autre partie, à l'exception de ce qui est autorisé au paragraphe E ci-dessus, votre licence est automatiquement résiliée.

## Termes, clauses et conditions

Cette licence n'est effective que pour la durée de possession ou de crédit-bail du Produit, à moins d'une résiliation antérieure. Vous pouvez résilier cette licence à tout moment en détruisant, à vos frais, les Logiciels et la documentation les accompagnant avec toutes leurs copies, sous quelque forme que ce soit. Cette licence sera également résiliée, avec application immédiate, si les conditions de résiliation définies ailleurs dans ce contrat se sont réalisées ou si vous ne respectez pas les termes, clauses et conditions qui y sont contenues. Au moment de la résiliation, vous acceptez de détruire, à vos frais, les Logiciels et la documentation les accompagnant avec toutes leurs copies, sous quelque forme que ce soit.

Vous reconnaissez avoir lu ce contrat, en avoir compris toute la substance et avoir accepté de respecter ses termes, clauses et conditions. Vous reconnaissez en outre qu'ils sont la description complète et exclusive du contrat conclu entre nous, contrat qui remplace et annule toute proposition ou contrat précédent, écrit ou oral, et toute autre communication entre nous, relativement à l'objet du présent contrat.

Ce produit contient le logiciel suivant :

- (1) le logiciel développé indépendamment par ou pour Panasonic Corporation,
- (2) le logiciel appartenant à un tiers et sous licence Panasonic Corporation,
- (3) le logiciel sous licence GNU General Public License, Version 2.0 (GPL V2.0),
- (4) le logiciel sous licence GNU LESSER General Public License, Version 2.1 (LGPL V2.1) et/ou,
- (5) Logiciel "open source" autre que le logiciel sous licence GPL V2.0 et/ou LGPL V2.1.

Les logiciels classés comme (3) - (5) sont distribués dans l'espoir qu'ils pourraient être utiles, mais SANS AUCUNE GARANTIE, sans même la garantie implicite de COMMERCIALISATION ou D'ADAPTATION A UN USAGE PARTICULIER. Veuillez vous référer aux modalités et aux conditions de ceux-ci figurant dans "Manuel de référence".

Pendant au moins trois (3) ans à compter de la livraison de ce produit, Panasonic donnera à tout tiers qui nous contactera en utilisant les coordonnées ci-dessous, pour un montant non supérieur à notre coût pour la réalisation physique de la distribution du code source, une copie complète exploitable par ordinateur du code source correspondant, couvert par la GPL V2.0, LGPL V2.1 ou par d'autres licences avec l'obligation de le faire, ainsi que la notice des droits d'auteur respective.

Coordonnées de contact : [oss-cd-request@gg.jp.panasonic.com](mailto:oss-cd-request@gg.jp.panasonic.com)

Le code source et la notice des droits d'auteur sont également disponibles gratuitement sur notre site web suivant.

<http://panasonic.net/avc/oss/index.html>

# Specifications

This page provides the specifications for the basic model.  
The model number is different according to the unit configuration.

- To check the model number:  
Check the bottom of the computer or the box the computer came in at the time of purchase.
- To check CPU speed, memory size and the hard disk drive (HDD) size:  
Run the Setup Utility (→  *Reference Manual* "Setup Utility") and select [Information] menu.  
[Processor Speed]: CPU speed, [Memory Size]: Memory size, [Hard Disk]: Hard disk drive size

## ■ Main Specifications

CPU	Intel® Core™ i5-6300U Processor 2.4 GHz (3 MB <sup>11</sup> cache, up to 3.0 GHz with Intel® Turbo Boost Technology)	
Chip Set	Built-in CPU	
Video controller	Intel® HD Graphics 520 (Built-in CPU)	
Main Memory <sup>*2</sup>	4 GB <sup>*1</sup> / 8 GB <sup>*1</sup> , DDR3L SDRAM (16 GB <sup>*1</sup> Max.)	
Storage	Quick Release Drive: 500 GB <sup>*3</sup> / 1 TB <sup>*3</sup> (Hard disk drive) / 128 GB <sup>*3</sup> / 256 GB <sup>*3</sup> / 512 GB <sup>*3</sup> (SSD) <For boot drive> <b>Windows 10</b> Approx. 18 GB <sup>*3</sup> is used as a partition with disk recovery tools. (Users cannot use this partition.) Approx. 1.2 GB <sup>*3</sup> is used as a partition with system tools. (Users cannot use this partition.) <b>Windows 7</b> Approx. 25 GB <sup>*3</sup> is used as a partition with disk recovery tools. (Users cannot use this partition.) Approx. 300 MB <sup>*3</sup> is used as a partition with system tools. (Users cannot use this partition.)	
Display Method	14.0" (16:9) HD (1366 × 768 dots)	14.0" (16:9) FHD (1920 × 1080 dots)
Internal LCD <sup>*4</sup>	Max. 16,777,216 colors (1366 × 768 dots)	Max. 16,777,216 colors (1920 × 1080 dots)
External Display (HDMI) <sup>*5</sup>	65,536 / 16,777,216 colors (1920 × 1200 dots Max.)	
Wireless LAN <sup>*6</sup>	Intel® Dual Band Wireless-AC 8260 (a/b/g/n/ac) → page 39	
Bluetooth <sup>*7</sup>	→ page 39	
LAN	IEEE 802.3 10Base-T / IEEE 802.3u 100BASE-TX / IEEE 802.3ab 1000BASE-T	
Sound	WAVE and MIDI playback, Intel® High Definition Audio subsystem support	
SD Memory Card Slot <sup>*8</sup>	× 1	
RAM Module Slot (For extension)	× 1, DDR3L SDRAM, 204-pin, 1.35 V, SO-DIMM, PC3L-12800 Compliant	
Interface	USB Ports (USB 3.0 ports × 3) <sup>*9</sup> / LAN Port (RJ-45) × 1 / HDMI Port (Type A) <sup>*10</sup> / Headset (Miniature jack, 3.5 DIA, CTIA standard / Headphone: Impedance 32 Ω, Output Power 4 mW × 2, Stereo / Microphone: Monaural Input) / Expansion Bus Connector (Dedicated 24-pin female)	
Keyboard / Pointing Device	87 keys / Touchpad	87 keys / Touchpad <Only for model with touchscreen> 87 keys / Touchpad / Touchscreen (Capacitive)
Sensor	Ambient Light sensor	

# Specifications

## ■ Main Specifications

Power Supply		AC adaptor or Battery pack	
AC Adaptor <sup>*11</sup>		Input: 100 V - 240 V AC, 50 Hz/60 Hz, Output: 15.6 V DC, 7.05 A	
Battery Pack		Li-ion 11.1 V, Typical 4200 mAh / Minimum 4080 mAh (with CF-VZSU0PW)	
		Li-ion 10.8 V, Typical 3220 mAh / Minimum 3050 mAh (with CF-VZSU0LW)	
		Operating Time <sup>*12</sup>	Approx. 11 hours (with CF-VZSU0PW) Approx. 9 hours (with CF-VZSU0LW)
		Charging Time <sup>*13</sup>	Approx. 2.5 hours
Power Consumption <sup>*14</sup>		Approx. 65 W <sup>*15</sup> / Approx. 110 W (maximum when recharging in the ON state)	
Physical Dimensions (W × D × H) (including the carrying handle)		345 mm × 272 mm × 29.8 - 39 mm {13.6" × 10.7" × 1.2" - 1.54"}	
Weight		Approx. 1.99 kg {Approx. 4.39 lb.} (with CF-VZSU0PW)	<Only for model without touchscreen> Approx. 2.10 kg {Approx. 4.63 lb.} <Only for model with touchscreen> Approx. 2.20 kg {Approx. 4.85 lb.} (with CF-VZSU0PW)
Environment	Operating	Temperature	-10 °C to 50 °C {14 °F to 122 °F} (IEC60068-2-1, 2) <sup>*16</sup>
		Humidity	30 % to 80 % RH (No condensation)
	Storage	Temperature	- 20 °C to 60 °C {-4 °F to 140 °F}
		Humidity	30 % to 90 % RH (No condensation)

## ■ Software

Base OS		Windows 10 Pro 64-bit
Installed OS <sup>*17</sup>		<b>Windows 10</b> Windows 10 Pro 64-bit <b>Windows 7</b> Windows 7 Professional 32-bit Service Pack 1 (downgraded to Windows 7) <sup>*18</sup> / Windows 7 Professional 64-bit Service Pack 1 (downgraded to Windows 7) <sup>*18</sup>
Pre-installed Software		Intel® PROSet/Wireless Software <sup>*19</sup> , Intel® PROSet/Wireless Software for Bluetooth® Technology <sup>*19</sup> , Recovery Disc Creation Utility, Camera Utility <sup>*19</sup> , Manual Selector, Microsoft Office Trial <sup>*22</sup> , Intel® WiDi, DDS EVE FA Stand-alone for Panasonic <sup>*19*21</sup> , PC Information Viewer, GPS Viewer <sup>*19</sup> , Wireless Mobile Manager <sup>*21*23</sup> <b>Windows 10</b> Panasonic PC Settings Utility <sup>*20</sup> , Wireless Toolbox <b>Windows 7</b> Wireless Switch Utility, Wireless Connection Disable Utility <sup>*19*21</sup> , Battery Recalibration Utility, Dashboard for Panasonic PC, Power Plan Extension Utility, Touch Screen Mode Setting Utility <sup>*19</sup> , Adobe Reader, Infineon TPM Professional Package <sup>*19*21</sup> , Concealed Mode Settings Utility, USB Charge Setting Utility, Hotkey Settings Aptio Setup Utility, PC-Diagnostic Utility, Hard Disk Data Erase Utility <sup>*24</sup>

### ■ Wireless LAN\*6

Data Transfer Rates	IEEE802.11a : 54 Mbps <sup>*25</sup> IEEE802.11b : 11 Mbps <sup>*25</sup> IEEE802.11g : 54 Mbps <sup>*25</sup> IEEE802.11n <sup>*26</sup> : HT20 = 150 Mbps HT40 = 300 Mbps IEEE802.11ac : VHT80 : 866.7 Mbps VHT40 : 400 Mbps VHT20 : 173.3 Mbps
Standard Supported	IEEE802.11a / IEEE802.11b / IEEE802.11g / IEEE802.11n / IEEE802.11ac
Transmission Method	OFDM system, DS-SS system



### ■ Bluetooth\*7

Bluetooth Version	<b>Windows 10</b> 4.1/ <b>Windows 7</b> 4.0
	Classic mode / Low Energy mode
Transmission method	FHSS system
Wireless Channels Used	Channels 1 to 79 / Channels 0 to 39
RF Frequency Band	2.402 GHz - 2.480 GHz

### ■ Optional Devices

Storage	Onboard drive (Flash Memory Drive (SSD)):128 GB / 256 GB (M.2 basis)	
Discrete Video Controller*27	AMD FirePro™ M5100	
CD/DVD Drive	DVD MULTI Drive built-in, Buffer underrun error prevention function: Supported Further information, refer to  Reference Manual “CD/DVD Drive”	
Wireless WAN*28	LTE compatible	
GPS	Chip: u-blox M8 GPS/GLONASS/SBAS Support	
2nd LAN	IEEE 802.3 10Base-T / IEEE 802.3u 100BASE-TX / IEEE 802.3ab 1000BASE-T	
Security Chip*29	TPM (TCG V1.2 compliant)	
PC Card Slot	× 1, Type I or Type II, Allowable current 3.3 V: 400 mA, 5 V: 400 mA	
Smart Card Slot	× 1	
SIM Card Slot	× 1	
USB 2.0 port*9	× 1	
Rugged USB 2.0*9	× 1	
Serial Port	× 1, Dsub 9-pin male	
VGA Port	× 1, Mini Dsub D-sub 15	
Fingerprint Reader	Array Size : -, Image Size : 200×400 pixels, Image Resolution : 508 DPI	
Contactless Smart Card Reader	RF frequency: 13.56 MHz, compatible with ISO14443 Type-A, ISO14443 Type-B	
Camera*30	1920 × 1080 dots, 30 fps (Video) / 1920 × 1080 dots (Still), Stereo Microphone	
Battery Pack 2	(CF-VZSU0KW) Li-ion 11.1 V, Typical 2960 mAh / Minimum 2860 mAh	
	Operating Time*12	Approx. 18 hours (with CF-VZSU0PW + CF-VZSU0KW) Approx. 15 hours (with CF-VZSU0LW + CF-VZSU0KW)
	Charging Time*13	Approx. 5 hours (with CF-VZSU0PW/CF-VZSU0LW + CF-VZSU0KW)
Built-in bridge battery (not replaceable)	(For hot swap only)	

# Specifications

- <sup>\*1</sup> 1 MB = 1,048,576 bytes / 1 GB = 1,073,741,824 bytes
- <sup>\*2</sup> Memory size of the factory default depends on the model. You can physically expand the memory up to 16 GB, but the total amount of usable memory available will be less depending on the actual system configuration.
- <sup>\*3</sup> 1 MB = 1,000,000 bytes / 1 GB = 1,000,000,000 bytes / 1 TB = 1,000,000,000,000 bytes. Your operating system or some application software will report as fewer GB.
- <sup>\*4</sup> Depending on the OS settings.
- <sup>\*5</sup> Selectable resolution depends on the specifications of the external display. Display may be impossible using some connected external displays.
- <sup>\*6</sup> Only for model with wireless LAN.
- <sup>\*7</sup> Only for model with Bluetooth. Does not guarantee operation of all Bluetooth peripherals.
- <sup>\*8</sup> This slot is compatible with UHS-I / UHS-II. Operation has been tested and confirmed using Panasonic SD/SDHC Memory Cards with a capacity of up to 64 GB. Operation on other SD equipment is not guaranteed.
- <sup>\*9</sup> Does not guarantee operation of all USB-compatible peripherals.
- <sup>\*10</sup> Does not guarantee operation of all HDMI-compatible peripherals.
- <sup>\*11</sup> <Only for North America>  
The AC adaptor is compatible with power sources up to 240 V AC adaptor. This computer is supplied with a 125 V AC compatible AC cord. 20-M-2-1
- <sup>\*12</sup> Measured with LCD brightness : 60 cd/m<sup>2</sup>  
Varies depending on the usage conditions, or when an optional device is attached.
- <sup>\*13</sup> Varies depending on the usage conditions, CPU speed, etc.
- <sup>\*14</sup> Approx. 0.5 W when the battery pack is fully charged (or not being charged) and the computer is off. Even when the AC adaptor is not connected to the computer, power is consumed (Max. 0.15 W) simply by having the AC adaptor plugged into an AC outlet.
- <sup>\*15</sup> Rated power consumption. 23-E-1
- <sup>\*16</sup> Do not expose the skin to this product when using the product in a hot or cold environment. (→ OPERATING INSTRUCTIONS - Read Me First) When using in hot or cold environment, some peripherals and battery pack may fail to work properly. Check the operation environment of the peripherals. Using this product continuously in a hot environment will shorten the product life. Avoid use in these types of environments. When using in low temperature environment, startup may become slow or battery operation time may become short.  
The computer consumes power when the hard disk is warming up during startup. Therefore, if you are using battery power and the remaining power is low, the computer may not start up.
- <sup>\*17</sup> Operations of this computer are not guaranteed except for the pre-installed OS and the OS which is installed by using the hard disk recovery and the recovery disc.
- <sup>\*18</sup> This system is preinstalled with Windows 7 Professional software and also comes with a license for Windows 10 Pro software. You may only use one version of the Windows software at a time. Switching between versions will require you to uninstall one version and install the other version.
- <sup>\*19</sup> Depending on the models, this application software is not installed.
- <sup>\*20</sup> Panasonic PC Settings Utility includes the following functions: Ambient light sensor power management options / Battery Charge Speed / Battery Recalibration / Touch Operation Support / USB Charge Settings / Power Saving Settings
- <sup>\*21</sup> Must be installed before use.
- <sup>\*22</sup> To continue using this software after the end of the trial, purchase a license by following the on-screen instructions.
- <sup>\*23</sup> <For localized OS model>  
For information on Wireless Mobile Manager, refer to the “Supplementary Instructions for Wireless Manager mobile edition” by the following procedure.
- Windows 10**
- ① Right-click  (Start) at the bottom left corner.
  - ② Click [Run], input “c:\util\wlprjct\Supplementary Instructions.pdf” then click [OK].
- Windows 7**
- Click  (Start) and input “c:\util\wlprjct\Supplementary Instructions.pdf” in [Search programs and files] and press **Enter**.
- <sup>\*24</sup> Perform on the recovery disc.
- Windows 7**
- Alternatively perform on the hard disk recovery partition.
- <sup>\*25</sup> These are speeds specified in IEEE802.11a+b+g+n+ac standards. Actual speeds may differ.
- <sup>\*26</sup> Available when set to “WPA-PSK”, “WPA2-PSK” or “none”.
- <sup>\*27</sup> Only available when HT40 enabled by the computer and access point which associated supports HT40. Do not open the back cover. Removable By Trained Technician Only.



- <sup>\*28</sup> The specifications may differ depending on the model.  
A SIM card (15 mm {0.59"} × 25 {0.98"} mm) must be inserted in the SIM card slot.

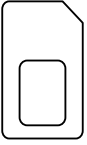

- <sup>\*29</sup> For information on TPM, refer to the Installation Manual of "Trusted Platform Module (TPM)" by the following procedure.  
Double-click [Manual Selector] on the desktop, and select "Installation Manual for Trusted Platform Module (TPM)".
- <sup>\*30</sup> The specifications may differ depending on the model.  
Depending on the specification of application software, the following cases may occur. In these cases, select a smaller resolution.
- Cannot select a large resolution.
  - When selecting a large resolution, an error occurs.

# LIMITED WARRANTY

**For U.S.A.**

Panasonic System Communications Company of North America (PSCNA)  
Computer Products - Worldwide Warranties

## **Section 1: Limited Warranty - Hardware**

PSCNA, referred hereafter as “Panasonic” will repair the products listed below with new or rebuilt parts, free of charge in a Global Panasonic designated service location for the period specified below from the date of original purchase in the event of a defect in materials or workmanship. These warranties are extended solely to the original purchaser. A purchase receipt or other proof of date of original purchase will be required before warranty performance is rendered.

- Laptop PC (CF-##) – 3 Years
- Ultra-Mobile (CF-U#/CF-H# Series) – 3 Years
- Tablet PC (FZ-##) – 3 Years
- PDRC - LCD & Keyboard Assembly – 3 Years

### **Battery Warranty**

Batteries supplied with the product are covered under the warranty for one (1) year from date of purchase, except as excluded in Section 3. Batteries purchased separately are covered under the warranty for one (1) year from the date of purchase. A replacement battery furnished under the product warranty is covered for the remaining period of the one year warranty on the original or purchased battery.

### **Optional: Panasonic “Protection Plus” Warranty**

Any unit for which the Panasonic “Protection Plus” warranty has been purchased will receive additional coverage for any failure that occurs due to accidental damage. All other terms and conditions of the standard warranty apply and this additional coverage will exist for the duration of the standard warranty period of the unit. If an extended Protection Plus warranty program is purchased, coverage is extended to the end of the last year of extended coverage purchased.

This warranty does not cover failures or defects that are caused by fire, intentional acts, loss, theft, improper maintenance, modification or service by anyone other than the Panasonic National Service Center or a Panasonic Authorized Service Provider, or damage that is attributable to acts of God. Cosmetic damage that does not affect functionality is not covered. Cosmetic damage on units with hardware failures will be repaired in accordance with the warranty terms. This warranty is extended solely to the original purchaser on the unit serial number for which it was purchased. Complete unit replacement fulfills the full obligation and is at the discretion of Panasonic and is limited to once during the coverage term. Maximum benefit is limited to one replacement per coverage year of the Motherboard, LCD, Storage Drive, and Keyboard.

### **Wireless Module Warranty**

Panasonic approved wireless modems installed in Panasonic brand computers and integrated by Panasonic or an Authorized Panasonic Wireless Integrator are covered under the warranty for the remaining warranty period of the device in which the modem is installed. For devices with less than three (3) months remaining on the unit warranty, the wireless modem will be covered for a period of three (3) months from the date of installation of the modem, covering only modem replacement or modem installation related issues.

All modems must be approved by the wireless carrier prior to use. Any use or attempted use of a wireless modem not approved and activated by the carrier for use on their network is strictly prohibited and is not sanctioned or warranted by Panasonic and may result in legal action. In addition, all modems must be approved by Panasonic as compatible with the device hardware before installation or use.

Panasonic’s sole responsibility for the warranty or technical support of the software required to install or operate the modem is defined in Section 2 (Limited Software Warranty). Any attempted software installation by anyone other than a Panasonic Authorized Wireless Integrator is not covered under warranty and may result in service charges to re-image or replace the hard drive.

Installation or attempted installation by any party other than Panasonic or an Authorized Panasonic Wireless Integrator is strictly not covered under the warranty and may void the computer warranty if damage results.

## Options and Accessories Warranties

The below listed Panasonic brand or supplied options and accessories are covered under this limited warranty for the period specified from the date of purchase or as specifically stated:

- AC Adaptor / Power Cord – 3 Years
- Memory Expansion Card (Panasonic Brand) – 3 Years
- Car Mount - Docking Station PCB or Vehicle Docking Station – 3 Years
- Desktop Port Replicator, I-O Box, Docking Cradle (like CF-U1) – 3 Years
- Antenna Pass-through Cable – 3 Years
- Backlit or Full-sized keyboard - 3 Years or assumes warranty of the unit in which it is installed
- Integrated Panasonic supplied options and kits including, but not limited to Wireless Modems, Media Bay Drives (Floppy, CD, DVD, Combo), Camera, GPS, Bluetooth, Smartcard Reader, Magnetic Card Reader, Barcode Scanner, and Fingerprint Reader - 3 Years or assumes warranty period of the unit in which it is installed provided the integration was performed by Panasonic or an Authorized Integrator.
- Hard Drive / Solid State Drive (Internal) - 3 Years
- Separately purchased 2nd Hard Drive – 1 Year
- External USB Drives (CD / DVD / Floppy / Hard Drive) – 1 Year
- Optional Battery – 1 Year
- Battery Charger / Multi-Bay Battery Charger – 1 Year
- Stylus Pens, Digitizer & Standard - 90 Days (physical damage excluded)

## Section 2 - Limited Warranty - Software

Panasonic warrants to you only that the disk(s) or other media on which the Programs are furnished will be free from defects in material and workmanship under normal use for a period of sixty (60) days from the date of delivery thereof to you, as evidenced by your purchase receipt.

This is the only warranty Panasonic makes to you. Panasonic does not warrant that the functions contained in the Programs will meet your requirements or that the operation of the Programs will be uninterrupted or error free. Panasonic shall have no obligation for any defects in the disk(s) or other media on which the Programs are furnished resulting from your storage thereof, or for defects that have been caused by operation of the disk(s) or other media

Panasonic's entire liability and your exclusive remedy under this warranty shall be limited to the replacement, in the United States or other Panasonic designated location, of any defective disk or other media which is returned to Panasonic's Authorized Service Center, together with a copy of the purchase receipt, within the aforesaid warranty period.

## Section 3 - Limited Warranty Exclusions - Specifically excluded from the warranty are:

- All consumable items; such as screen protection films, logo badges, labels, cleaning cloths, carry cases, manuals, cables, straps, belts, holsters, tethers, and harnesses and any other options and accessories not listed above or covered under a separate warranty.
- Failures related to the product operating system, hard drive or solid state drive image, software setup, software program, virus, other program(s) or file(s) on any drive or in any computer memory location.
- Failures due to BIOS settings or changes, as well as any cosmetic or physical damage to the unit.
- Any unit or device with a missing or altered model number or serial number label
- Cosmetic damage or any damage which occurs in shipment
- Failures which are caused by products not supplied by Panasonic
- Failures which result from alteration, accident, misuse, introduction of liquid or other foreign matter into the unit, abuse, neglect, installation, maladjustment of consumer controls, improper maintenance or modification, use not in accordance with product use instructions
- Failures due to service by anyone other than a Panasonic Authorized Service Provider
- Failures caused by improper installation of options or accessories or due to integration by any company other than Panasonic or a Panasonic Authorized Integrator
- Damage, failure, or loss due to the unit being stolen, lost, misplaced, or used by anyone other than the original purchaser
- Damage that is attributable to acts of God

# LIMITED WARRANTY

This limited warranty only covers failures due to defects in materials or workmanship which occur during normal use. If a unit is sent to a Panasonic Authorized Service Center and no hardware failure is found, the customer will be billed for labor to correct a software issue or reimage the hard drive plus shipping and applicable administrative fees at the current rates set by the service provider.

THIS PRODUCT IS NOT INTENDED FOR USE AS OR PART OF NUCLEAR EQUIPMENT/SYSTEMS, AIR TRAFFIC CONTROL EQUIPMENT/SYSTEMS, OR AIRCRAFT COCKPIT EQUIPMENT/SYSTEMS<sup>\*1</sup>. PANASONIC WILL NOT BE RESPONSIBLE FOR ANY LIABILITY RESULTING FROM THE USE OF THIS PRODUCT ARISING OUT OF THE FOREGOING USES.

<sup>\*1</sup> AIRCRAFT COCKPIT EQUIPMENT/SYSTEMS include class 2 Electrical Flight Bag (EFB) Systems and Class 1 EFB Systems when used during critical phases of flight (e.g., during take-off and landing) and/or mounted onto the aircraft. Class 1 EFB Systems and 2 EFB Systems are defined by FAA: AC (Advisory Circular) 120-76A or JAA: JAA TGL (Temporary Guidance Leaflets) No. 36.

**Other Limits and Exclusions: There are no other express warranties except as listed above.**

PANASONIC SHALL NOT BE LIABLE FOR LOSS OF DATA OR OTHER INCIDENTAL OR CONSEQUENTIAL DAMAGES RESULTING FROM THE USE OF THIS PRODUCT, OR ARISING OUT OF ANY BREACH OF THIS WARRANTY. ALL EXPRESS AND IMPLIED WARRANTIES, INCLUDING THE WARRANTIES OF MERCHANTABILITY AND FITNESS FOR A PARTICULAR PURPOSE ARE LIMITED TO THE APPLICABLE WARRANTY PERIOD SET FORTH ABOVE. Some states do not allow the exclusion or limitation of incidental or consequential damages, or limitations on how long an implied warranty lasts, so the above limitations or exclusions may not apply to you.

This limited warranty gives you specific legal rights, and you may also have other rights which vary from state to state.

For technical support or to arrange for service on your Panasonic computer product, call our toll-free hotline at 1-855-PSC-TECH (855-772-8324).

DIAL TOLL FREE: 1-855-PSC-TECH (855-772-8324)  
Web Site : [www.panasonic.com/toughbook](http://www.panasonic.com/toughbook)

## For Canada

### PANASONIC COMPUTER AND PERIPHERALS LIMITED WARRANTY

**Coverage** – Panasonic Canada Inc. (“PCI”) warrants to you, the first end user customer, this computer product (excluding software media), when purchased from PCI or from a PCI authorized reseller, to be free from defects in materials and workmanship under normal use, subject to the terms set forth below, during the period of warranty coverage specified.

Scope of Coverage	Period of Coverage	Type of Failure Coverage
<ul style="list-style-type: none"> <li>• Laptop Computers (except Battery) and AC Adaptor</li> <li>• Factory/PCI installed options including Wireless WAN, GPS, Bluetooth, Finger print reader, Backlit keyboard, Memory Card and Media Bay Drives (Floppy, CD/DVD)</li> <li>• Ultra-Mobile PC</li> <li>• Tablet PC</li> <li>• Mobile Wireless Display</li> <li>• PDRC – LCD and Keyboard Assemblies</li> <li>• Port Replicator</li> </ul>	Three (3) Years from Date of Original End User Customer Purchase	Defective Materials or Workmanship
<ul style="list-style-type: none"> <li>• Hand-held Computers</li> <li>• Battery</li> <li>• Battery charger</li> <li>• Auto Adaptor</li> <li>• External USB Drives</li> </ul>	One (1) Year from Date of Original End User Customer Purchase	Defective Materials or Workmanship
<ul style="list-style-type: none"> <li>• Standard or Digitizer Stylus Pen</li> </ul>	Ninety (90) Days from Date of Original End User Customer Purchase	Defective Materials or Workmanship
<ul style="list-style-type: none"> <li>• All consumable items including protection film, cleaning cloth, carry case, tether and harness</li> </ul>	No Coverage	

**Remedy** – In the event of a warranty claim, contact PCI’s representatives within the applicable warranty period, identifying the nature of the defect claimed, at 1-800-668-8386 between 9:00 A.M. and 5:00 P.M., Eastern Time Zone, Mon. – Fri. (excluding holidays) for instructions on how to obtain service. A purchase receipt or other proof of date of original purchase is required before warranty service is performed. Defective parts covered by this Limited Warranty will be repaired or replaced with new or comparable rebuilt parts on an exchange basis. Warranty replacement or repair is subject to the terms of this Limited Warranty for the balance of the original period of warranty coverage.

**No Coverage** – This Limited Warranty does not cover products purchased outside Canada. Neither does it cover damage to, failure of, or defects in a product or accessory through mishandling, improper installation, abnormal use, misuse, neglect, accident, introduction of liquid or other foreign matter into the product, alteration or servicing by anyone not authorized by PCI, or act of God. THIS PRODUCT IS NOT INTENDED FOR USE AS, OR AS PART OF, NUCLEAR EQUIPMENT/SYSTEMS, AIR TRAFFIC CONTROL EQUIPMENT/SYSTEMS, OR AIRCRAFT COCKPIT EQUIPMENT/SYSTEMS<sup>2</sup>. PANASONIC WILL NOT BE RESPONSIBLE FOR ANY LIABILITY RESULTING FROM THE USE OF THIS PRODUCT ARISING OUT OF THE FOREGOING USES.

<sup>2</sup> AIRCRAFT COCKPIT EQUIPMENT/SYSTEMS include Class2 Electrical Flight Bag (EFB) Systems and Class1 EFB Systems when used during critical phases of flight (e.g., during take-off and landing) and/or mounted on to the aircraft. Class1 EFB Systems and 2 EFB Systems are defined by FAA: AC (Advisory Circular) 120-76A or JAA: JAA TGL (Temporary Guidance Leaflets) No.36

#### IF YOU SHIP THE PRODUCT FOR WARRANTY SERVICE

Carefully pack the product, preferably in the original carton. Include details of defect claimed and proof of date of original purchase. No liability is assumed for loss or damage to the product while in transit, if you chose your own transportation carrier.

# LIMITED WARRANTY

## SOFTWARE MEDIA LIMITED WARRANTY

**Coverage** – PCI warrants to you, the first end user customer, that the disk(s) or other media on which software program(s) is/are supplied will be free from defects in materials and workmanship under normal use in Canada for a period of sixty (60) days from date of receipt as evidenced by your purchase receipt for your Panasonic Computer product.

THIS IS THE ONLY WARRANTY THAT PCI MAKES RESPECTING THE SOFTWARE MEDIA. PCI does not warrant the software. Please refer to the software licensor's written warranty (accompanying the copy of the software) for any software warranty claim.

**Claim Procedure** – In the event of a defect in material or workmanship in the media during the sixty (60) days warranty period, and you return it, transportation costs prepaid, to Panasonic Canada Inc., Computer Products Marketing, 5770 Ambler Drive, Mississauga, Ontario L4W 2T3, within the warranty period, together with a copy of your purchase receipt, and an explanation of the suspected defect, PCI will replace in Canada the defective disk(s) or other media.

**Remedy** – PCI's entire liability, and your only remedy for any breach of this software media warranty is limited to replacement of the media only. It does not cover any other damages, including, but not limited to, loss of use or profit loss, or special, indirect or consequential damages, or other claims, whether or not of similar character.

**No Coverage** – This limited warranty does not apply if the disk(s) or other media has been used in other than a Panasonic product, or in environmental conditions other than those specified by PCI or the manufacturer, or if subjected to misuse, neglect, mishandling, modification or attempted modification of the program, or if damaged by accident or act of God. PCI is not responsible for damage to or loss of any program, data or removable storage media.

## GENERAL

**NO OTHER WARRANTIES** – PCI DISCLAIMS ALL OTHER WARRANTIES, EITHER EXPRESS OR IMPLIED, INCLUDING, BUT NOT LIMITED TO, IMPLIED WARRANTIES OF MERCHANTABILITY AND FITNESS FOR A PARTICULAR PURPOSE, WITH RESPECT TO THE SOFTWARE, SOFTWARE MEDIA, COMPUTER PRODUCT, OPTIONS AND ACCESSORIES.

**NO LIABILITY FOR CONSEQUENTIAL DAMAGES** – IN NO EVENT SHALL PCI BE LIABLE FOR ANY SPECIAL, INDIRECT OR CONSEQUENTIAL DAMAGES ARISING FROM ANY BREACH OF THE LIMITED WARRANTIES SET OUT IN THIS DOCUMENT, OR FROM THE USE OF THE COMPUTER PRODUCT, INCLUDING, WITHOUT LIMITATION, LOSS OF DATA, BUSINESS, PROFIT OR GOODWILL. IN ANY EVENT, PCI'S MAXIMUM LIABILITY FOR ANY BREACH SHALL NOT EXCEED THE AMOUNT ACTUALLY PAID BY YOU FOR THE COMPUTER PRODUCT.

**NO ACTION, REGARDLESS OF ITS BASIS, MAY BE BEGUN AGAINST PCI MORE THAN TWO (2) YEARS AFTER THE CAUSE OF ACTION AROSE.**

**Statutory Warranties** – Some jurisdictions do not allow these limitations or exclusions, so they may not apply to you.

# LIMITED WARRANTY (GARANTIE LIMITÉE)

## Pour le Canada

### GARANTIE LIMITÉE – ORDINATEURS ET PÉRIPHÉRIQUES PANASONIC

**Couverture** – Panasonic Canada Inc. (« PCI ») garantit à l'acheteur original que ce produit informatique (à l'exclusion des supports des logiciels) est, au moment de sa vente par PCI ou d'un revendeur agréé par PCI, exempt de défauts de pièces et de fabrication dans les conditions normales d'utilisation, et ce, pendant la période de couverture de la garantie, sous réserve des modalités décrites ci-dessous.

Éléments couverts	Durée de couverture	Type de couverture
<ul style="list-style-type: none"><li>• Ordinateurs blocs-notes (sauf batteries) et adaptateur secteur</li><li>• Options installées en usine/par PCI incluant : WAN sans fil, GPS, Bluetooth, lecteur d'empreintes digitales, clavier rétroéclairé, carte mémoire et lecteurs (disquettes, CD/DVD)</li><li>• Ordinateurs personnels ultra-portables</li><li>• Ordinateurs tablettes</li><li>• Écran mobile sans fil</li><li>• Ensembles PDRC – ACL et clavier</li><li>• Duplicateur de port</li></ul>	Trois (3) ans à partir de la date d'achat original.	Défauts de pièces et de fabrication
<ul style="list-style-type: none"><li>• Ordinateurs de poche</li><li>• Batterie</li><li>• Chargeur de batterie</li><li>• Adaptateur pour voiture</li><li>• Périphériques USB</li></ul>	Un (1) an à partir de la date d'achat original.	Défauts de pièces et de fabrication
<ul style="list-style-type: none"><li>• Stylo pointeur standard ou pour numériseur graphique</li></ul>	Quatre-vingt-dix (90) jours à partir de la date d'achat original.	Défauts de pièces et de fabrication
<ul style="list-style-type: none"><li>• Tous les articles consommables incluant les pellicules protectrices, chiffons de nettoyage, étuis de transport, longues et sangles</li></ul>	Aucune couverture	

**Recours** – Pour obtenir des informations sur la marche à suivre dans le cas où une réclamation en vertu de la garantie deviendrait nécessaire, communiquez par téléphone avec un représentant de PCI au 1-800-668-8386, entre 9h00 et 17h00 (heure de l'Est) du lundi au vendredi (sauf les jours fériés), avant l'échéance de la garantie applicable, en prenant soin d'identifier la nature de la défaillance.

Un reçu ou toute autre pièce justificative de la date d'achat original sera exigé avant toute réparation. Toute pièce défectueuse couverte par la présente garantie limitée sera réparée ou remplacée par une pièce neuve ou remise à neuf. Le remplacement ou la réparation sera fait conformément aux modalités de la présente garantie limitée pendant la durée restante de la période originale de la garantie.

**Produits non couverts** – La présente garantie limitée ne couvre pas les produits achetés à l'extérieur du Canada. Elle ne couvre pas non plus les dommages, la défaillance ou les défauts attribuables à une maintenance inadéquate, une mauvaise installation, une utilisation anormale ou abusive, de la négligence, un accident, un déversement ou la pénétration d'un objet étranger, une modification, un cas fortuit ou une réparation effectuée par une personne non agréée par PCI.

CÉ PRODUIT N'EST PAS DESTINÉ À ÊTRE UTILISÉ, EN TOUT OU EN PARTIE, COMME SYSTÈME/ÉQUIPEMENT NUCLÉAIRE, SYSTÈME/ÉQUIPEMENT DE CONTRÔLE DU TRAFFIC AÉRIEN OU SYSTÈME/ÉQUIPEMENT DE POSTE DE PILOTAGE D'AVION<sup>3</sup>. PANASONIC DÉCLINE TOUTE RESPONSABILITÉ CONCERNANT L'UTILISATION DE CE PRODUIT DANS LES CAS SUSMENTIONNÉS.

<sup>3</sup> Les SYSTÈMES/ÉQUIPEMENTS DE POSTE DE PILOTAGE D'AVION sont dotés de systèmes OEPP (organiseur électronique de poste de pilotage) de classe 2 et de classe 1 utilisés pendant des phases critiques de vol (par exemple, pendant le décollage et l'atterrissage) et/ou montés sur l'avion. Les systèmes OEPP de classe 1 et de classe 2 sont définis par le circulaire d'information FAA: AC (Advisory Circular) 120-76A ou le feuillet n° 36 JAA: JAA TGL (Temporary Guidance Leaflets) No 36.

### EXPÉDITION DU PRODUIT POUR SERVICE SOUS GARANTIE

Emballer soigneusement le produit, de préférence dans son emballage d'origine. Joignez une description de la défaillance de même qu'une pièce justificative de la date d'achat. Panasonic Canada Inc. ne peut être tenue responsable pour tout dommage ou perte subi pendant le transport si vous avez choisi le transporteur.

# LIMITED WARRANTY

## **GARANTIE LIMITÉE – SUPPORTS DES LOGICIELS**

**Couverture** – Panasonic Canada Inc. (« PCI ») garantit à l'acheteur original que la ou les disquettes ou tout autre support sur lequel le ou les programmes sont fournis sont exempts de défauts de pièces et de fabrication dans des conditions normales d'utilisation au Canada, et ce, pour une période de soixante (60) jours suivant la date de réception indiquée sur la preuve d'achat.

LA PRÉSENTE GARANTIE EST LA SEULE OFFERTE PAR PCI COUVRANT LES SUPPORTS DE LOGICIELS. PCI ne garantit pas les logiciels. Reportez-vous à la garantie écrite du concédant de licence d'utilisation du logiciel (qui accompagne la copie du logiciel) pour toute réclamation en vertu de la garantie.

**Réclamation – marche à suivre** – Panasonic Canada Inc. remplacera toute disquette ou support défectueux si l'article en question est retourné, port payé, à son service de Marketing – produits informatiques, 5770 Ambler Drive, Mississauga (Ontario) L4W 2T3, dans les soixante (60) jours suivant la date d'achat original. Joignez à votre envoi une pièce justificative de votre achat et une description du problème.

**Recours** – La responsabilité de PCI - et votre seul recours - dans le cas de toute défaillance couverte par la garantie sur ce support de logiciel est limitée au seul remplacement du support. Elle ne couvre aucun autre dommage, y compris, mais non exclusivement, la perte d'usage ou de profits, ni aucun dommage spécial, indirect ou consécutif, ni aucune autre réclamation de nature similaire ou autre.

**Produits non couverts** – La présente garantie limitée ne s'applique pas si la ou les disquettes ou autre support ont été utilisés dans un produit d'une marque autre que Panasonic ou dans des conditions environnementales autres que celles spécifiées par PCI ou le fabricant, ou soumis à une mauvaise utilisation, à la négligence, à une manutention inadéquate ou encore si le programme a été modifié ou subi une tentative de modification ou des dommages attribuables à un accident ou à un cas fortuit. De plus, PCI n'assume aucune responsabilité pour toute perte de, ou tout dommage à, un programme, des données ou un support de sauvegarde amovible.

## **GÉNÉRALITÉS**

PCI NE RECONNAÎT AUCUNE AUTRE GARANTIE, EXPLICITE OU IMPLICITE, Y COMPRIS, MAIS NON EXCLUSIVEMENT, LES GARANTIES IMPLICITES DE VALEUR COMMERCIALE ET D'UTILITÉ À UNE FIN QUELCONQUE, À L'ÉGARD DU LOGICIEL, SUPPORTS DE LOGICIELS, PRODUITS INFORMATIQUES, PÉRIPHÉRIQUES ET ACCESSOIRES.

SOUS AUCUNE CIRCONSTANCE PCI NE POURRA ÊTRE TENUE RESPONSABLE DES DOMMAGES SPÉCIAUX, INDIRECTS OU CONSÉCUTIFS ATTRIBUABLES À UN MANQUEMENT AUX GARANTIES LIMITÉES DÉCRITES DANS LE PRÉSENT DOCUMENT OU À L'UTILISATION DU PRODUIT INFORMATIQUE, Y COMPRIS, SANS RESTRICTION, LA PERTE DE DONNÉES, D'AFFAIRES, D'ACHALANDAGE OU DE PROFIT.

DANS TOUS LES CAS, LA RESPONSABILITÉ MAXIMALE DE PCI POUR TOUT MANQUEMENT NE POURRA EXCÉDER LE PRIX DE VENTE DU PRODUIT INFORMATIQUE.

AUCUNE RÉCLAMATION, SANS ÉGARD À SES MOTIFS, NE POURRA ÊTRE FAITE AUPRÈS DE PCI PLUS DE DEUX (2) ANS APRÈS LES FAITS INVOQUÉS À LA BASE D'UNE TELLE RÉCLAMATION.

**Garantie statutaires** – Certaines juridictions interdisent de telles limitations ou exclusions; aussi, pourraient-elles ne pas s'appliquer.



## For Australia

### Personal / Notebook Computers - 36 Month Warranty from Date of Purchase

1. Subject to the conditions of this warranty Panasonic or its Authorised Service Centre will perform necessary service on the product without charge for parts or labour, if in the opinion of Panasonic, the product is found to be faulty within the warranty period.
2. This warranty only applies to Panasonic products purchased in Australia and sold by Panasonic Australia or its Authorised Distributors or Dealers and only where the products are used and serviced within Australia or its territories. Warranty cover only applies to service carried out by a Panasonic Authorised Service Centre and only if valid proof of purchase is presented when warranty service is requested.
3. This warranty only applies if the product has been installed and used in accordance with the manufacturer's recommendations (as noted in the operating instructions) under normal use and reasonable care (in the opinion of Panasonic). The warranty covers normal domestic use only and does not cover damage, malfunction or failure resulting from use of incorrect voltages, incorrect installation, accident, misuse, neglect, build-up of dirt or dust, abuse, maladjustment of customer controls, mains supply problems, thunderstorm activity, infestation by insects or vermin, tampering or repair by unauthorised persons (including unauthorised alterations), exposure to abnormally corrosive conditions or any foreign object or matter having entered the product.
4. This warranty does not cover the following items unless the fault or defect existed at the time of purchase: Software
5. Warranty on Toughbook accessories (stylus, pens, AC charger, combo drive, etc) is 12 Months from the date of purchase & 3 months for batteries.
6. To claim warranty service, when required, you should:  
Check the Panasonic web site for latest warranty contact <http://www.panasonic.com/au/business/computers-tablets-and-pos/toughbook.html>, use the Service Centre Locator and call the National Service Centre number indicated.  
Prepare purchase receipt as proof of purchase date and system serial number which will be required by the Authorised Service Centre.
7. The Warranty excludes 3 or less faulty pixels on screen.
8. The Warranty includes the repair or exchange of faulty parts within the product with items that are functionally equivalent to that as originally supplied or better – including new or refurbished parts or units – solely at Panasonic's discretion.
9. It is the customer's responsibility to backup all data from the hard disk drive before sending equipment for repair. If a problem is related to the hard disk drive, or the hard disk drive has to be replaced, Panasonic will only reload the factory pre-installed software for the product onto the replacement drive.
10. Panasonic will arrange free pick up and return for approved warranty repairs within 50 km of capital city locations. Please ensure your unit is properly packed for return to the service location.
11. The warranties hereby conferred do not extend to, and exclude, any costs associated with the installation, de-installation or re-installation of a product, including costs related to the mounting, demounting or remounting of any screen, (and any other ancillary activities), delivery, handling, freight, transportation or insurance of the product or any part thereof or replacement of and do not extend to, and exclude, any damage or loss occurring by reason of, during, associated with, or related to such installation, de-installation, re-installation or transit.

In addition to your rights under this warranty, Panasonic products come with consumer guarantees that cannot be excluded under the Australian Consumer Law. If there is a major failure with the product, you can reject the product and elect to have a refund or to have the product replaced or if you wish you may elect to keep the goods and be compensated for the drop in value of the goods. You are also entitled to have the product repaired or replaced if the product fails to be of acceptable quality and the failure does not amount to a major failure.

If there is a major failure in regard to the product which cannot be remedied then you must notify us within a reasonable period by contacting the Panasonic Customer Care Centre. If the failure in the product is not a major failure then Panasonic may choose to repair or replace the product and will do so in a reasonable period of time from receiving notice from you.

# LIMITED WARRANTY

THIS PRODUCT IS NOT INTENDED FOR USE AS OR AS PART OF NUCLEAR EQUIPMENT/SYSTEMS, AIR TRAFFIC CONTROL EQUIPMENT/SYSTEMS, OR AIRCRAFT COCKPIT EQUIPMENT/SYSTEMS<sup>4</sup>. PANASONIC WILL NOT BE RESPONSIBLE FOR ANY LIABILITY RESULTING FROM THE USE OF THIS PRODUCT ARISING OUT OF THE FOREGOING USES.

<sup>4</sup> AIRCRAFT COCKPIT EQUIPMENT/SYSTEMS include Class 2 Electrical Flight Bag (EFB) Systems and Class 1 EFB Systems when used during critical phases of flight (e.g., during take-off and landing) and/or mounted onto the aircraft. Class 1 EFB Systems and 2 EFB Systems are defined by FAA: AC (Advisory Circular) 120-76A or JAA: JAA TGL (Temporary Guidance Leaflets) No.36.

THIS WARRANTY CARD AND THE PURCHASE DOCKET (OR SIMILAR PROOF OF PURCHASE)  
SHOULD BE RETAINED BY THE CUSTOMER AT ALL TIMES

If you require assistance regarding warranty conditions or any other enquiries, please visit the **Panasonic Australia** website <http://www.panasonic.com/au/business/computers-tablets-and-pos/toughbook.html> or contact by phone on **1300 132 463**

## **Panasonic Australia Pty. Limited**

ACN 001 592 187 ABN 83 001 592 187

1 Innovation Road, Macquarie Park NSW 2113

[www.panasonic.com.au](http://www.panasonic.com.au)

PRO-031-F05 Issue: 4.0

11-11-2011

## For Europe

### Panasonic System Communications Company Europe

Panasonic System Communications Company Europe (referred to as "Panasonic") will repair this product (other than software, which is treated in a different section of this warranty) with new or refurbished parts, from the date of original purchase in the event of a defect in materials or workmanship. This warranty only applies to new Panasonic Toughbooks purchased in the EEA and Switzerland and Turkey.

Panasonic (or its authorised Service Provider) target to repair your equipment within 48 hours from its receipt in our service centre.

Additional charges may apply for shipment to countries outside of the European Union. Panasonic will use all reasonable endeavours to ensure this service.

This warranty only covers failures due to defects in materials or workmanship which occur during normal use for the applicable Service Agreement Period listed below. In the event that any product (or part thereof) is replaced, Panasonic shall transfer ownership of the replacement product (or part) to the customer and the customer shall transfer ownership of the replaced product (or part) to Panasonic.

#### Service Agreement Period - from original date of purchase

- Toughbooks (and every accessory included in the original packaging except the battery) - 3 years
- Toughpads (and every accessory included in the original packaging except the battery) - 3 years
- Accessories included in the original package - 3 years
- Additional peripherals manufactured by Panasonic (including media bay devices such as CD-Rom drives) - 1 year
- Batteries - 6 months. Panasonic Warranty covers the battery for six months. A battery is considered good if it maintains 50% of its charge capacity during the warranty period. If a battery is returned under this contract and testing determines that it has charge capacity greater than 50%, the battery will be returned with an invoice for the retail purchase price of a new battery.

This warranty is extended solely to the original purchaser. A purchase receipt or other proof of date of original purchase will be required before warranty performance is rendered.

#### Limits and Exclusions:

This warranty does not cover and shall be void for:

- Broken or cracked LCD screen.
- Defective pixel in notebook displays and LCD screens within 0.002%
- Damage that is attributable to fire, theft or acts of God.
- Damage caused by environmental influences (electrical storms, magnetic fields etc.).
- Damage which has not been caused during normal operation
- Repair of damage that is cosmetic only or does not affect product functionality such as wear and tear, scratches and dents.
- Failures caused by products not supplied by Panasonic.
- Failures resulting from alteration, accidental damage, casualty, misuse, abuse or neglect.
- Introduction of liquid or other foreign matter into the unit.
- Improper installation, operation or maintenance.
- Improper connections with peripherals.
- Maladjustment of consumer controls such as function settings.
- Modification or service by anyone other than Panasonic or its approved Service Providers.
- Products used as short term rental or leased equipment.
- Products whose serial number has been removed making the unit warranty condition impossible to clearly determine.

# LIMITED WARRANTY

THIS PRODUCT IS NOT INTENDED FOR USE AS, OR AS PART OF, NUCLEAR EQUIPMENT/SYSTEMS, AIR TRAFFIC CONTROL EQUIPMENT/SYSTEMS, OR AIRCRAFT COCKPIT EQUIPMENT/SYSTEMS. PANASONIC WILL NOT BE RESPONSIBLE FOR ANY LIABILITY RESULTING FROM THE USE OF THIS PRODUCT ARISING OUT OF THE FOREGOING USES.

There are no other express warranties except as listed above.

We strongly recommend that customers backup their data before sending back their unit to an Authorised Service Provider.

Panasonic shall not be liable for loss of data or other incidental or consequential damages resulting from the use of this product, or arising out of any breach of this warranty. All express and implied warranties, including the warranties of satisfactory quality and fitness for a particular purpose are limited to the applicable warranty period set forth above. Panasonic shall not be liable for any indirect, special or consequential loss or damage (including without limitation any loss of profits) arising from the use of this product or for any breach of this warranty.

This limited warranty gives you specific legal rights, and you may have other rights that vary from country to country. You must consult the applicable country laws for a full determination of your rights. This limited warranty is in addition to, and does not affect any rights arising out of any contract of sale or by statute.

## Panasonic System Communications Company Europe

### Data Storage Media

Data Storage Media is the media on which the Operating System, drivers and programs originally installed by Panasonic on the main unit are stored. This media is originally provided with the unit.

Panasonic warrants to you only that the disc(s) or other media on which the Programs are furnished will be free from defects in material and workmanship under normal use for a period of sixty (60) days from the date of delivery thereof to you, as evidenced by your purchase receipt.

This is the only warranty Panasonic makes to you. Panasonic does not warrant that the functions contained in the Programs will meet your requirements or that the operation of the Programs will be uninterrupted or error free.

Panasonic's entire liability and your exclusive remedy under this warranty shall be limited to the replacement of any defective disk or other media which is returned to Panasonic's authorized Service Centre, together with a copy of the purchase receipt, within the aforesaid warranty period.

Panasonic shall have no obligation for any defects in the disk(s) or other media on which the Programs are furnished resulting from your storage thereof, or for defects that have been caused by operation of the disk(s) or other media otherwise than on the Product or in the environment conditions other than those specified by Panasonic by alteration, accident, misuse, abuse, neglect, mishandling, misapplication, installation, maladjustment of consumer controls, improper maintenance, modification or damage that is attributable to acts of God. In addition, Panasonic shall have no obligation for any defects in the disk(s) or other media if you have modified, or attempted to modify any Program.

Duration of implied warranties, if any is limited to sixty (60) days.

### Pre-installed software

Pre-installed software means the software shipped pre-loaded by Panasonic, not that loaded by any third party or selling agent.

Panasonic and its suppliers makes no warranty, either express, implied or statutory, with respect to software provided with the Product and licensed to Purchaser, its quality, performance, merchantability, or fitness for a particular purpose. Panasonic does not warrant that the functions contained in the software will be uninterrupted or error free. Panasonic assumes no risk of and shall not in any case be liable for any damages, including, without limitation, any special, incidental, consequential, or punitive damages arising from breach of warranty or contract, negligence or any other legal theory, including, without limitation loss of goodwill, profits or revenue, loss of use of the Programs or Products or any associated equipment, cost of capital, cost of any substitute equipment, facilities, or services, downtime costs, or claims of any party dealing with such damages.

Some countries do not allow the exclusion or limitation of incidental or consequential damages, or limitations on how long an implied warranty lasts, so the above limitations or exclusions may not apply to you.

This limited warranty gives you specific legal rights and you may also have other rights that vary from country to country. You must consult applicable country laws for a full determination of your rights.

## Contacts

### Address

Panasonic System Communications  
Company Europe  
Panasonic Manufacturing U.K. Ltd.  
Service Centre Building B4,  
Wharfedale Road, Pentwyn Industrial  
Estate, Cardiff,  
United Kingdom  
CF23 7XB

### Web page

<http://www.toughbook.eu/>

### Helpdesk

English speaking service  
French speaking service  
German speaking service  
Italian speaking service  
Spanish speaking service  
Austria  
Switzerland (German)  
Switzerland (French)  
E-mail address

+44 (0) 800 0884324  
+33 (0) 80 5636449  
+49 (0) 800 7235211  
+39 800 986915  
+34 (0) 901 101 157  
+43 (0) 800 006493  
+41 (0) 800 002429  
+41 (0) 800 588017  
[toughbooksupport@eu.panasonic.com](mailto:toughbooksupport@eu.panasonic.com)

Czech speaking service  
Hungarian speaking service  
Polish speaking service  
Romanian speaking service  
Slovakian speaking service  
E-mail address

+420 (0) 800 143234  
+36 (0) 6800 163 67  
+48 (0) 800 4911558  
+40 (0) 800 894 743  
+421 (0) 800 42672627  
[toughbooksupport@csg.de](mailto:toughbooksupport@csg.de)

### Payments

[toughbookservicepayments.cardiff@eu.panasonic.com](mailto:toughbookservicepayments.cardiff@eu.panasonic.com)

---

**Panasonic Corporation**

Osaka, Japan

**Panasonic System Communications Company of North America**

Two Riverfront Plaza

Newark, NJ 07102

**Panasonic Canada Inc.**

5770 Ambler Drive, Mississauga,

Ontario L4W 2T3

**Panasonic Australia Pty. Limited**

ACN 001 592 187 ABN 83 001 592 187

1 Innovation Road, Macquarie Park NSW 2113

Importer's name & address pursuant to the EU legislation

**Panasonic System Communications Company Europe,****Panasonic Marketing Europe GmbH**

Hagenauer StraÙ 43

65203 Wiesbaden

Germany

Web Site : <http://panasonic.net/avc/pc/>