



# Taj Mahal:

AGRA, INDIA  
AGRA, INDE

**LEGO**

Architecture

Booklet available in English on  
Livret disponible en français sur  
Folleto disponible en español en

[LEGO.com/service/buildinginstructions](https://www.lego.com/service/buildinginstructions)







## Taj Mahal – The History

Located on the southern bank of the river Yamuna in the Indian city of Agra, the Taj Mahal is one of the great monuments of the world and a symbol of eternal love. The iconic ivory-white marble mausoleum is finally recreated here in LEGO® Architecture scale.

The Taj Mahal was commissioned in 1632 by the grief-stricken Mughal emperor Shah Jahan (1592–1666) to house the tomb of his beloved third wife, Mumtaz Mahal (1593–1631). Over 20,000 laborers and 1,000 elephants were involved in the ambitious construction, which took 22 years to complete at an estimated cost of 32 million Indian rupees (the equivalent of over US \$1 billion at the time).

## L'histoire du Taj Mahal

Situé sur la rive sud de la rivière Yamuna dans la ville indienne d'Agra, le Taj Mahal est l'un des grands monuments du monde et un symbole d'amour éternel. L'emblématique mausolée en marbre blanc ivoire a maintenant été recréé à l'échelle LEGO® Architecture.

Le Taj Mahal a été commandé en 1632 par l'endeuillé empereur moghol Shâh Jahân (1592–1666) pour accueillir la tombe de sa troisième épouse bien-aimée, Mumtaz Mahal (1593–1631). Plus de 20 000 ouvriers et 1 000 éléphants ont participé à cette ambitieuse construction, qui a duré 22 ans et coûté environ 32 millions de roupies indiennes (l'équivalent de plus d'un milliard de dollars américains à l'époque).

## La historia del Taj Mahal

Ubicado en la orilla sur del río Yamuna, en la ciudad india de Agra, el Taj Mahal es uno de los grandes monumentos del mundo y un símbolo de amor eterno. El inconfundible mausoleo de mármol blanco marfil llega por fin a tus manos, esta vez a escala LEGO® Architecture.

El Taj Mahal fue encargado en 1632 por el afligido emperador mogol Shah Jahan (1592–1666) para alojar la tumba de la que fuera su amada tercera esposa, Mumtaz Mahal (1593–1631). Más de 20.000 trabajadores y 1000 elefantes participaron en la ambiciosa obra, que duró 22 años y tuvo un costo estimado de 32 millones de rupias indias (el equivalente a más de 1000 millones de dólares estadounidenses en ese momento).



Chamber of Mughal emperor Shah Jahan and Mumtaz Mahal  
Chambre de l'empereur moghol Shâh Jahân et de Mumtaz Mahal  
Cámara del emperador mogol Shah Jahan y Mumtaz Mahal



Rok Zgalin Kobe, Senior Designer at the LEGO Group.  
 Rok Zgalin Kobe, concepteur principal chez le Groupe LEGO.  
 Rok Zgalin Kobe, diseñador sénior de The LEGO Group.

## The Design Team

As both a trained architect and a LEGO® designer, Rok Zgalin Kobe has always been fascinated by the Taj Mahal and his goal was to recreate the details of this intricate monument. "The story of the Taj Mahal is hopefully mirrored here in LEGO bricks: you lift the roof with the onion dome and chattris, the four domed, columned kiosks, to expose the vaulted ceiling of the central chamber. Hidden beneath the removable central chamber is the crypt holding the tombs with the bodies of Mumtaz Mahal and Shah Jahan."

## L'équipe de conception

En tant qu'architecte de formation et concepteur LEGO®, Rok Zgalin Kobe a toujours été fasciné par le Taj Mahal et son but était de recréer les moindres détails de ce monument complexe. « L'histoire du Taj Mahal est, espérons-le, reflétée ici en briques LEGO : vous soulevez le toit avec le dôme en forme d'oignon et les chhatris, les quatre pavillons à colonnes coiffés d'un dôme, pour exposer le plafond voûté de la chambre centrale. Sous la chambre centrale amovible se trouve la crypte accueillant les tombes qui abritent les corps de Mumtaz Mahal et de Shâh Jahân. »

A golden LEGO® ski pole represents the ornament at the apex of the dome of the Taj Mahal.

Un bâton de ski LEGO® doré représente l'ornement au sommet du dôme du Taj Mahal.

Un bastón de esquí LEGO® dorado representa el pináculo de la cúpula del Taj Mahal.



The four slender minarets are divided into three parts by balconies created from LEGO gear elements.

Les quatre minces minarets sont divisés en trois parties par des balcons créés à partir d'éléments d'engrenage LEGO.

Los cuatro esbeltos minaretes están divididos en tres secciones mediante balcones creados a partir de engranajes LEGO.



The decorative spires that extend from the edges of the base walls are created using white LEGO ski poles.

Les flèches décoratives qui sortent des bords extérieurs des murs de base sont créées à partir de bâtons de ski LEGO blancs.

Las agujas decorativas que surgen de los bordes de las paredes de la base están recreadas con bastones de esquí LEGO blancos.



## El equipo de diseño

Como arquitecto experto y diseñador de LEGO®, a Rok Zgalin Kobe siempre le ha fascinado el Taj Mahal y su objetivo era recrear los detalles del elaborado monumento. "Espero que el modelo refleje con fidelidad la historia del Taj Mahal mediante bricks LEGO: levantas el techo con la cúpula bulbosa y los chhatris (los cuatro quioscos abovedados con columnas) para descubrir la bóveda de la cámara central. Debajo de la cámara central removible se esconde la cripta que contiene las tumbas con los cuerpos de Mumtaz Mahal y Shah Jahan".







[LEGO.com/brickseparator](https://www.lego.com/brickseparator)



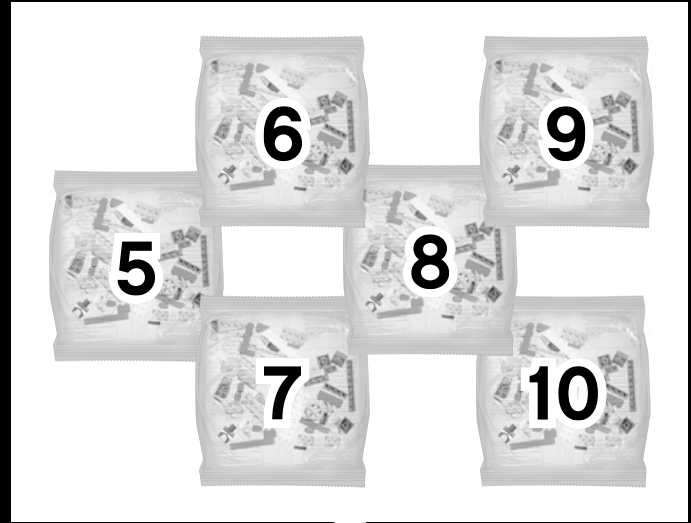
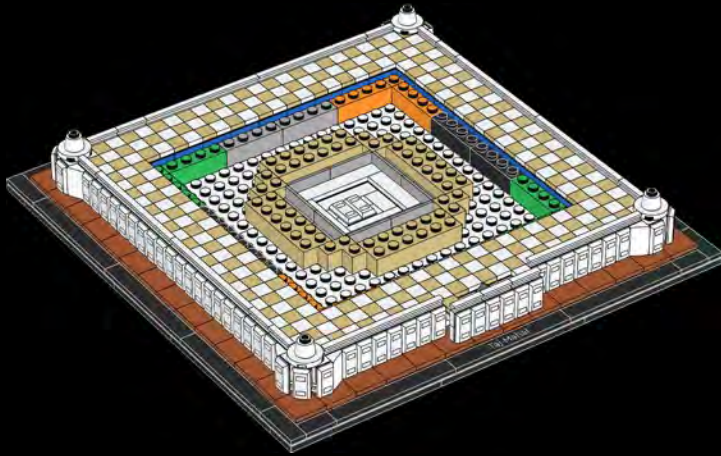

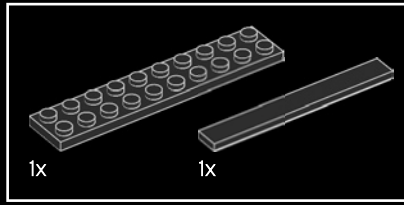
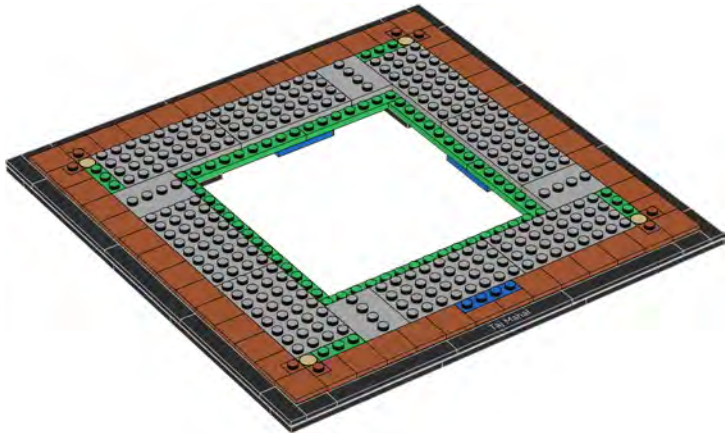
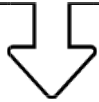

1

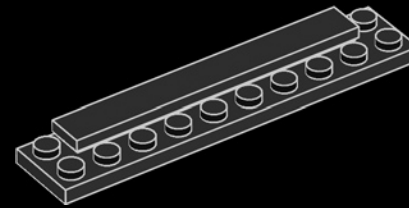



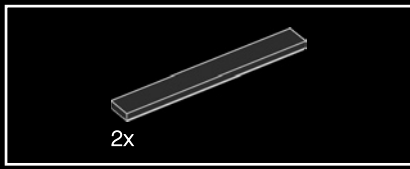

2

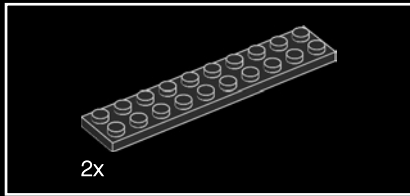
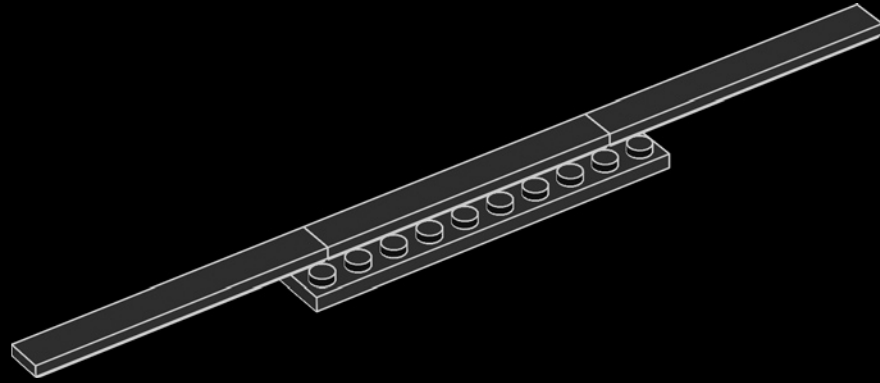

3

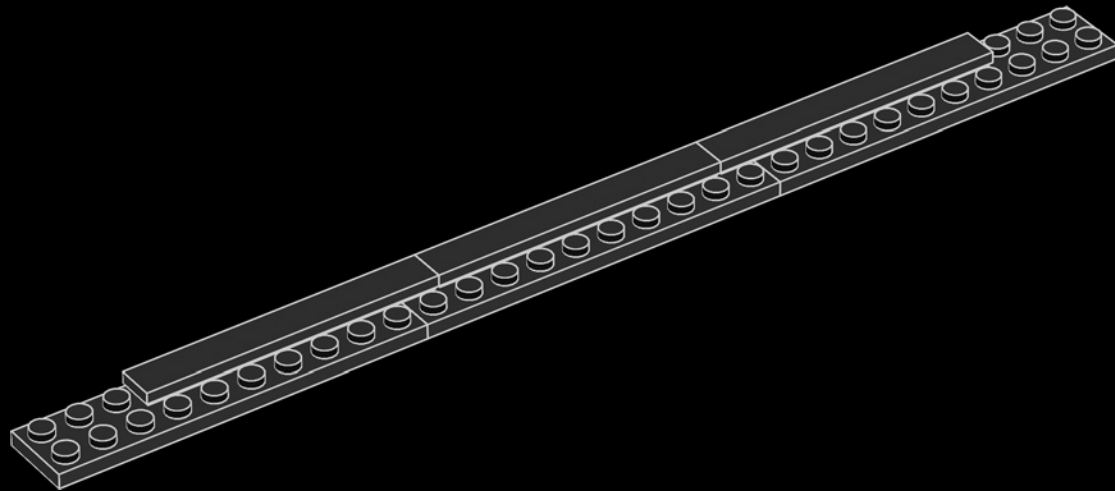

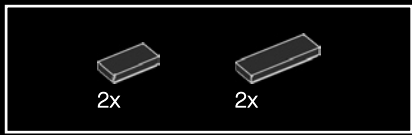

4

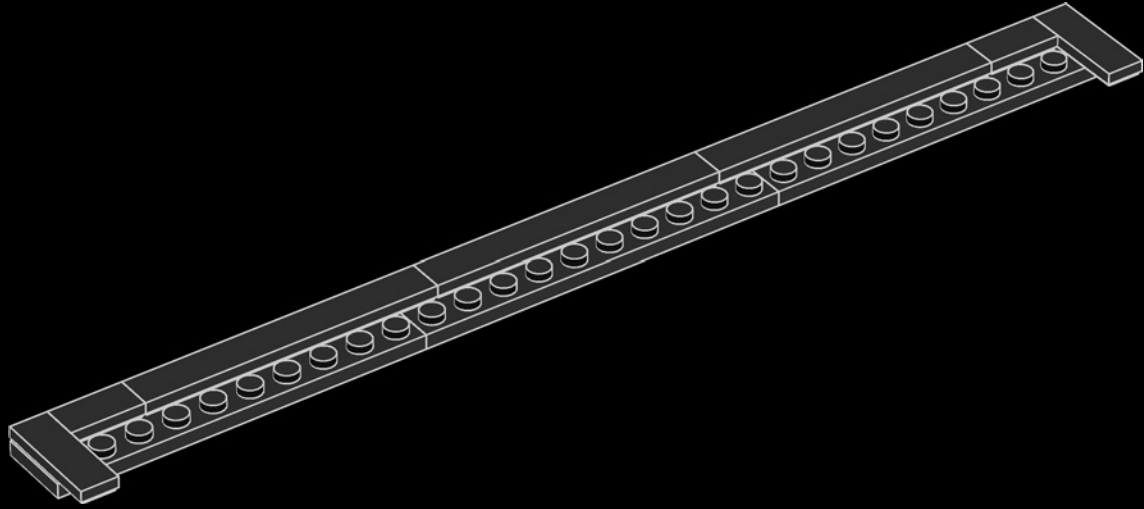



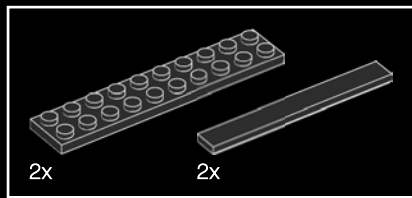

5

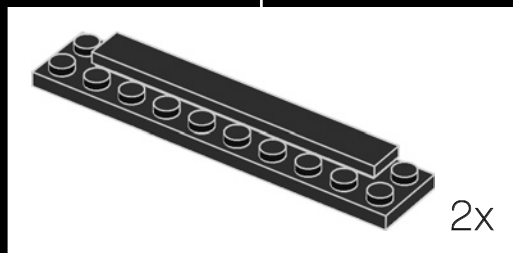
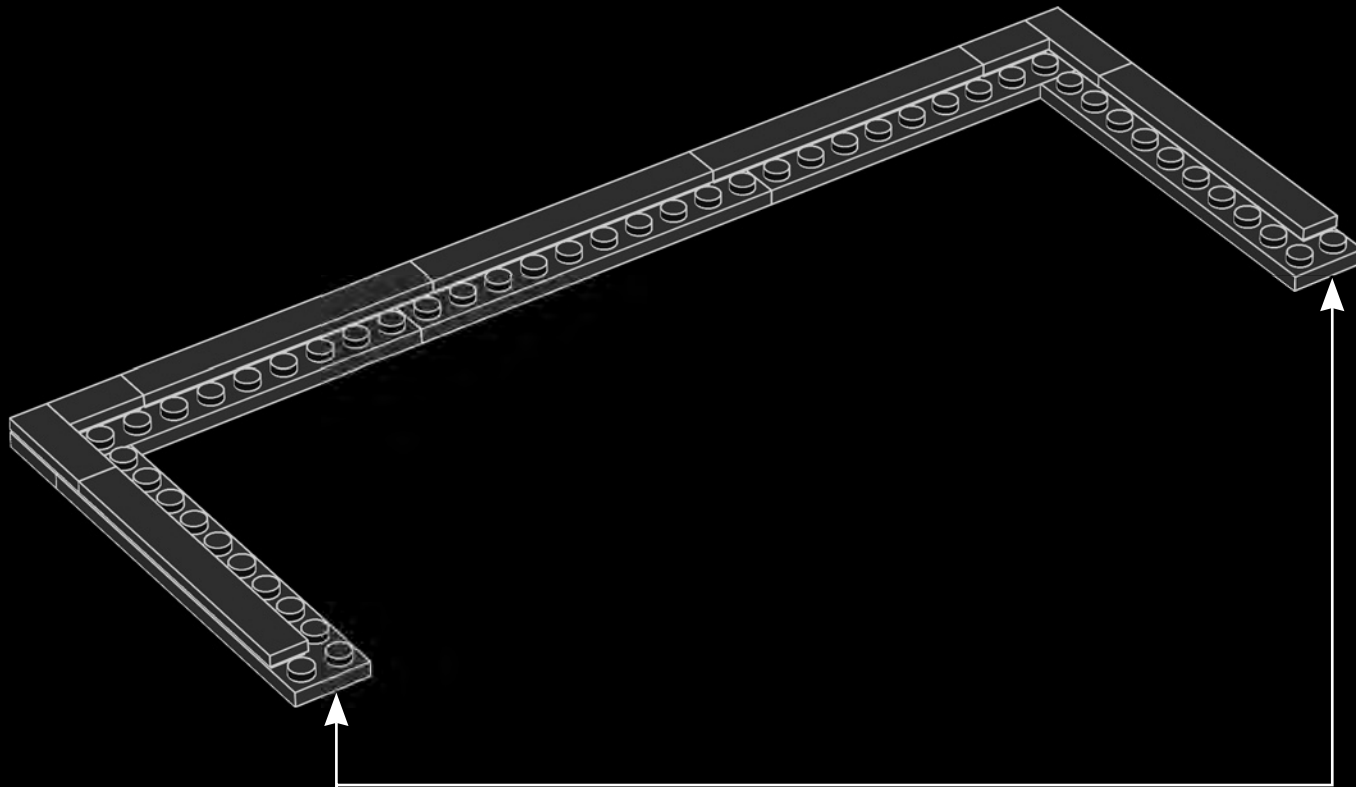

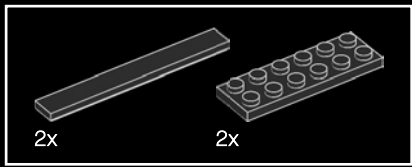

6

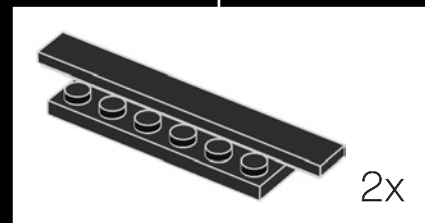
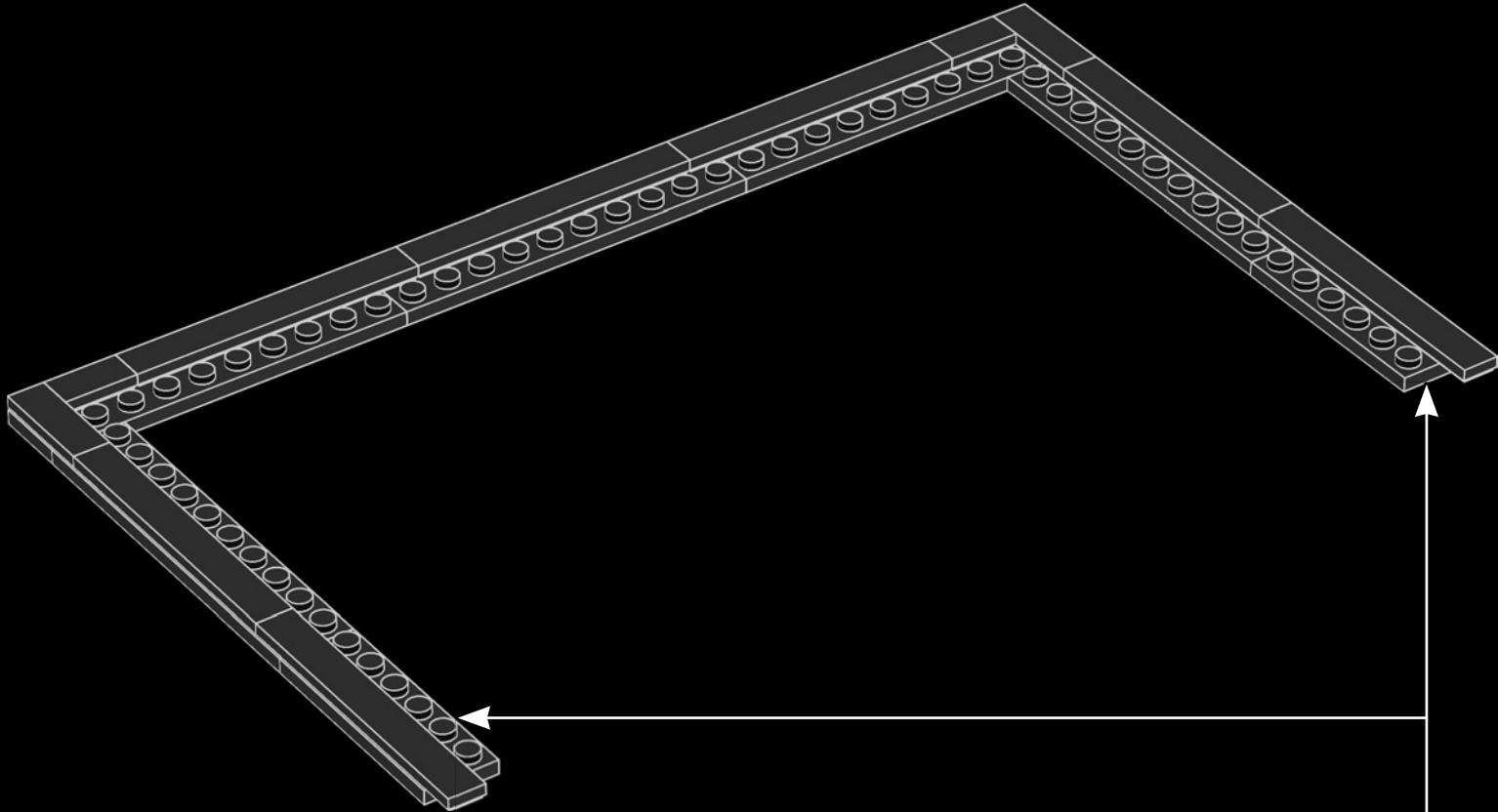

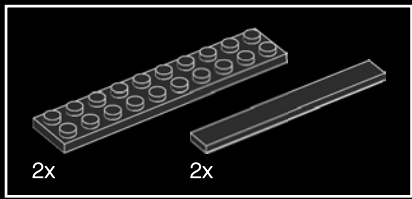

7

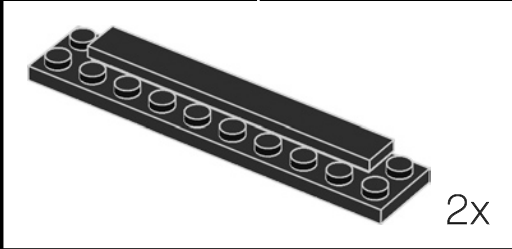
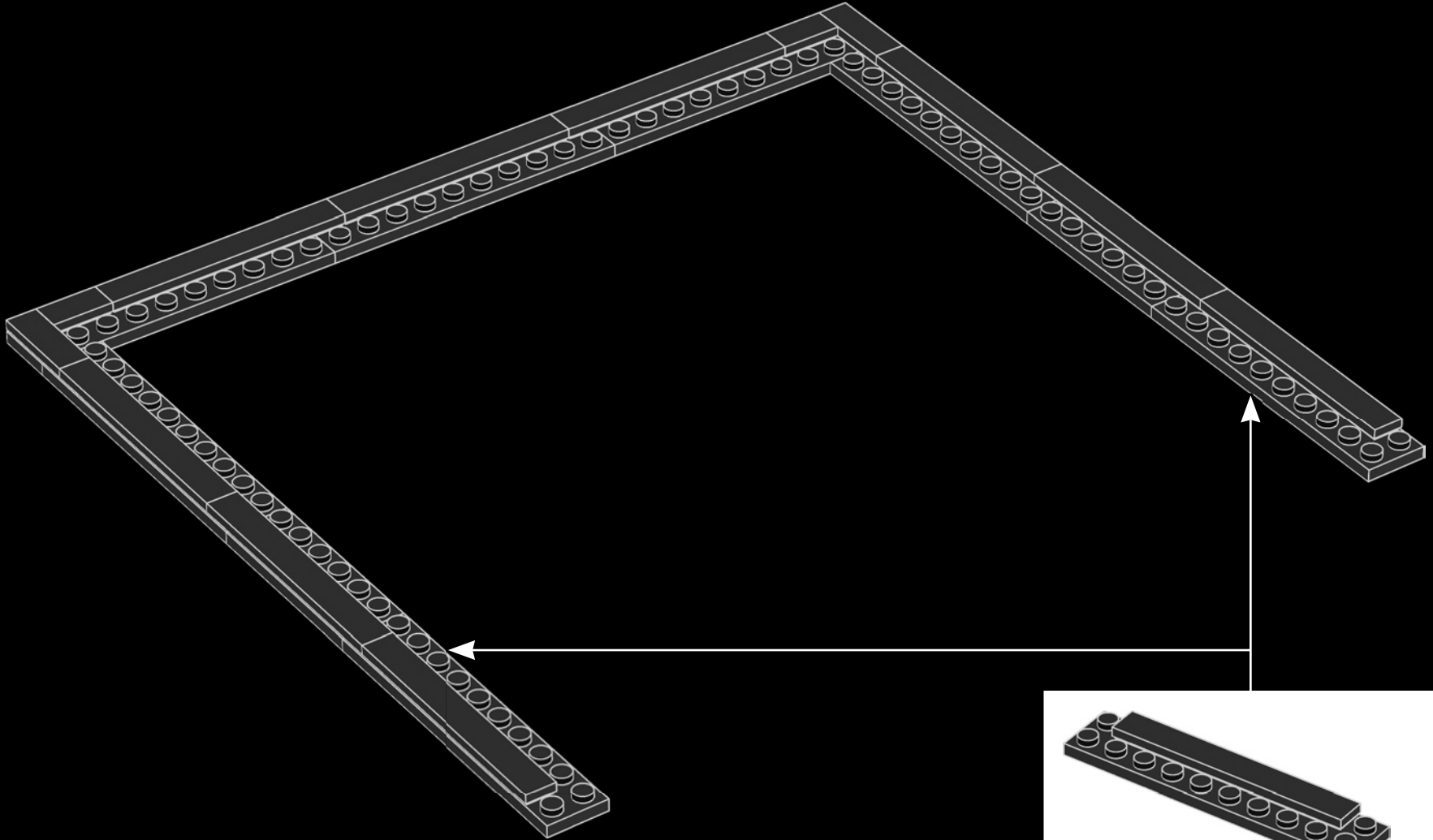



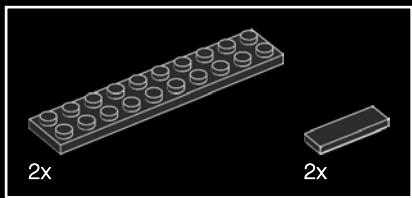

8

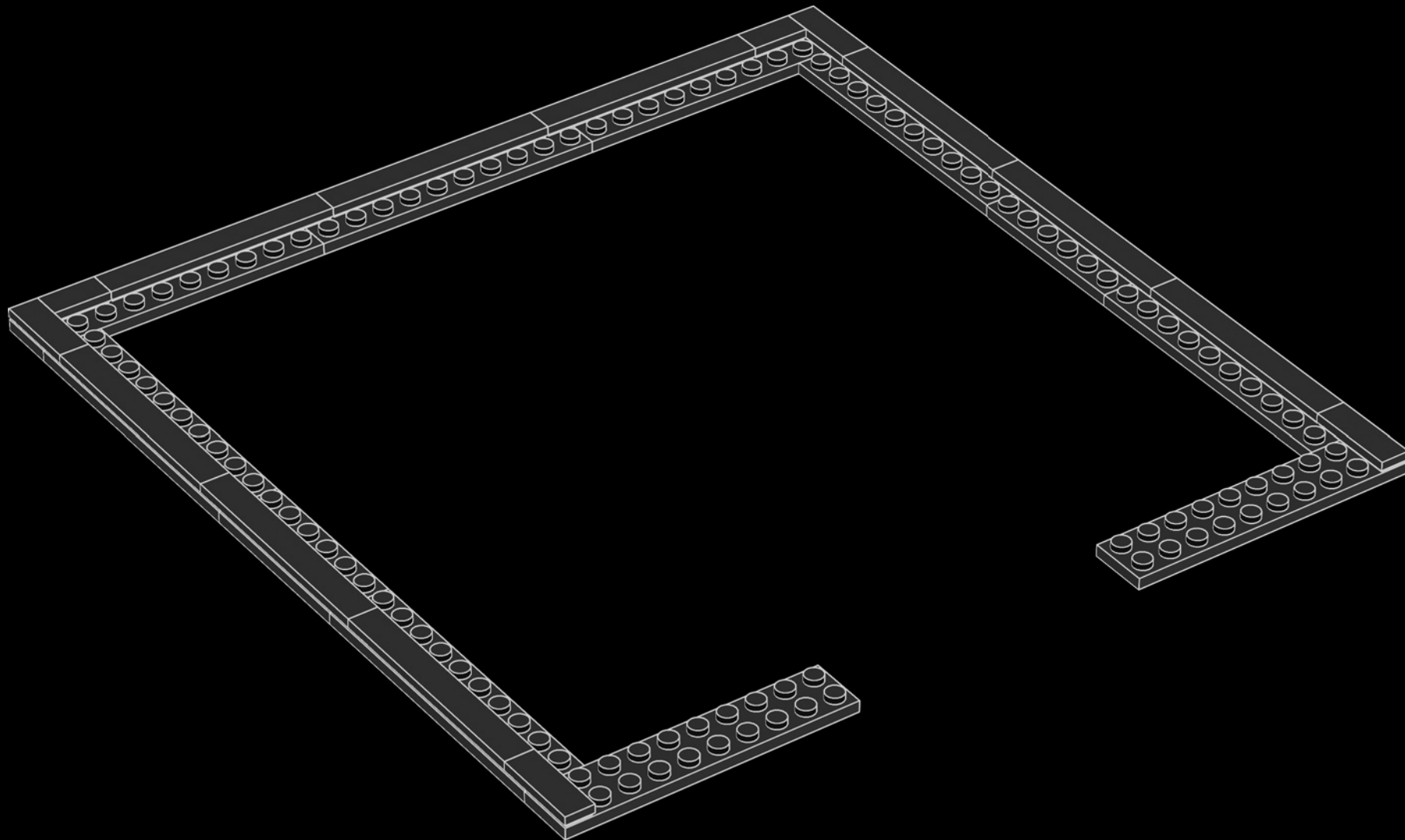

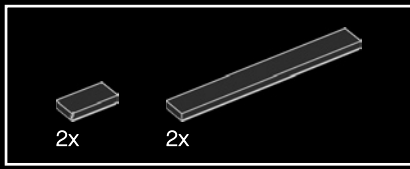

9

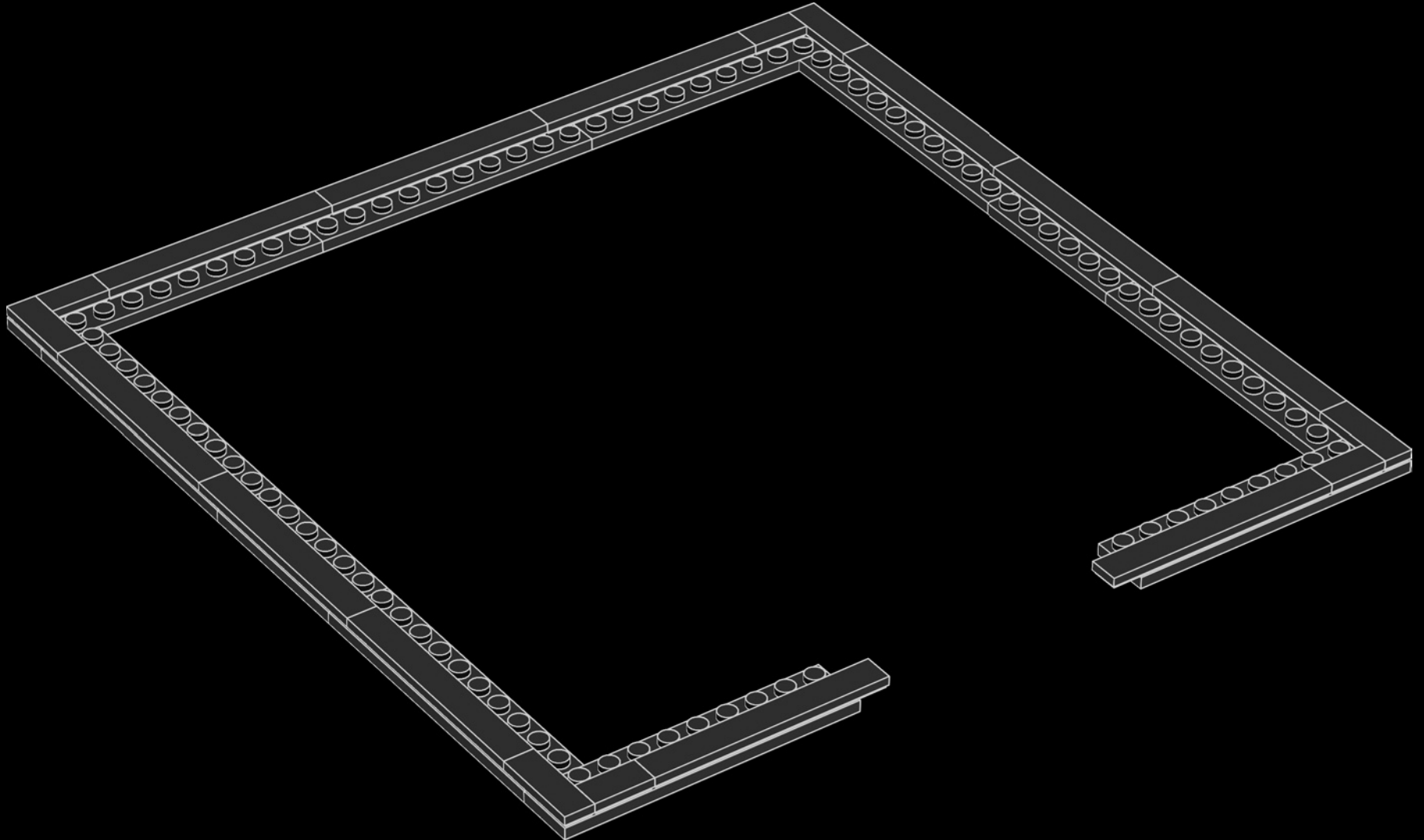

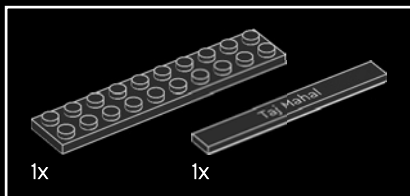

10

During British rule in India, the garden was landscaped to look more like the manicured lawns of England.

Pendant l'Empire britannique des Indes, le jardin a été aménagé pour ressembler davantage aux pelouses soignées de l'Angleterre.

Durante el dominio británico de la India, el jardín se cultivó para que se asemejara a los cuidados parques de Inglaterra.

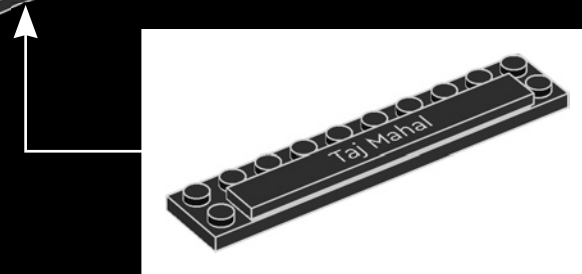
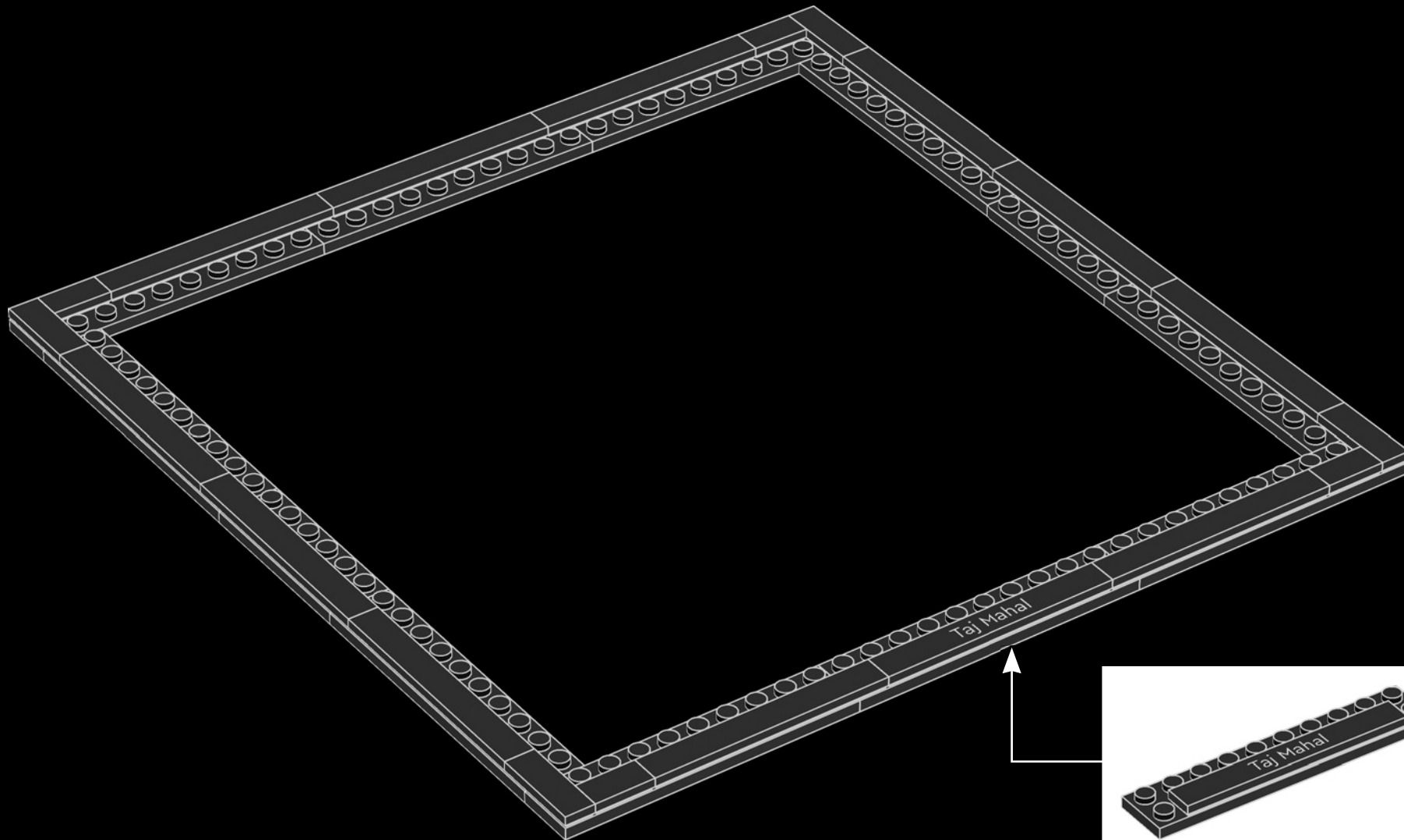
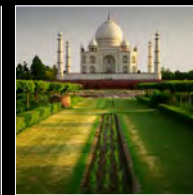



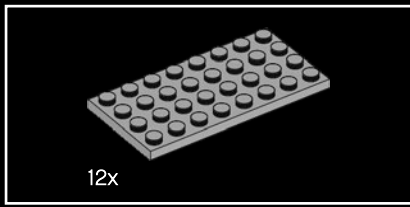

11

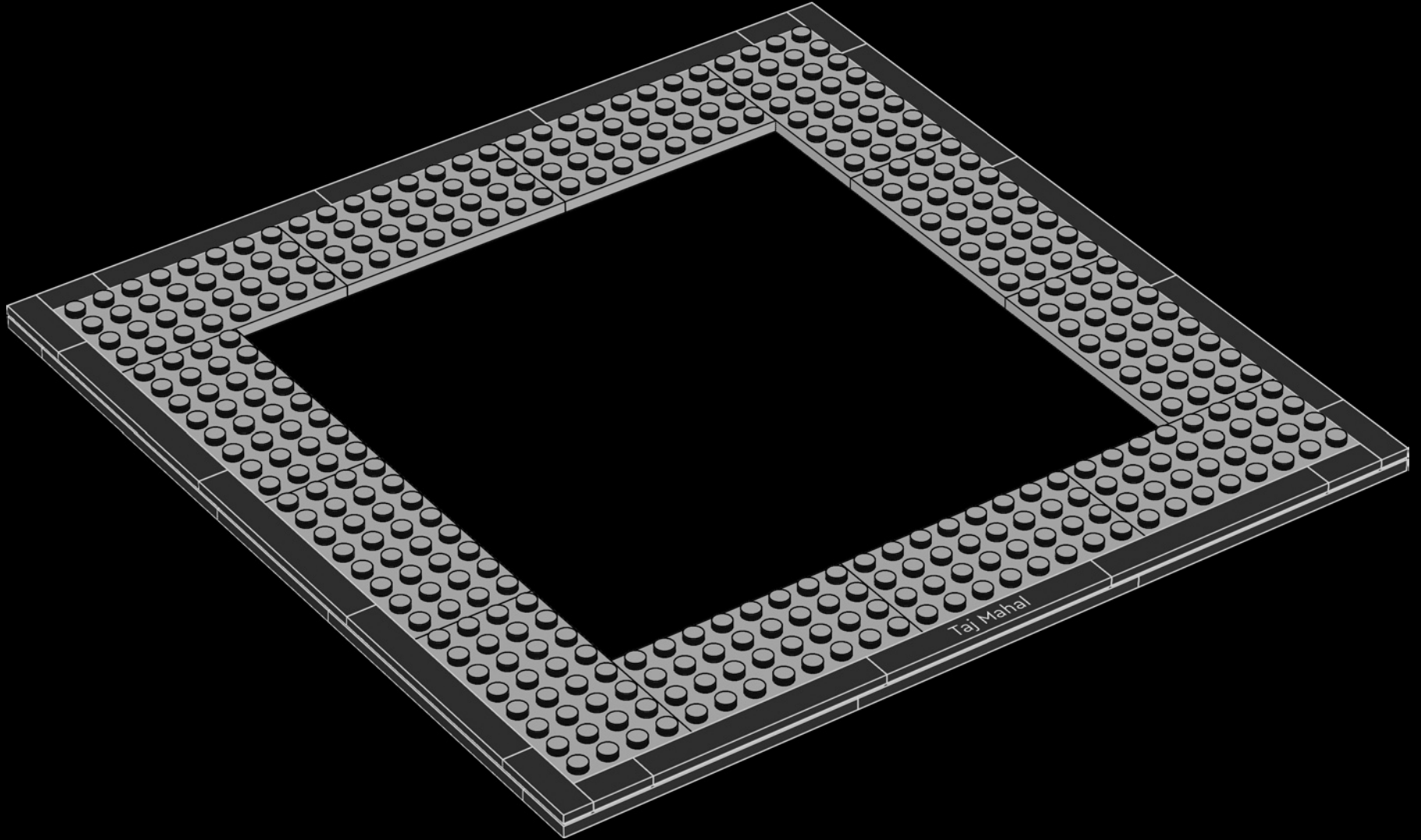

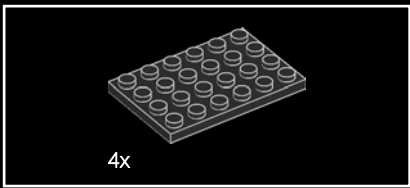

12

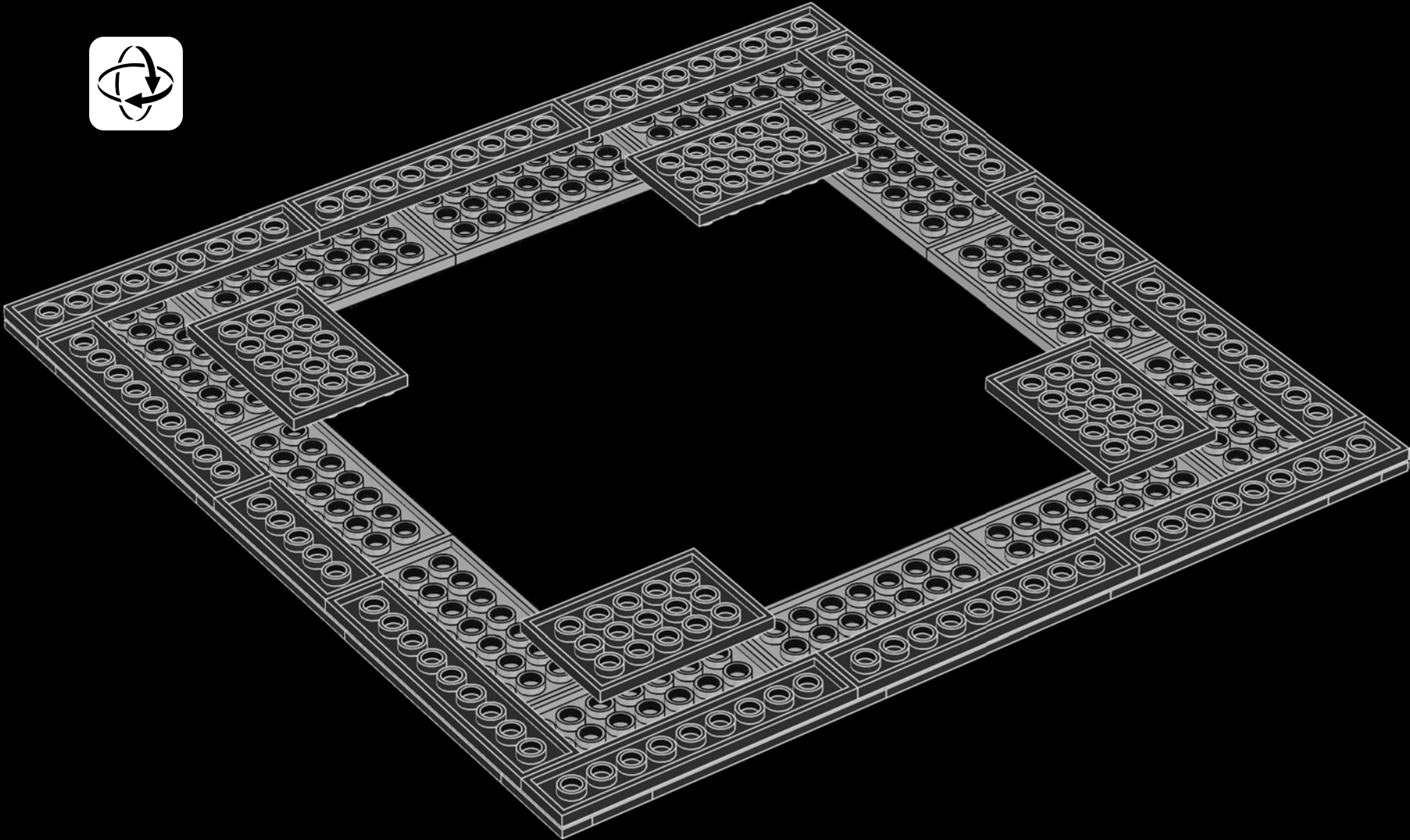

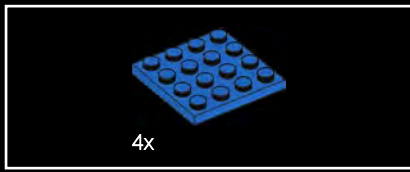

13

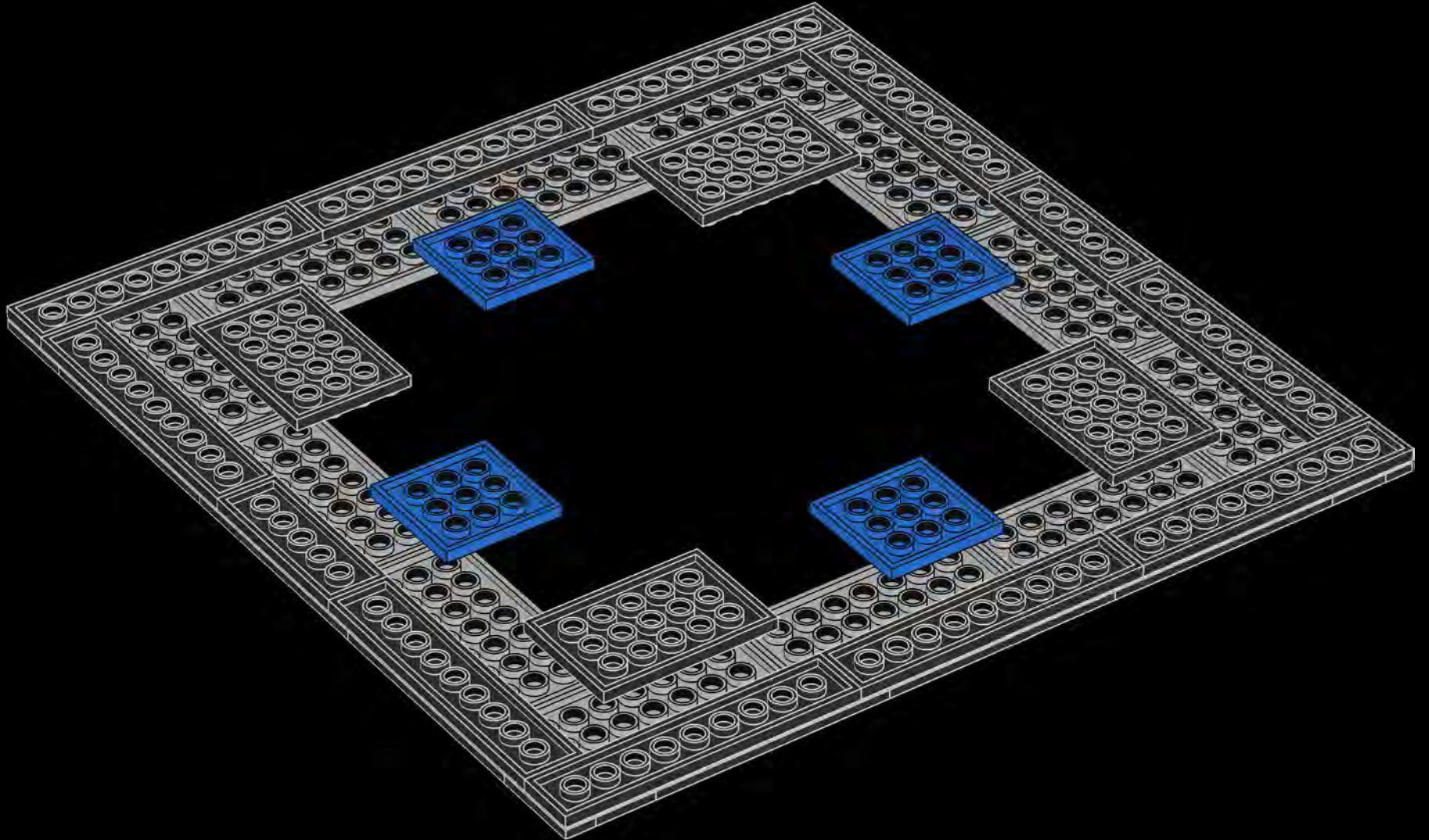



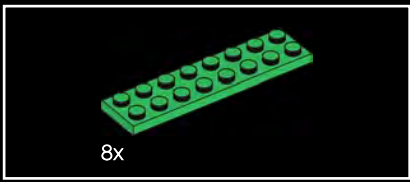

14

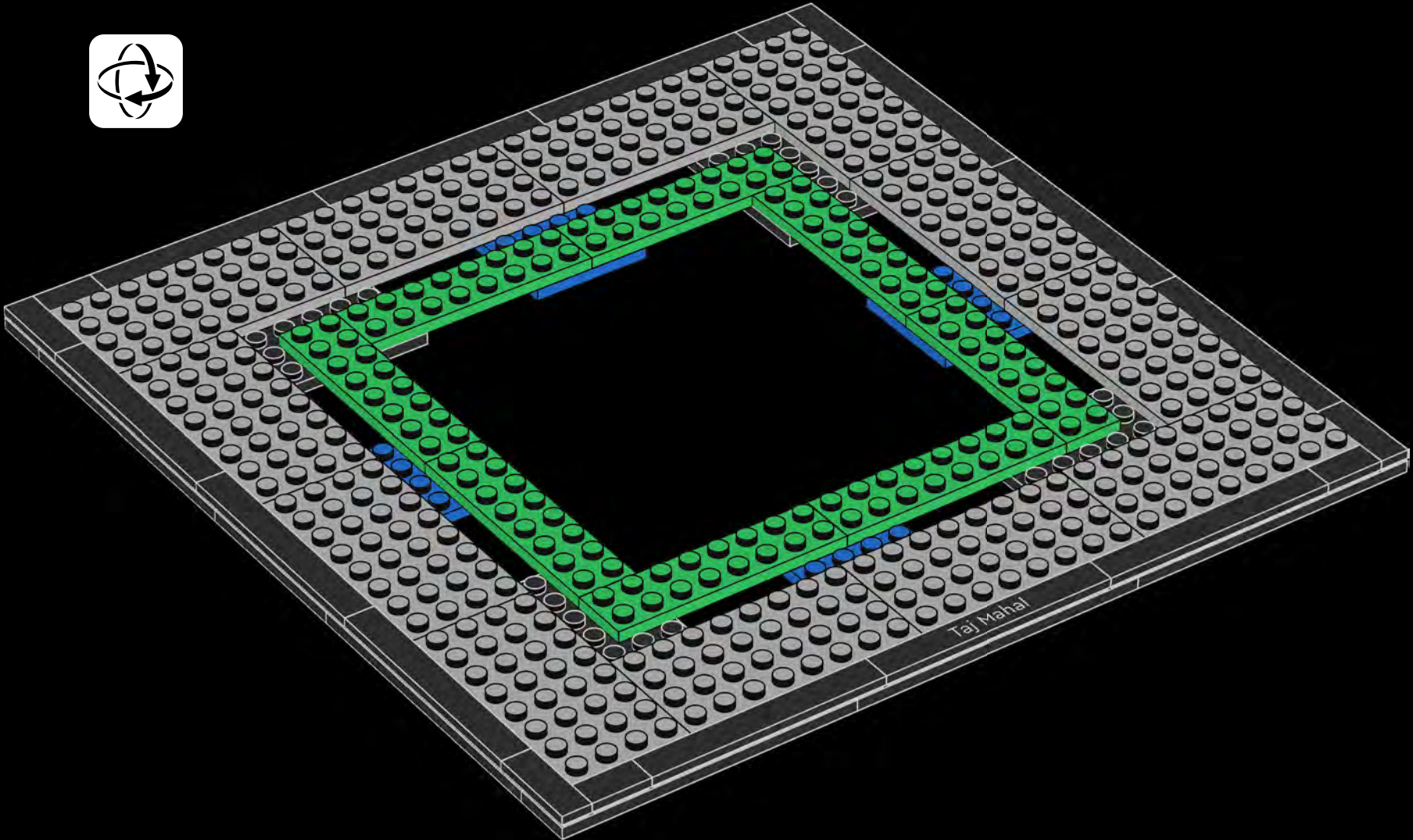

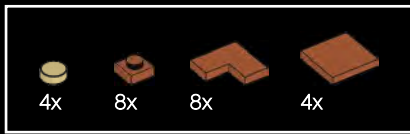

15

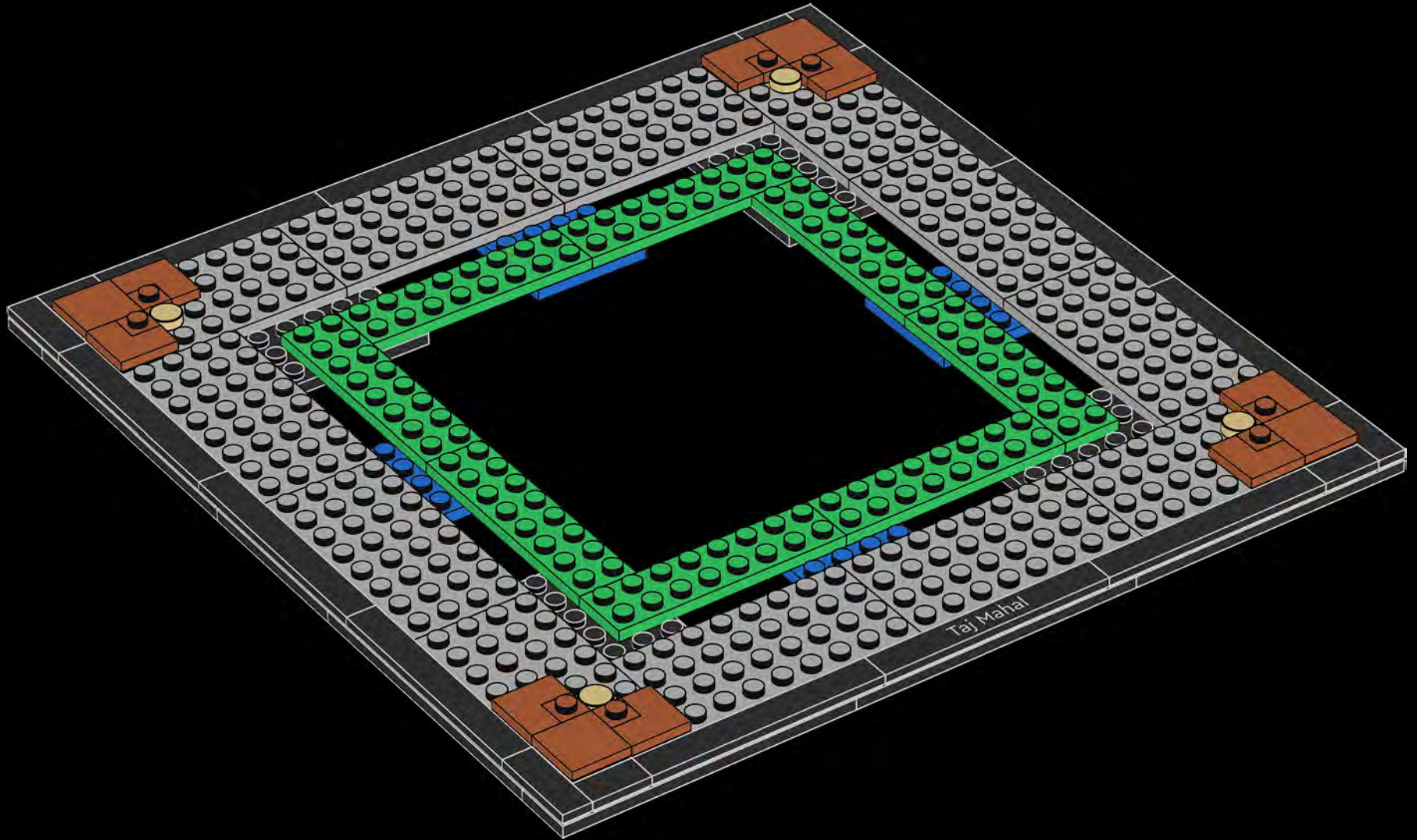





16

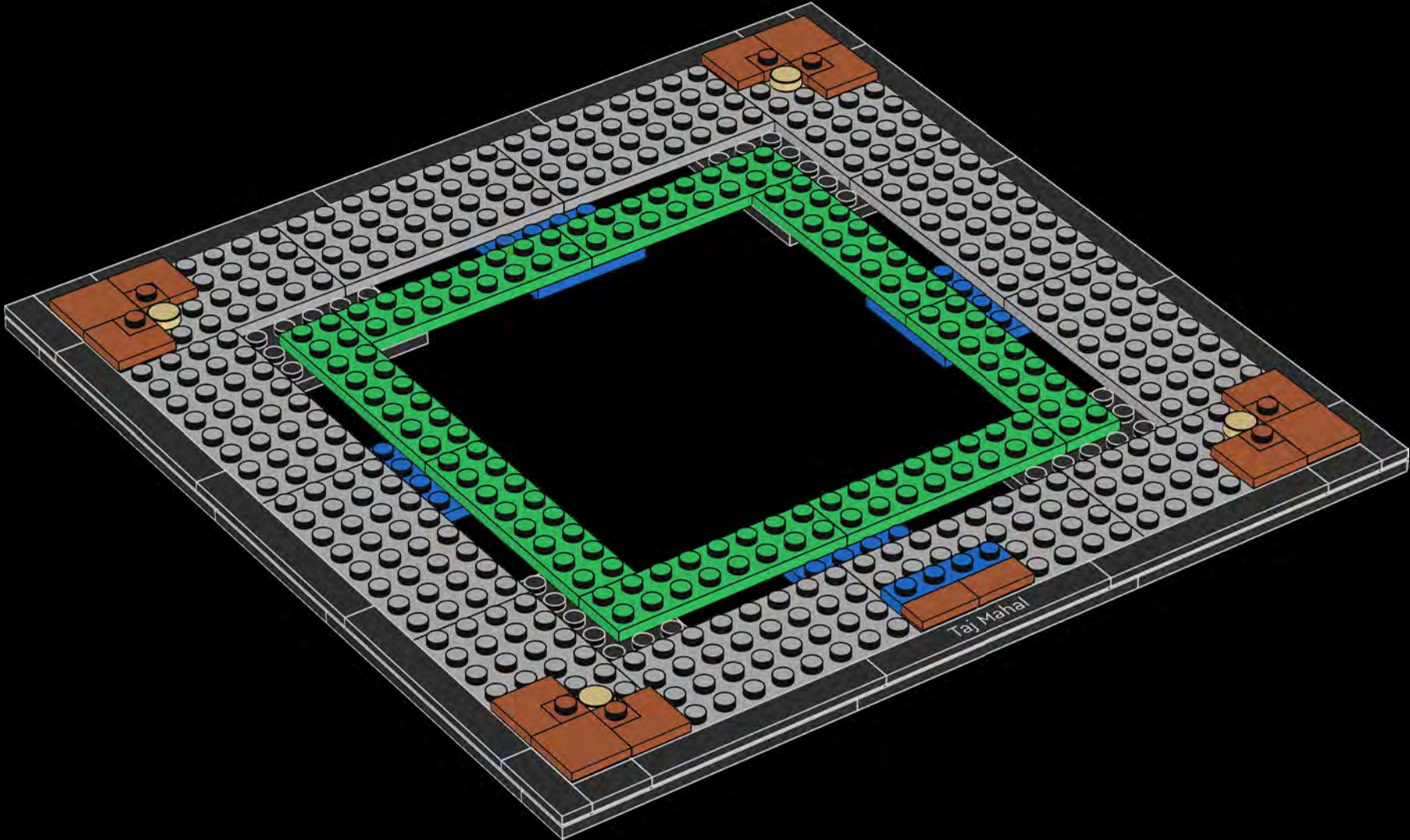



17

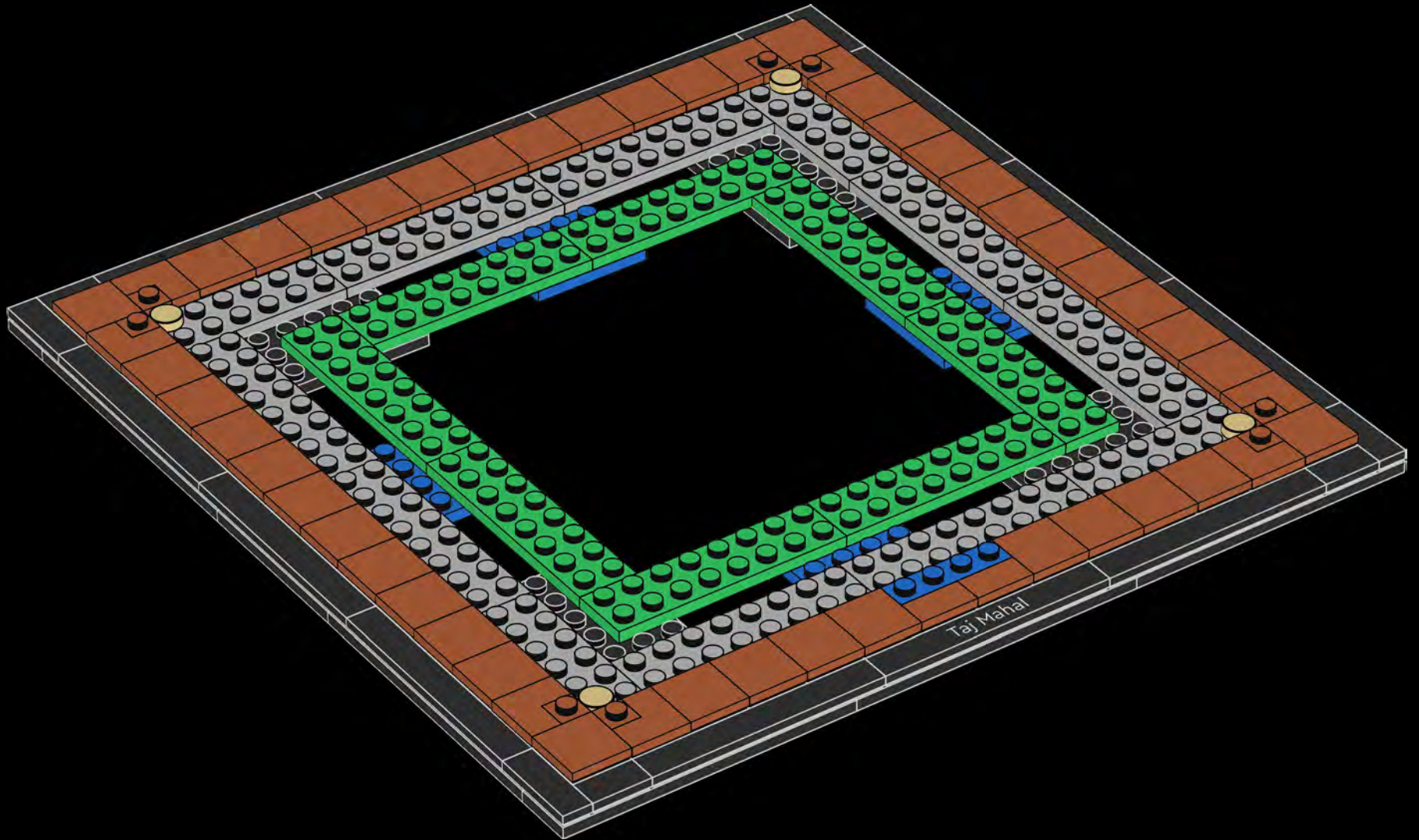



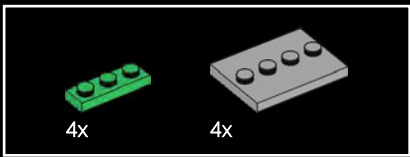

18

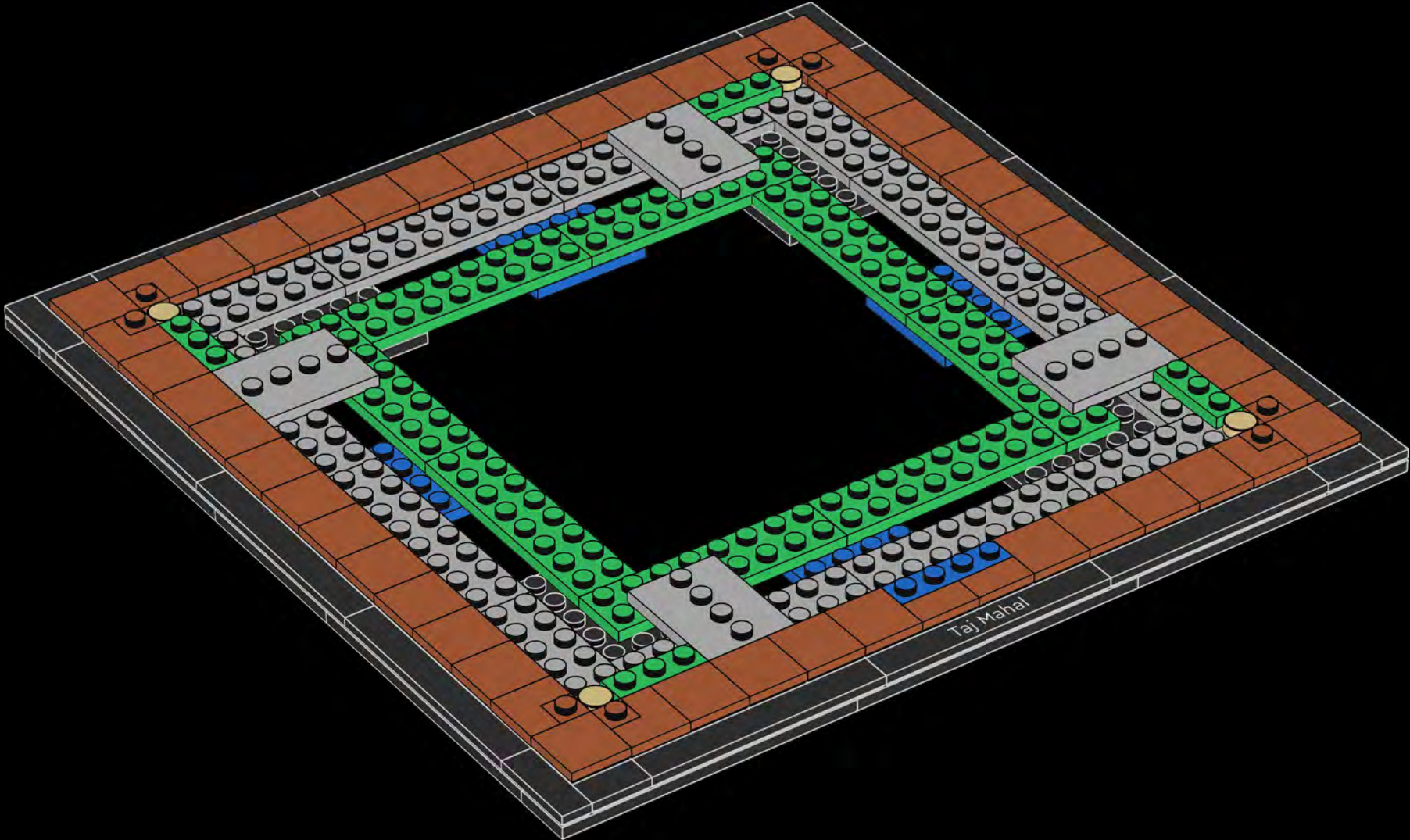

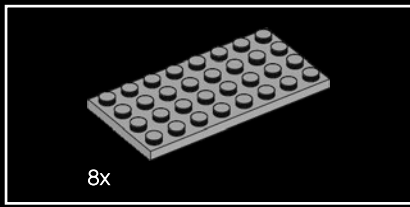

19

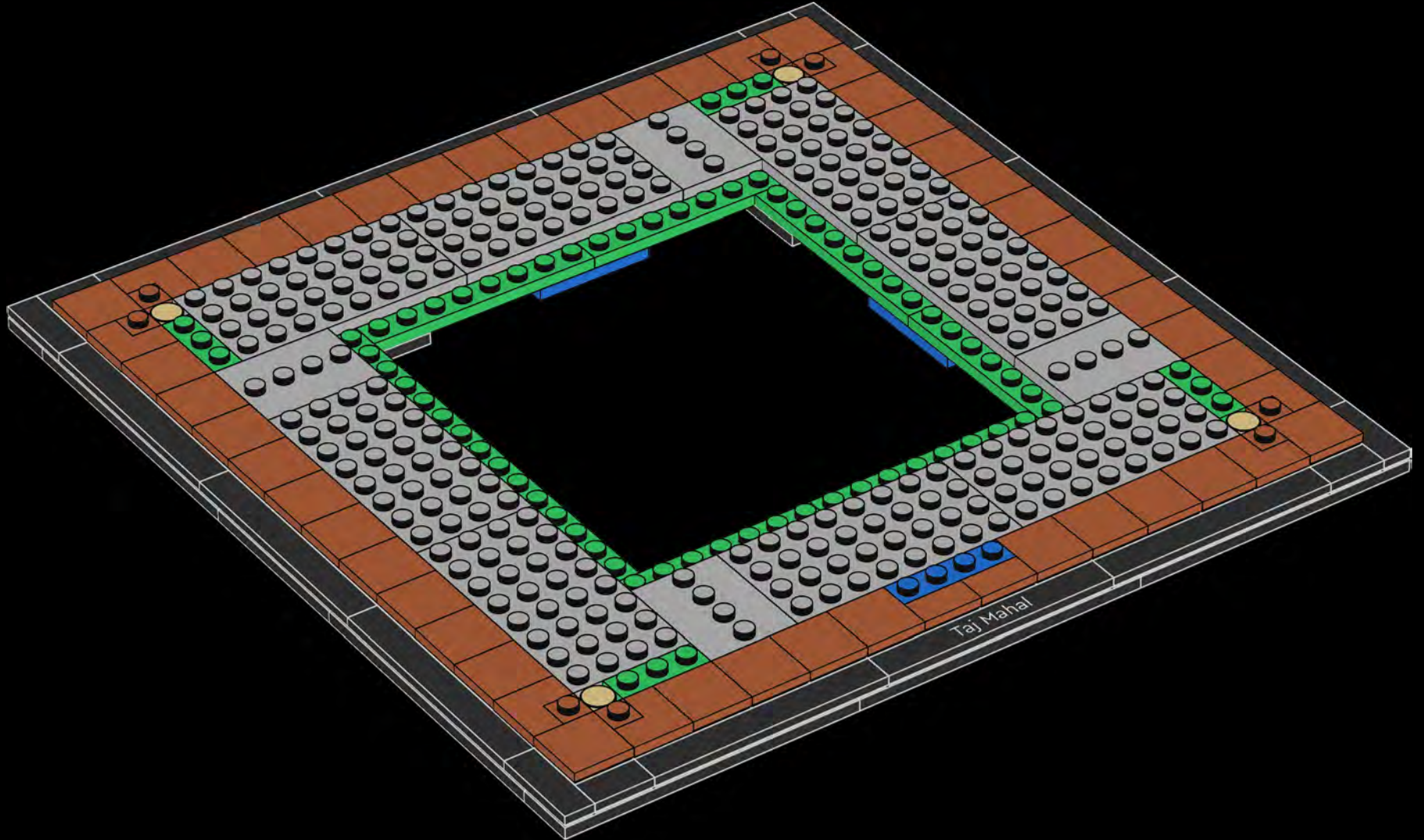

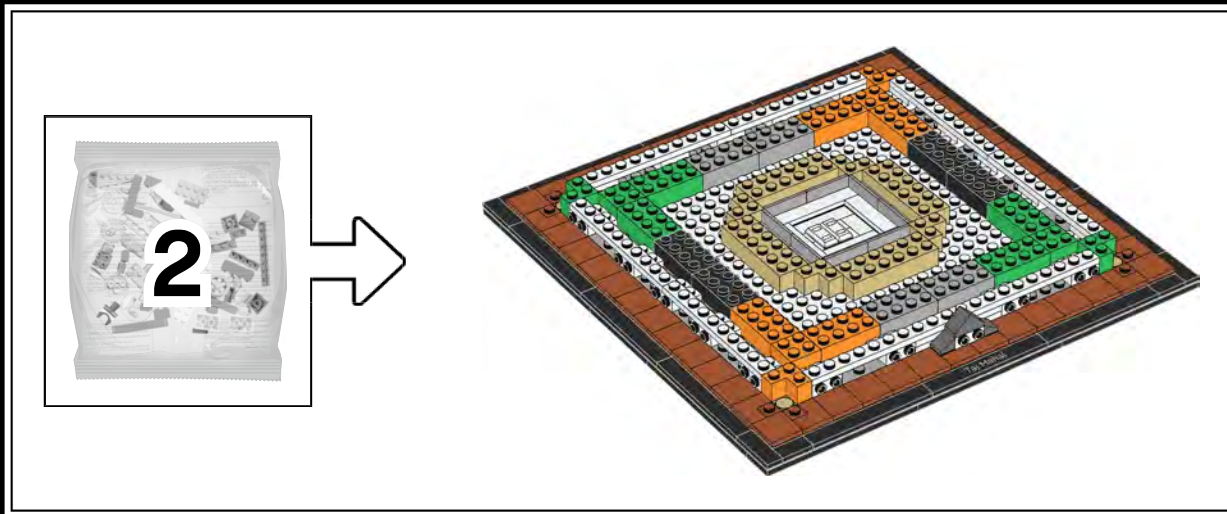



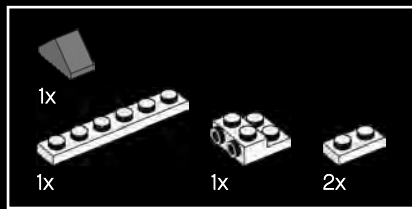

20

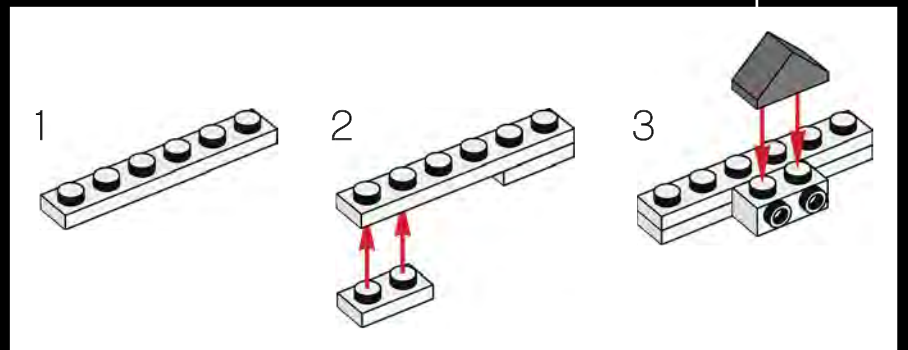
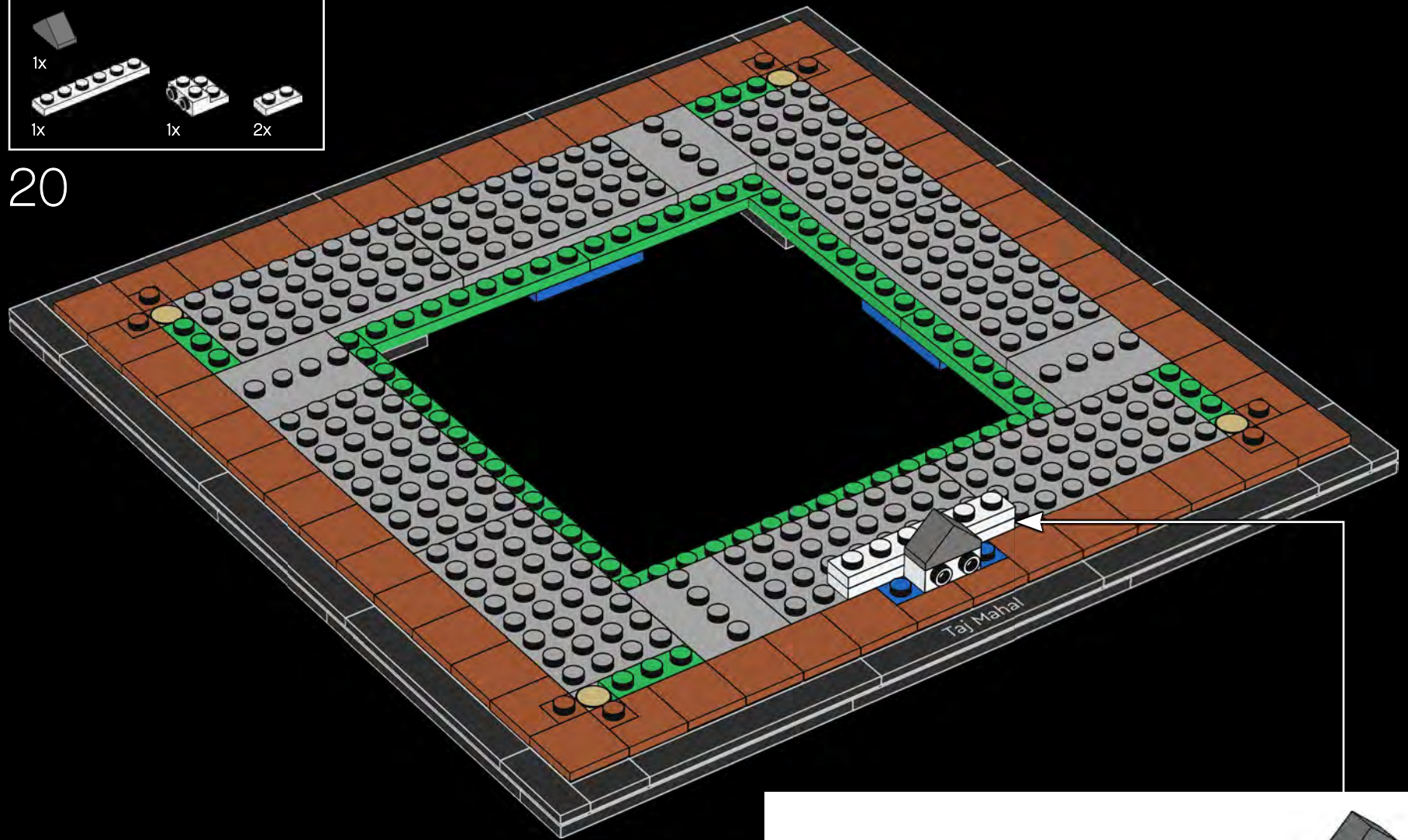





21

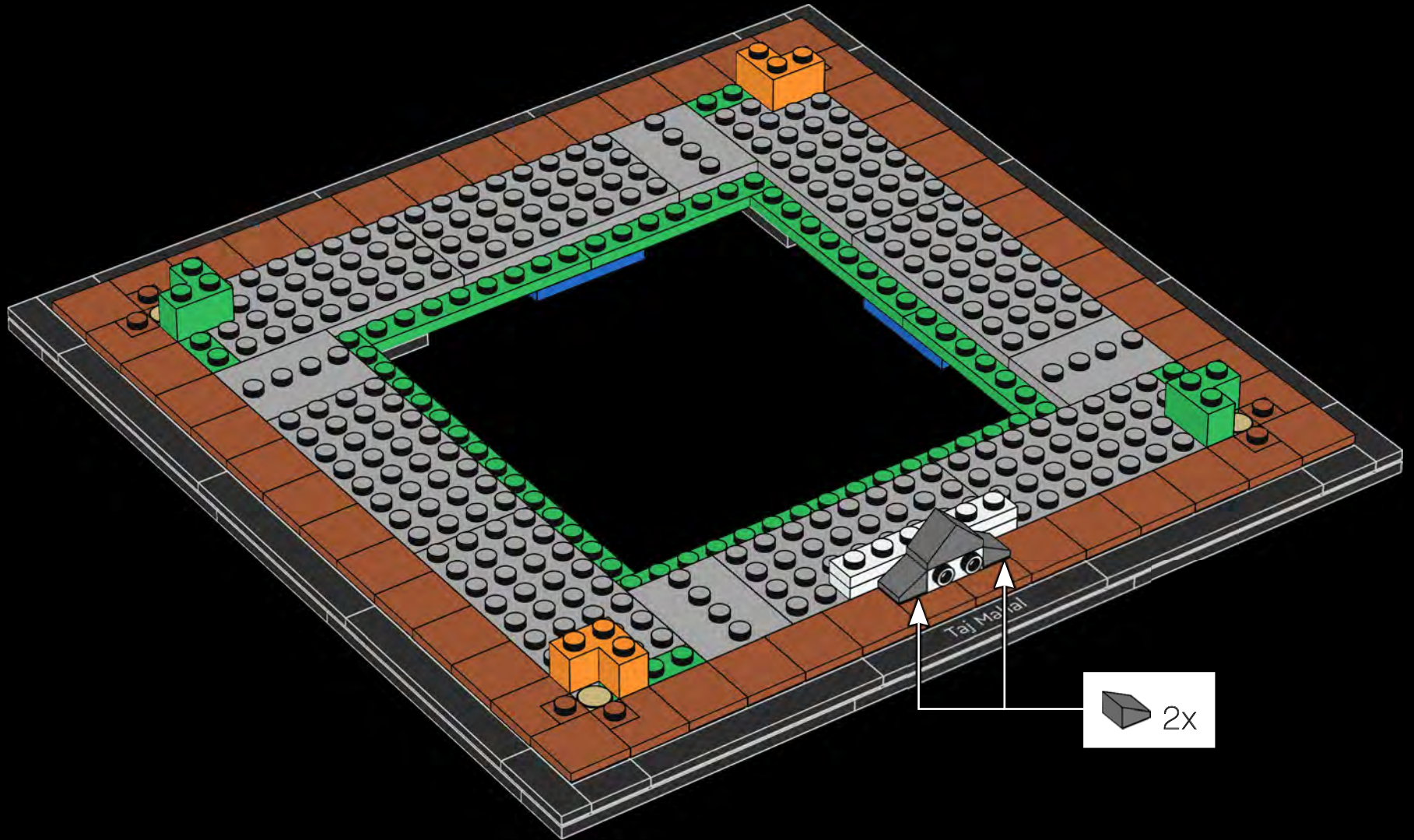



22

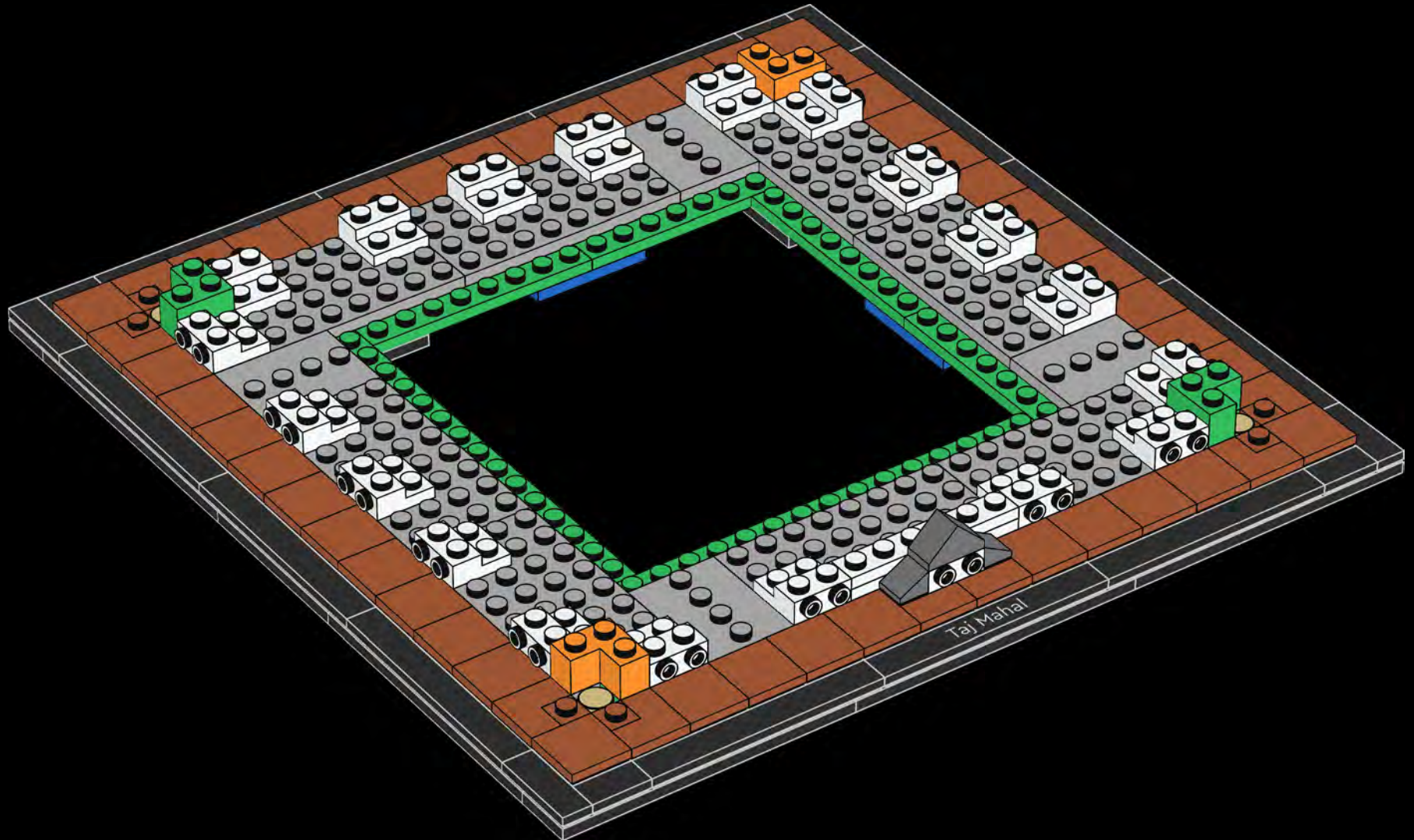



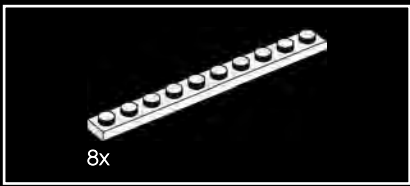

23

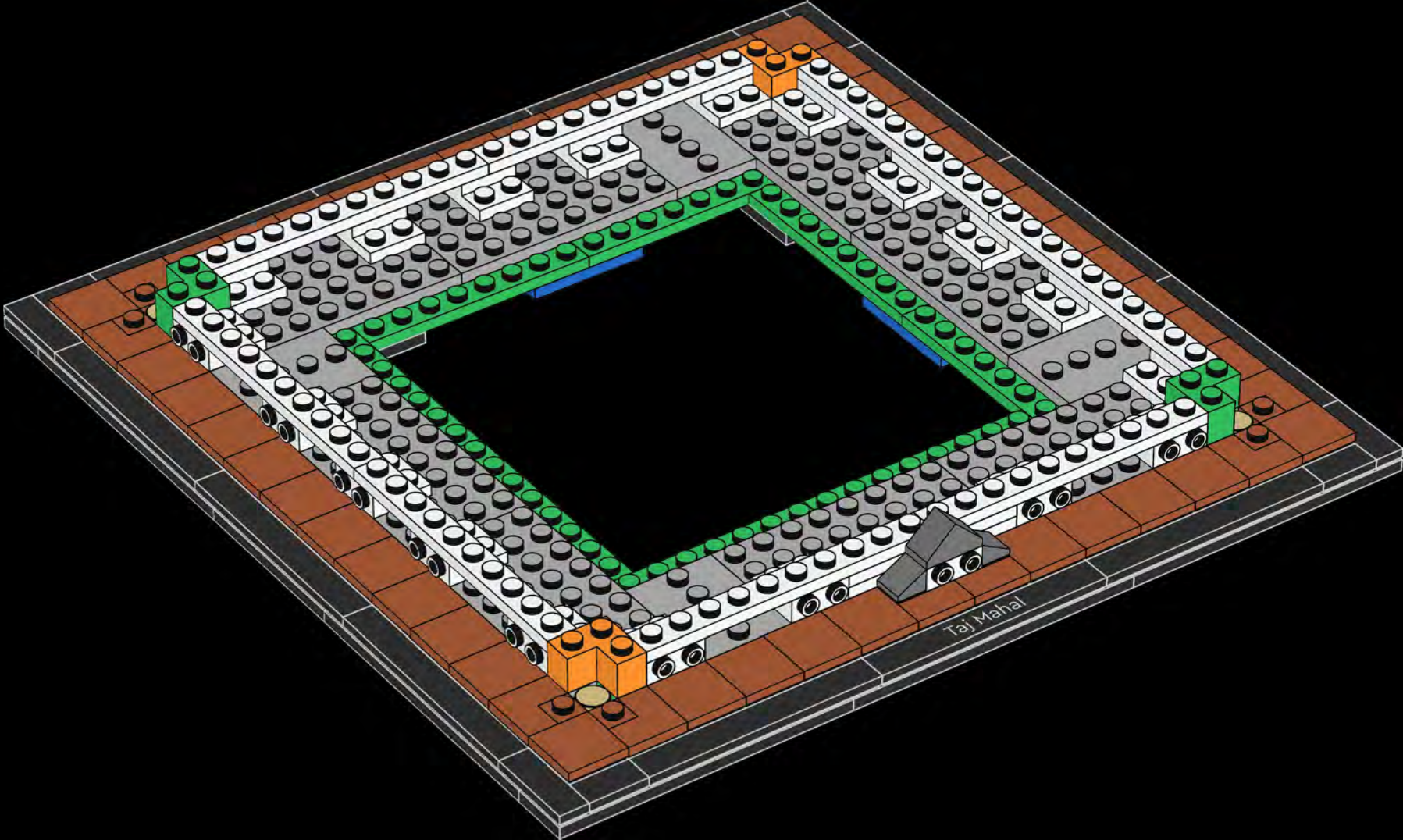

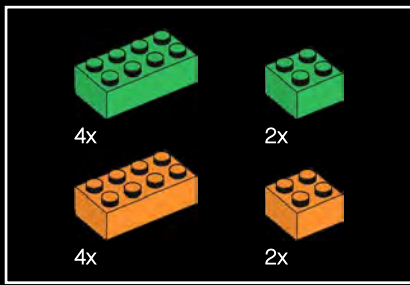

24

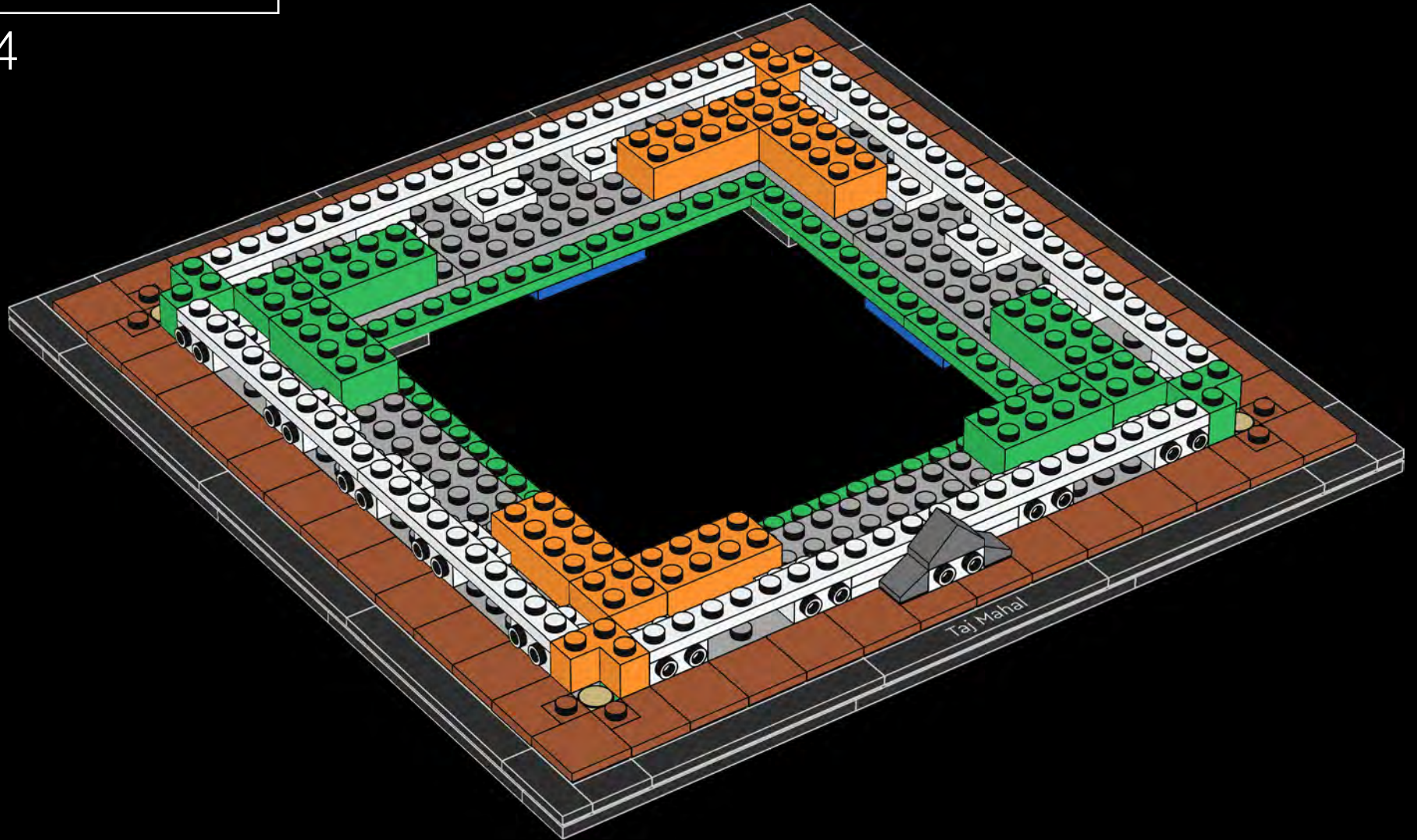



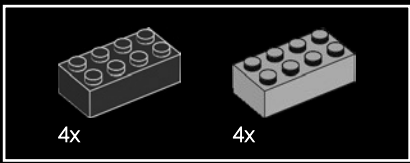

25

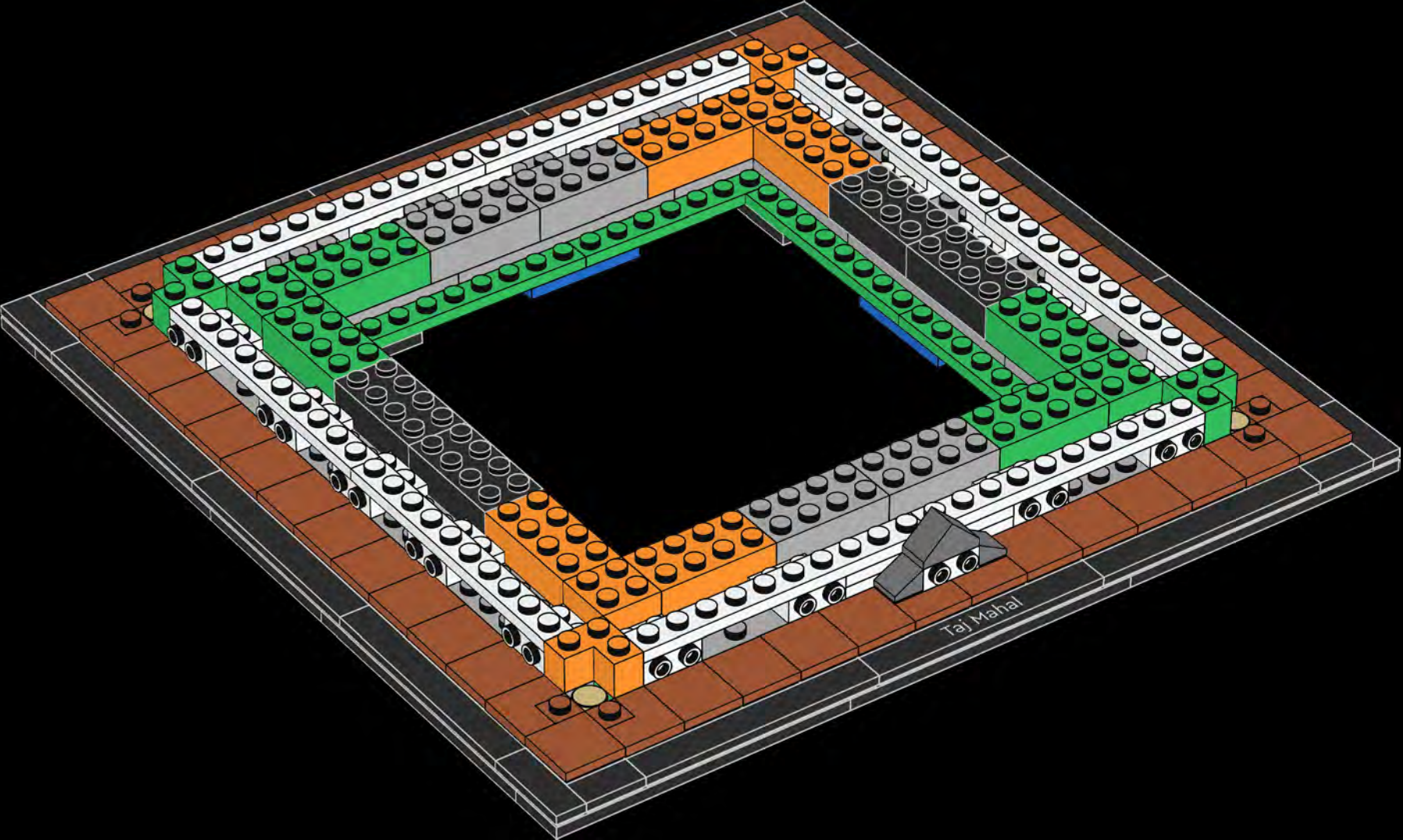

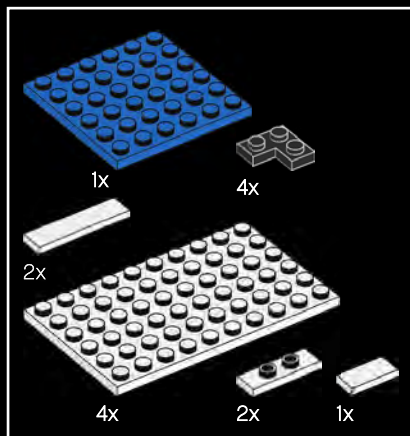

26

Ustad Ahmad Lahauri, generally regarded as the chief architect of the Taj Mahal, was not Indian but a Persian from Iran.

Ustad Ahmad Lahauri, généralement considéré comme l'architecte en chef du Taj Mahal, n'était pas indien, mais bien d'origine perse (Iran).

Ustad Ahmad Lahauri, generalmente considerado el arquitecto principal del Taj Mahal, no era indio, sino persa (de Irán).

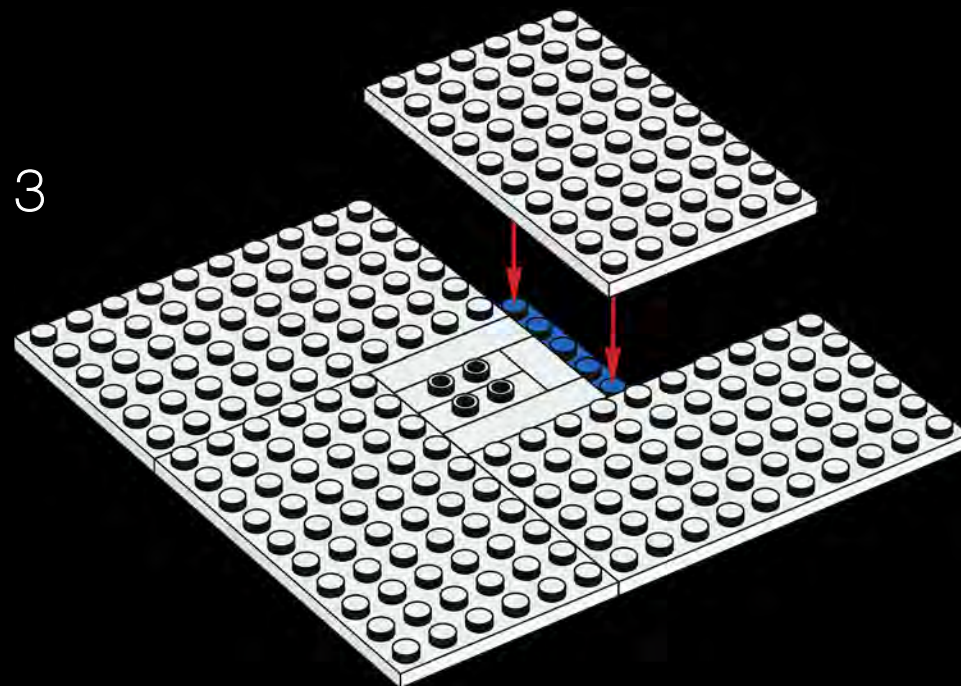
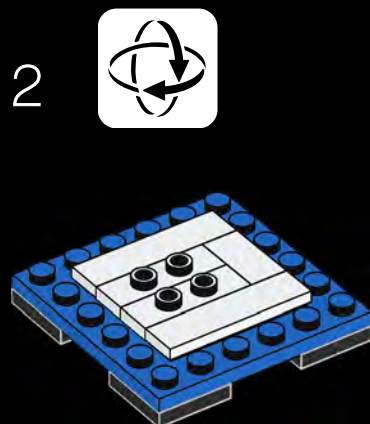
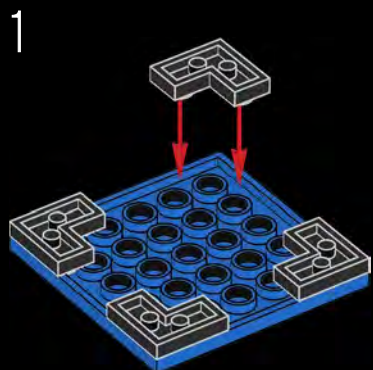



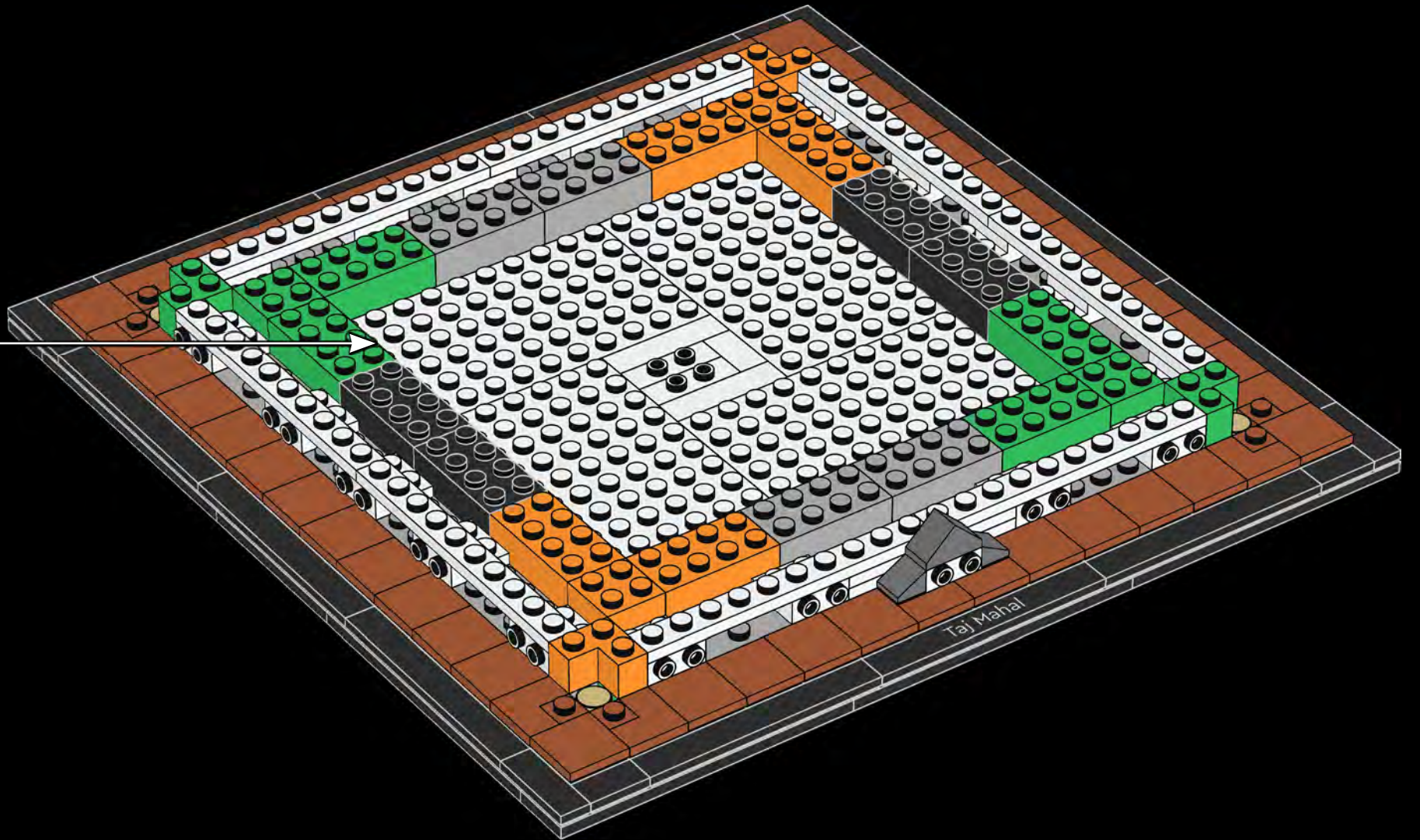



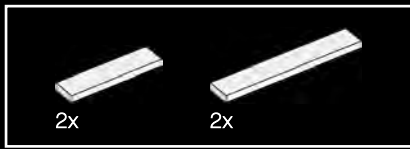

27

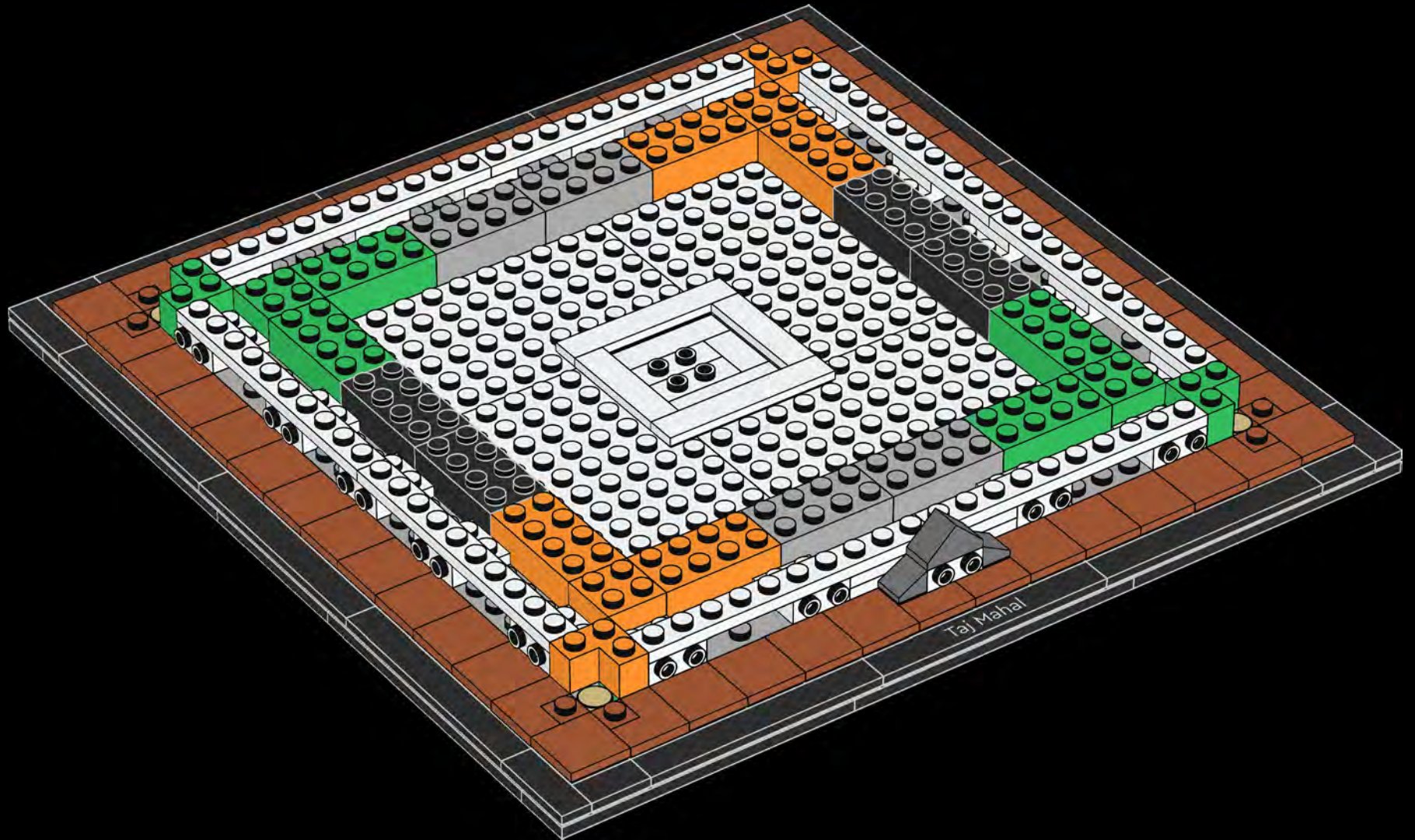



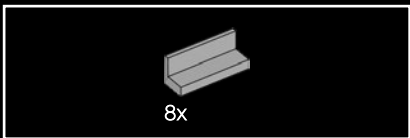

28

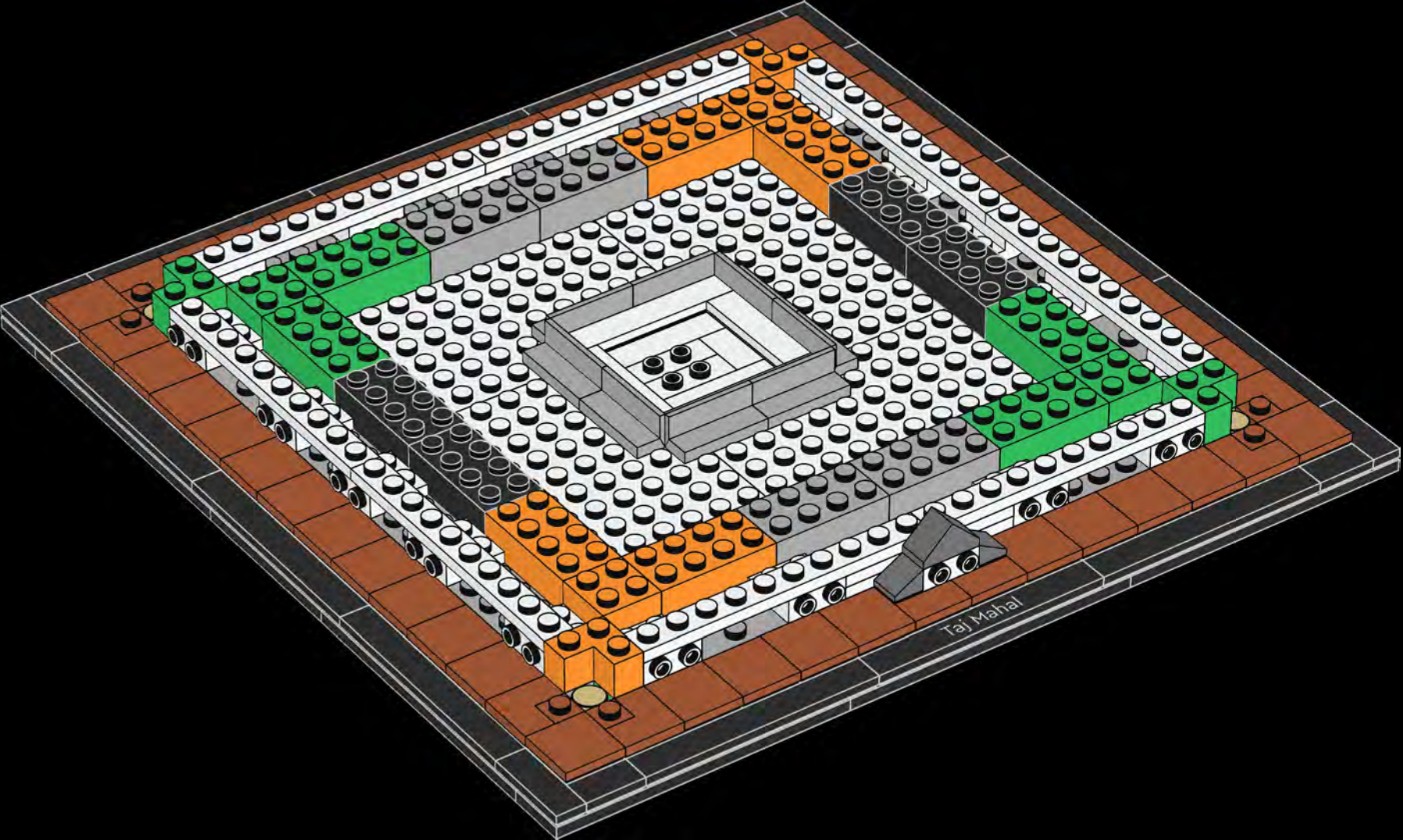



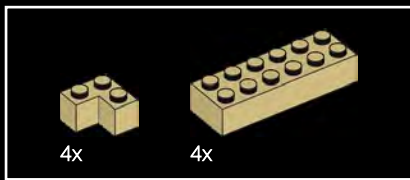

29

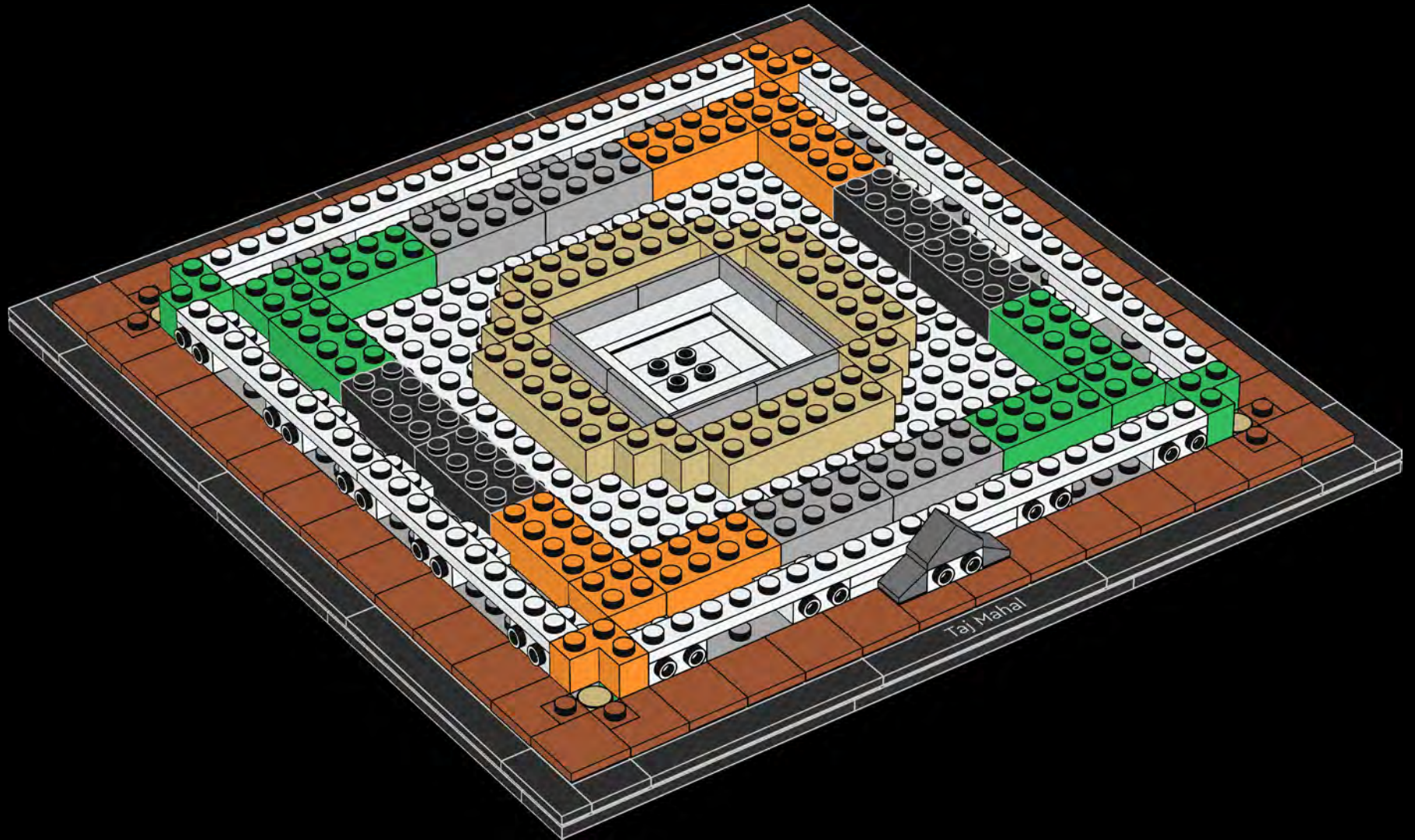





2x

30

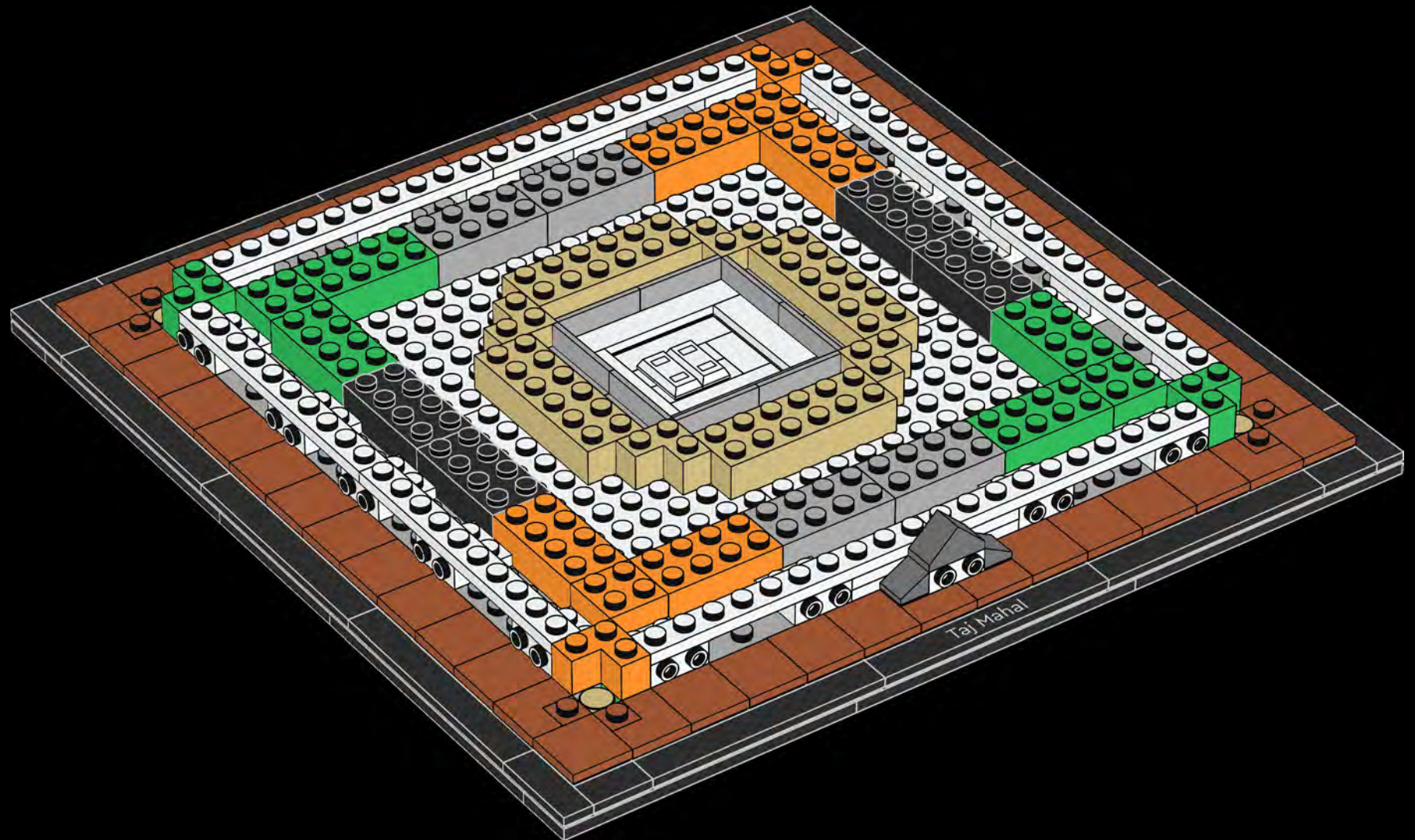



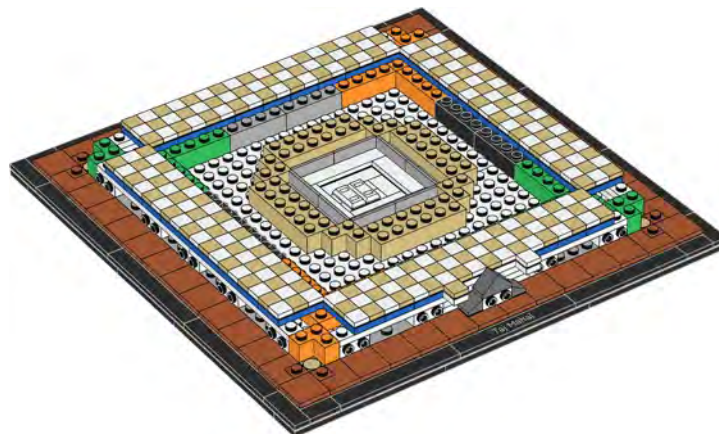
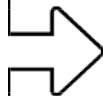



31

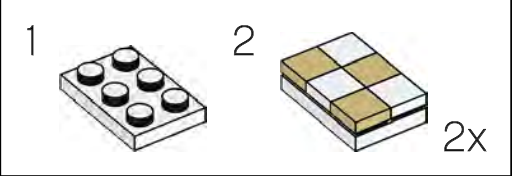
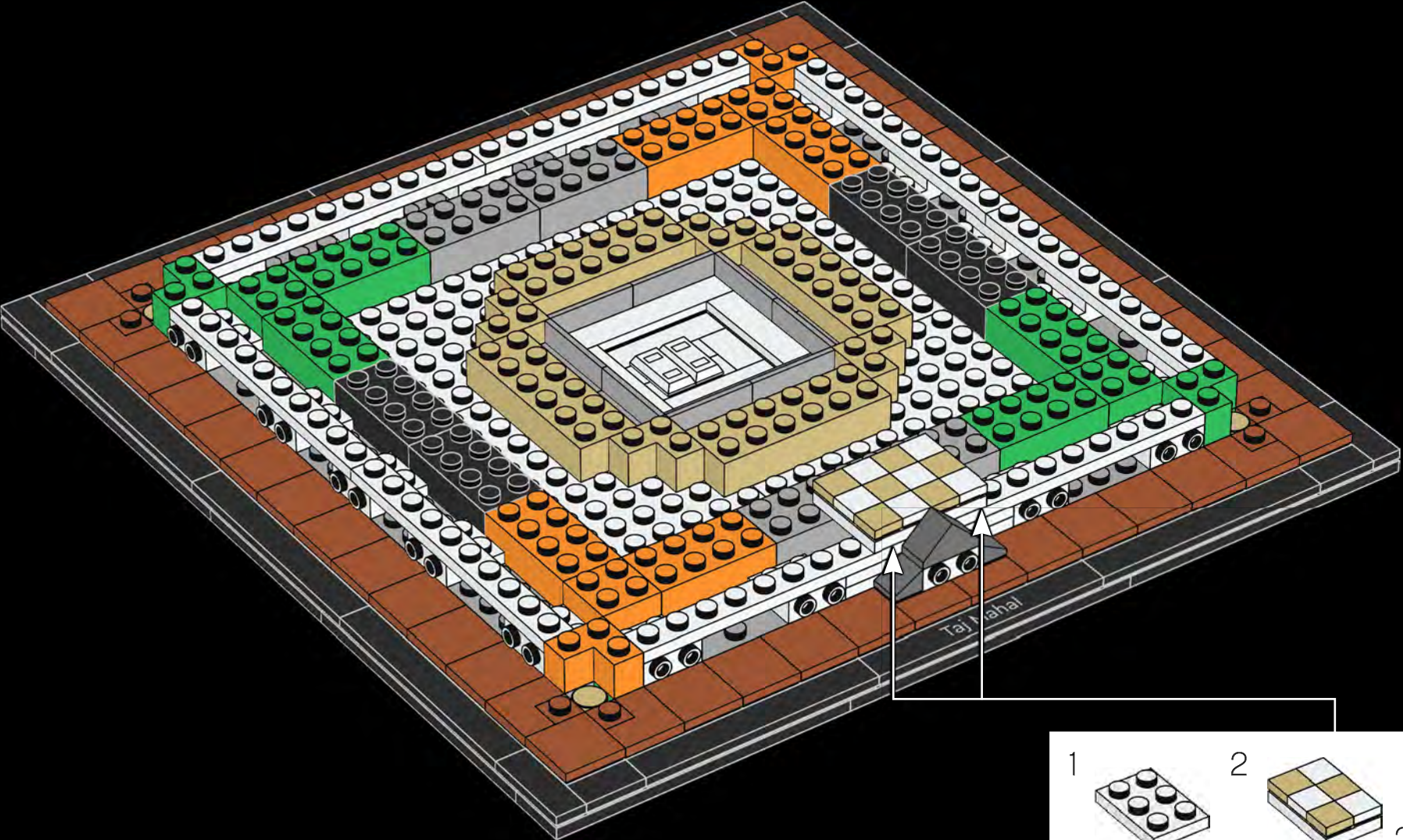





32

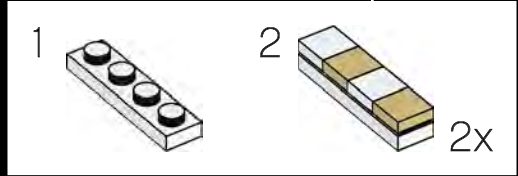
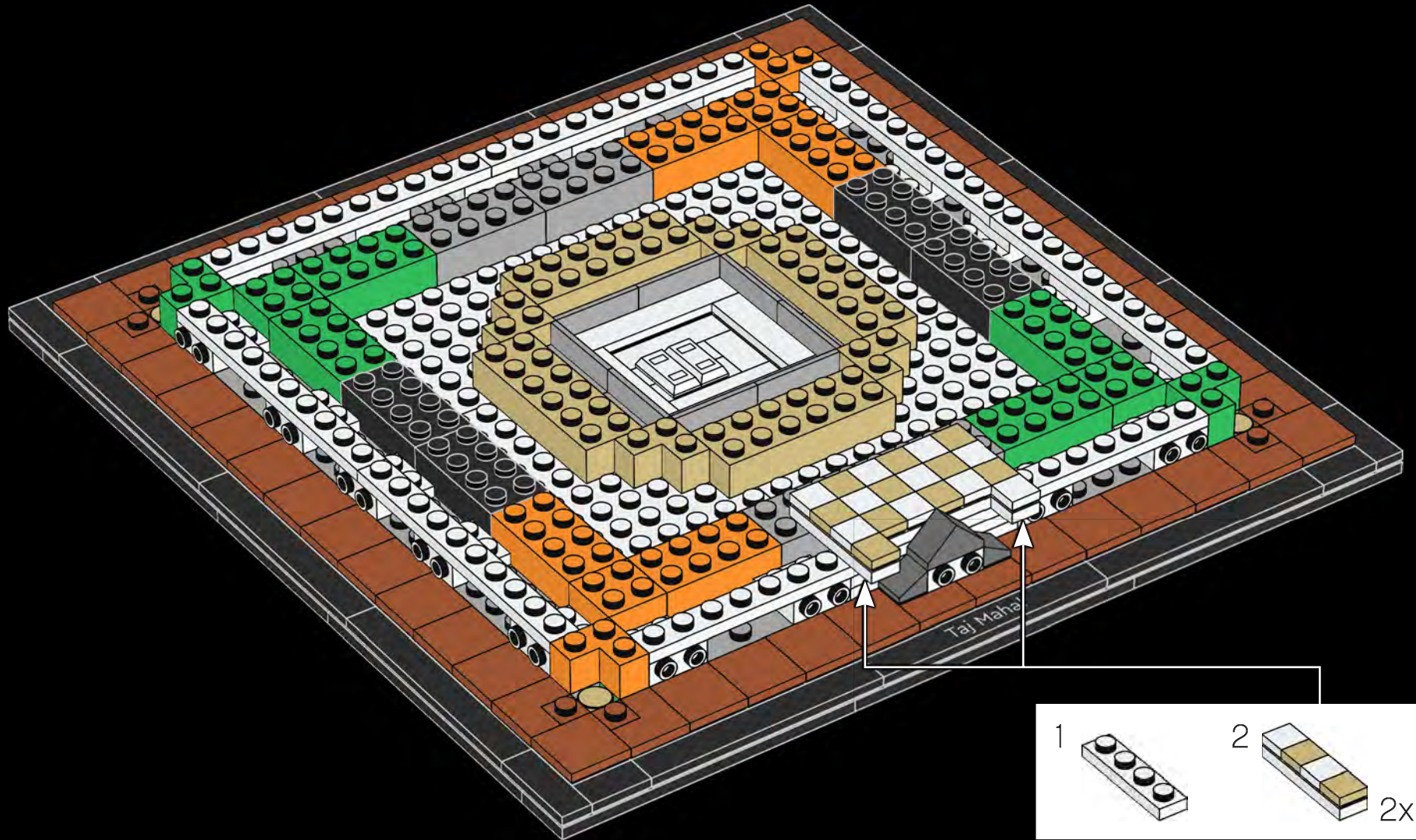





33

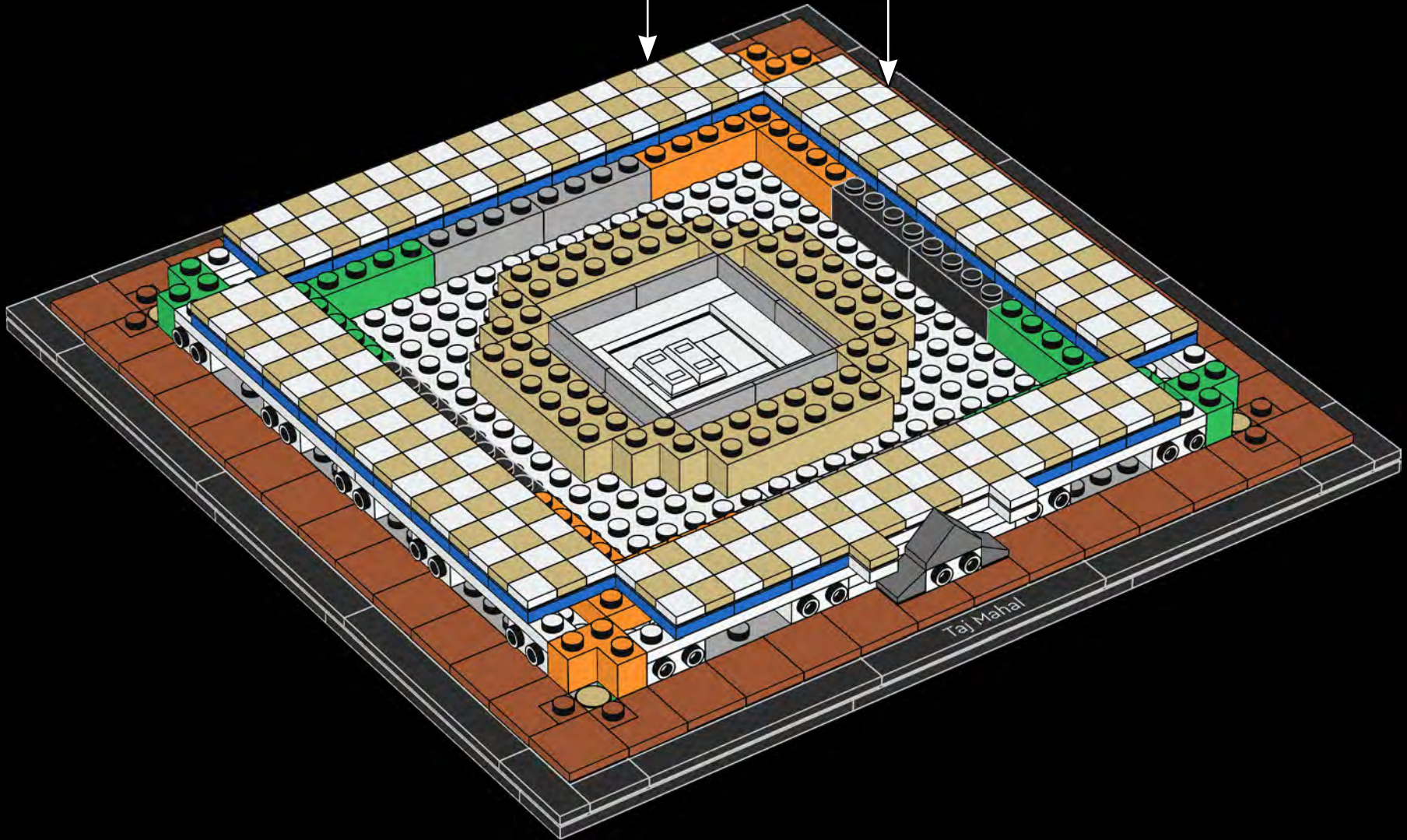
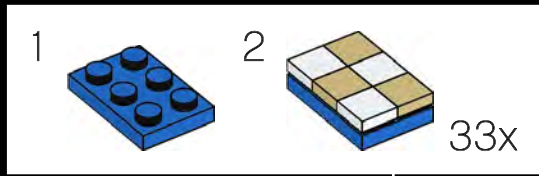

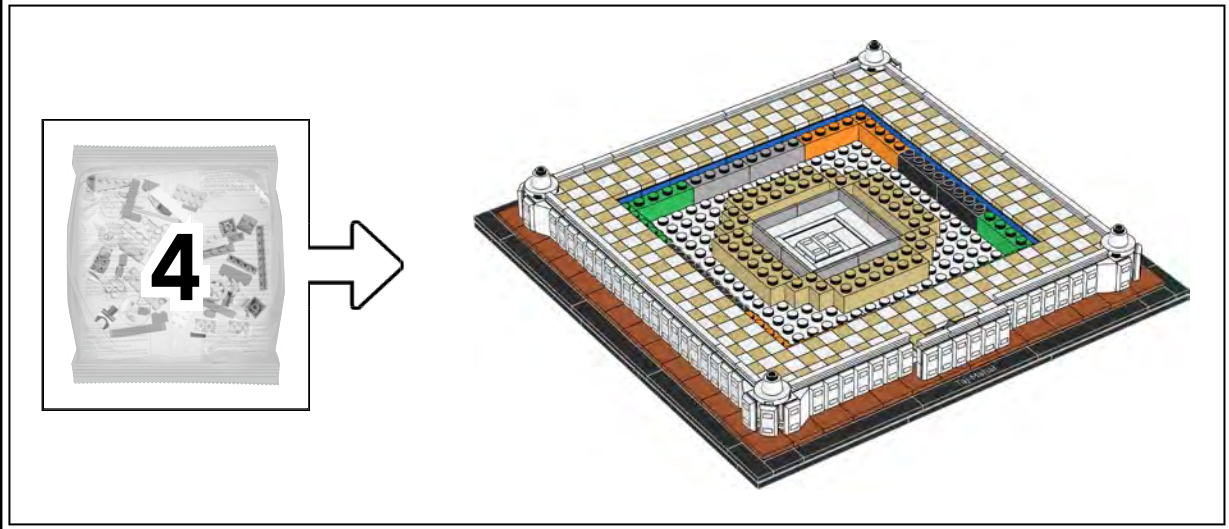





16x

34



8x

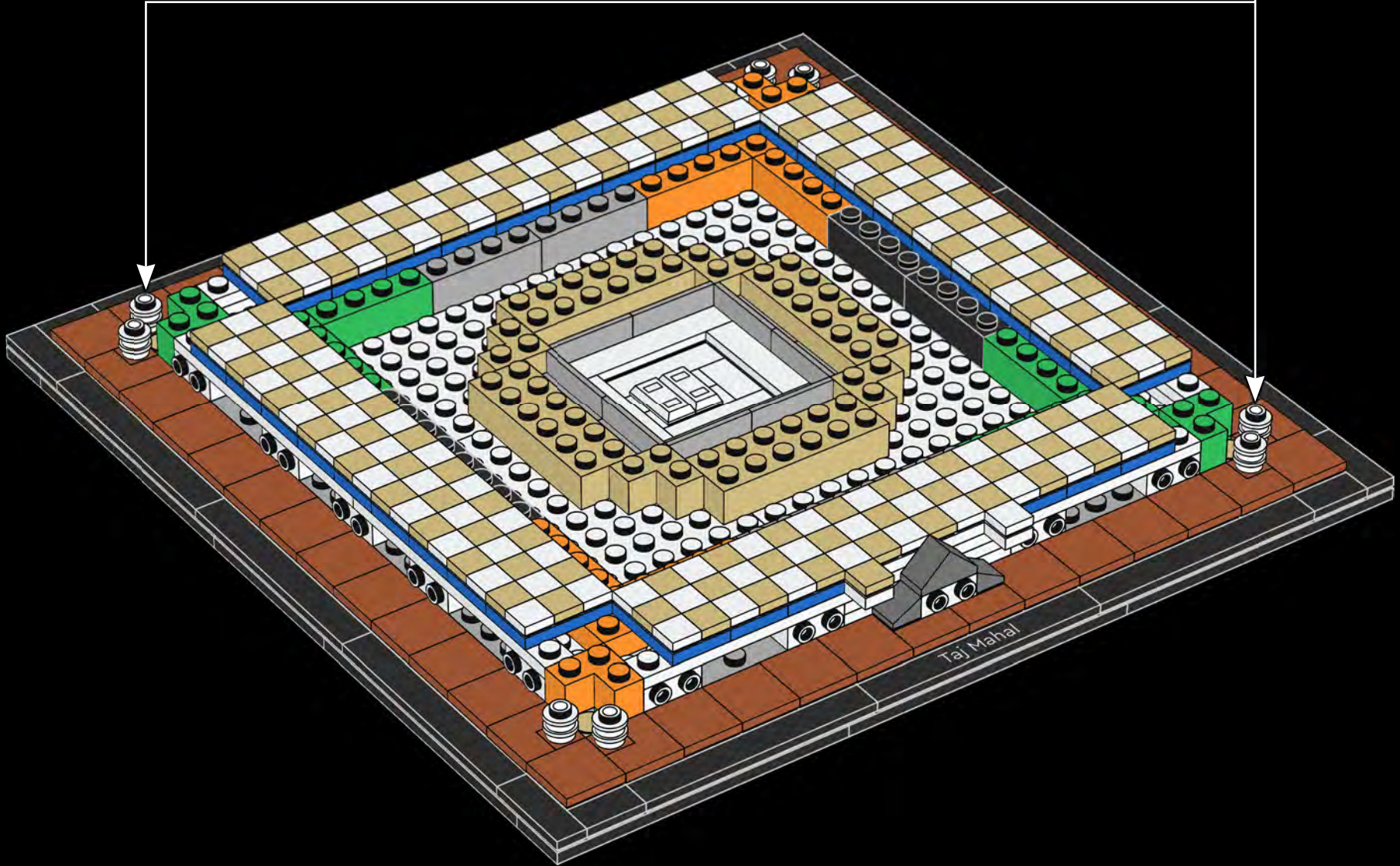



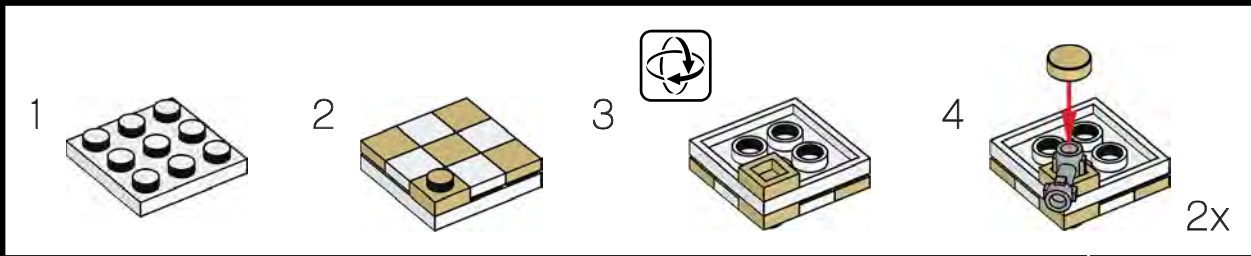
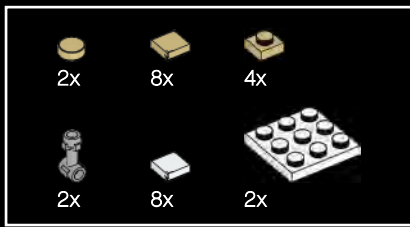

35

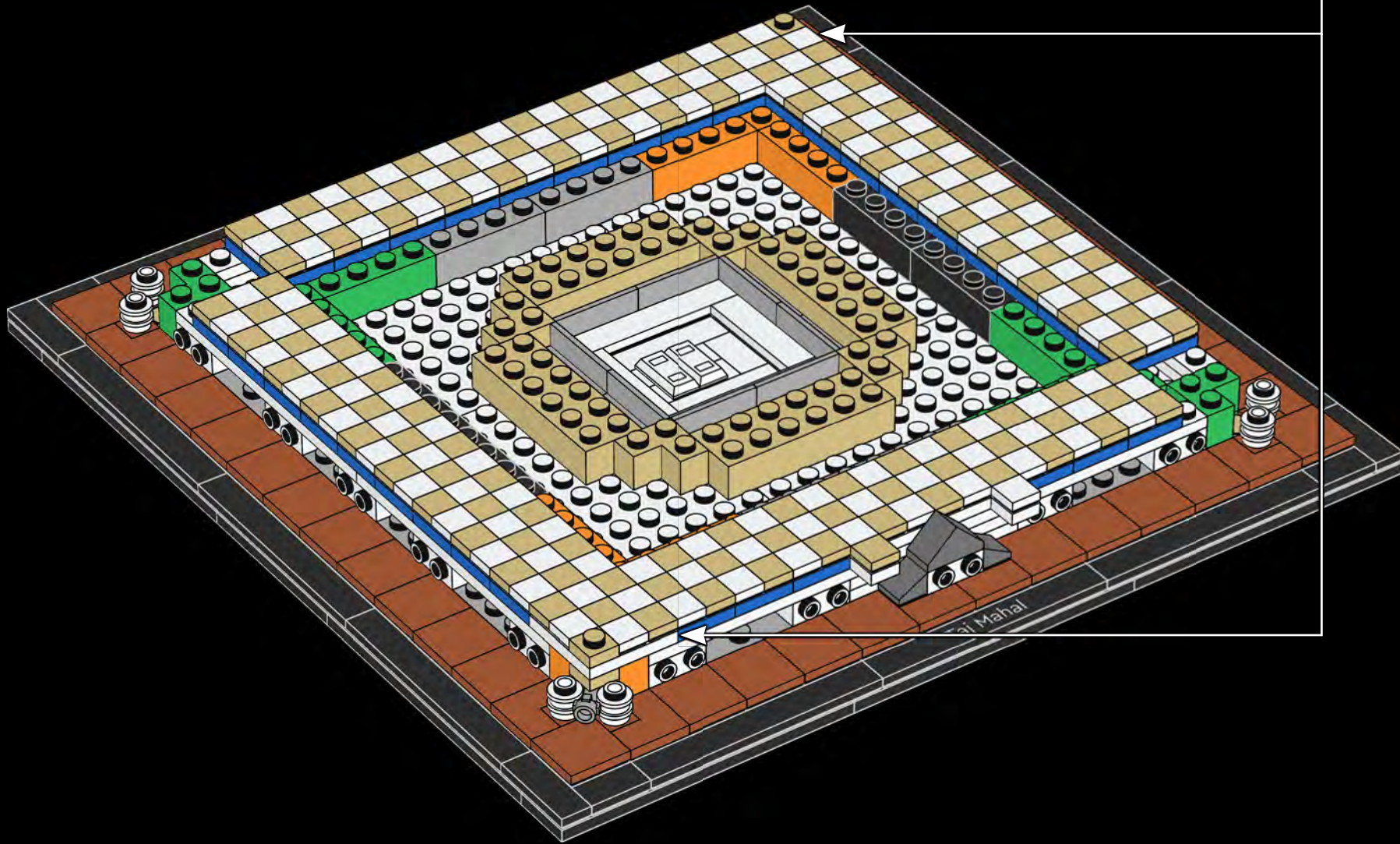



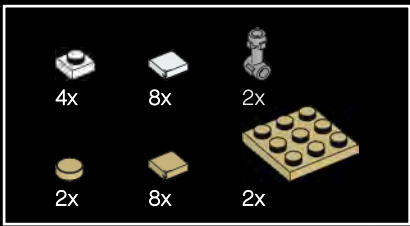

36

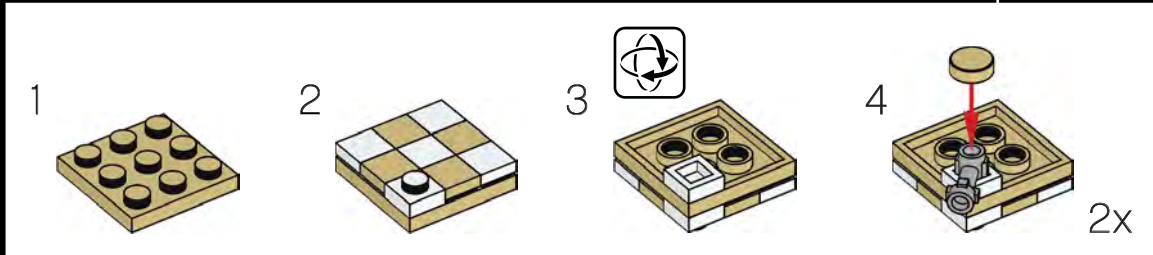
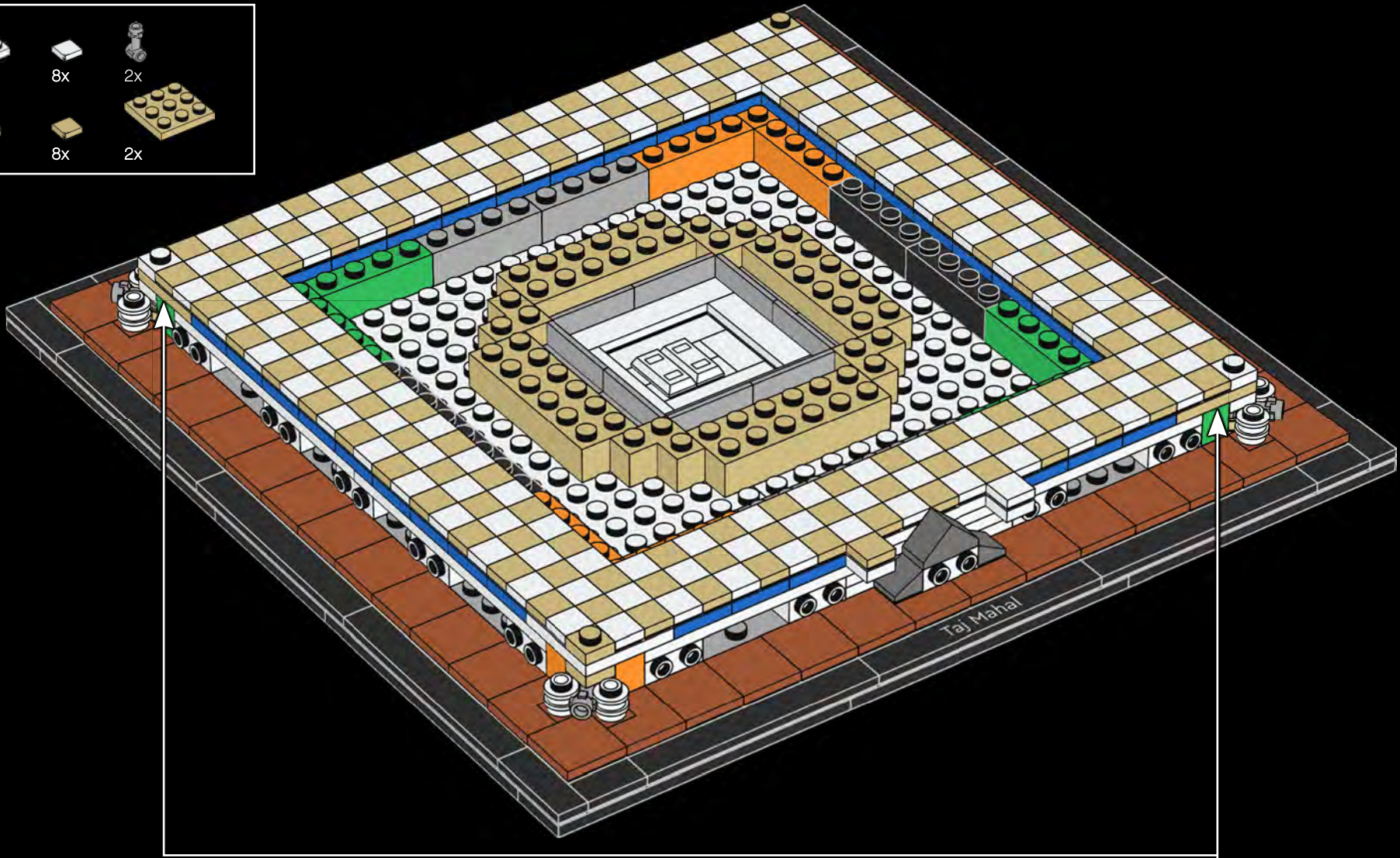



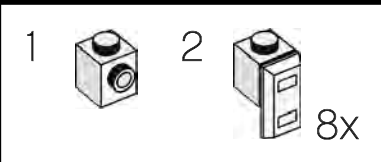
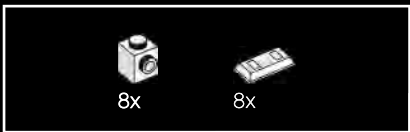

37

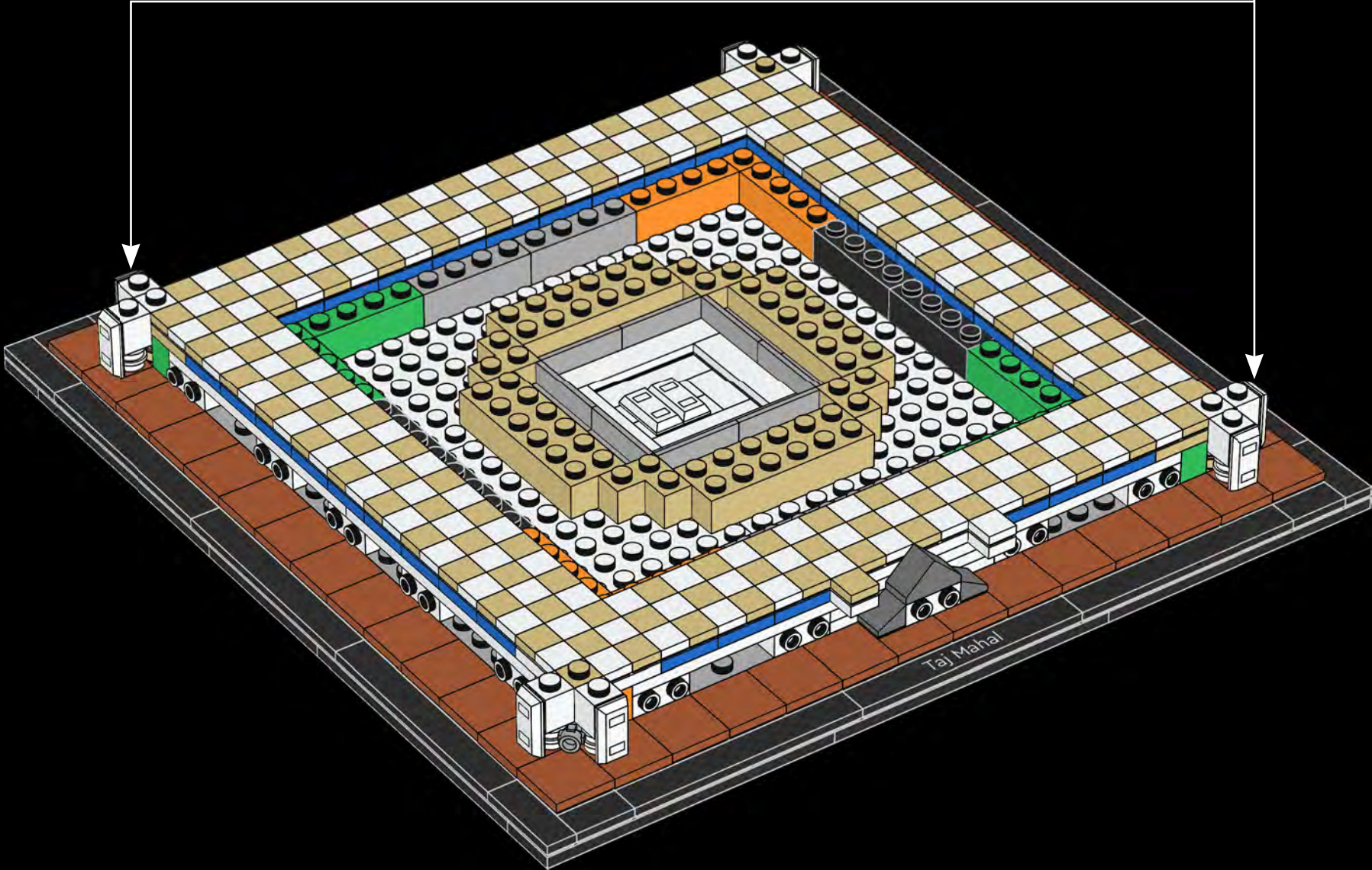





38

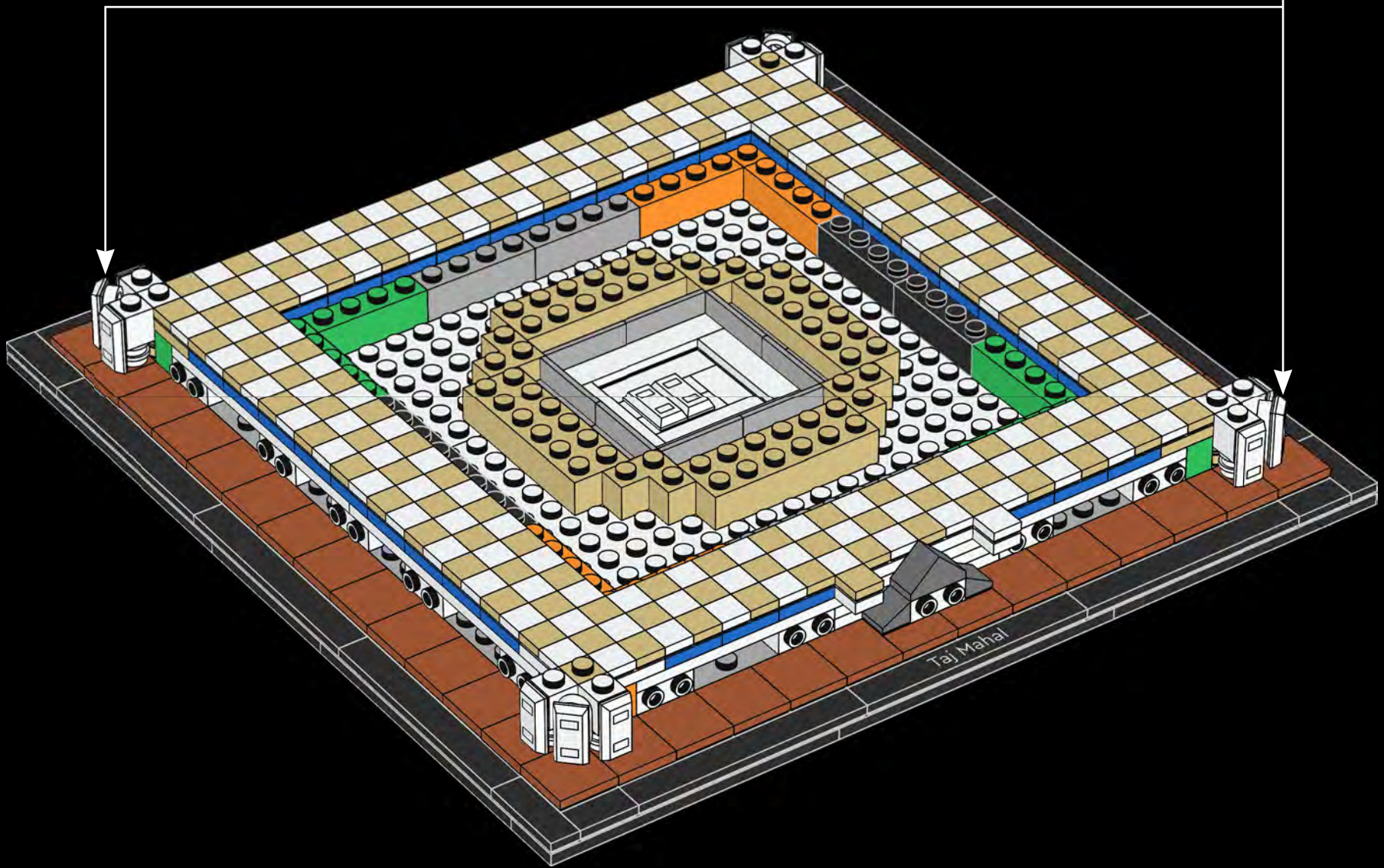
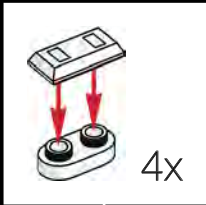





39

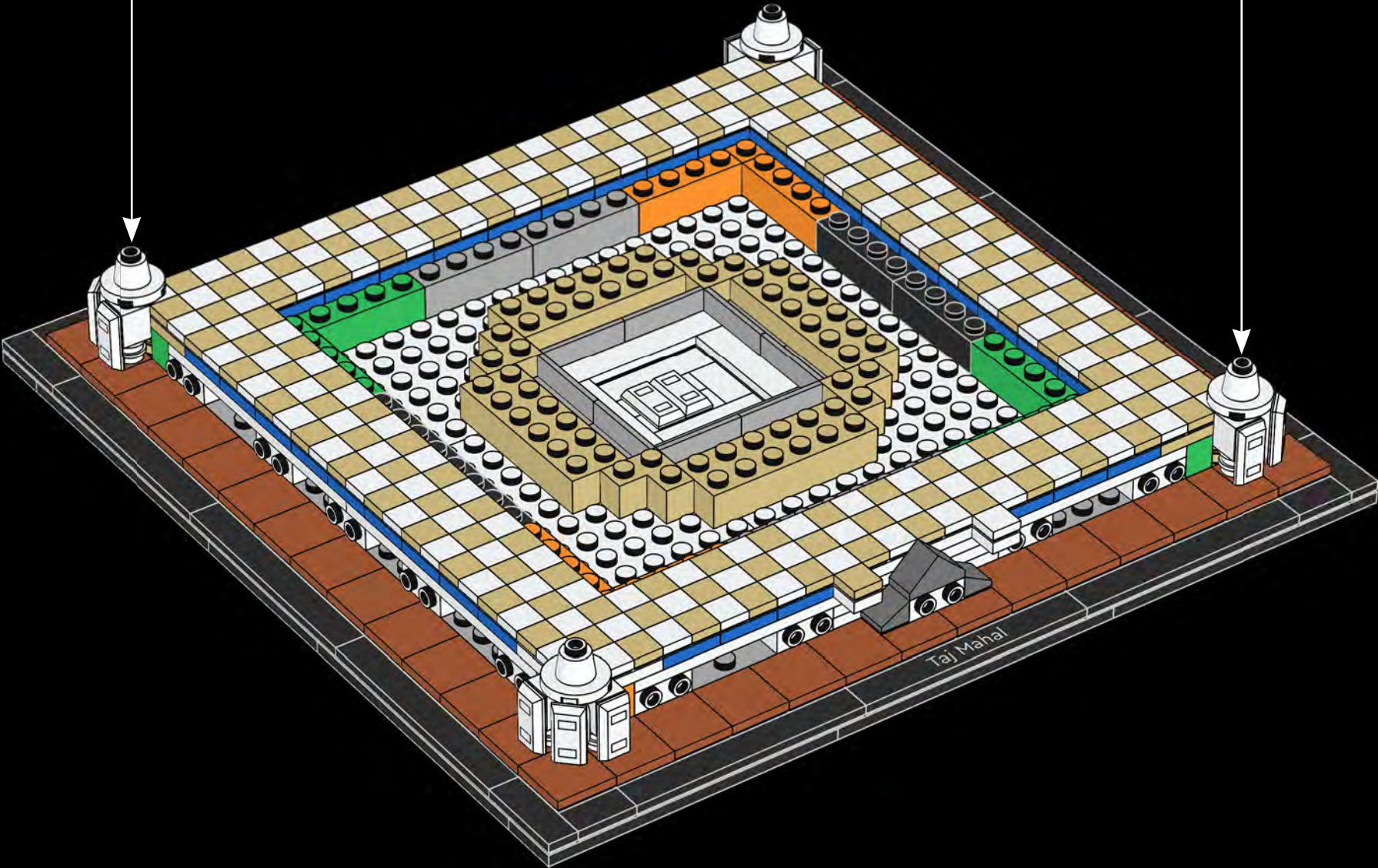



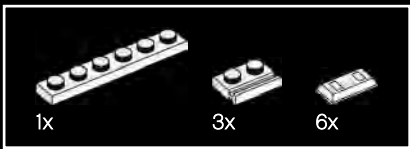

40

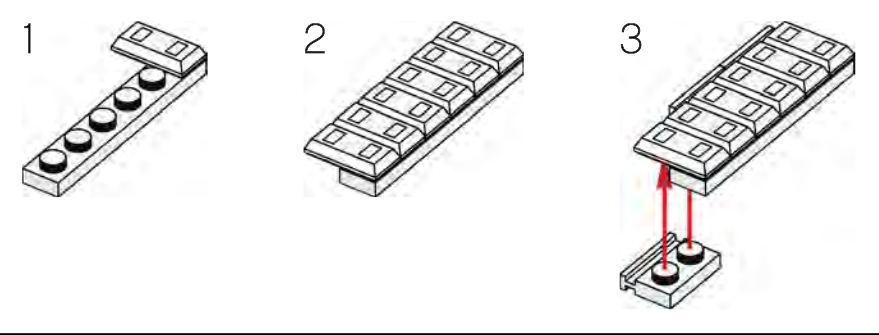
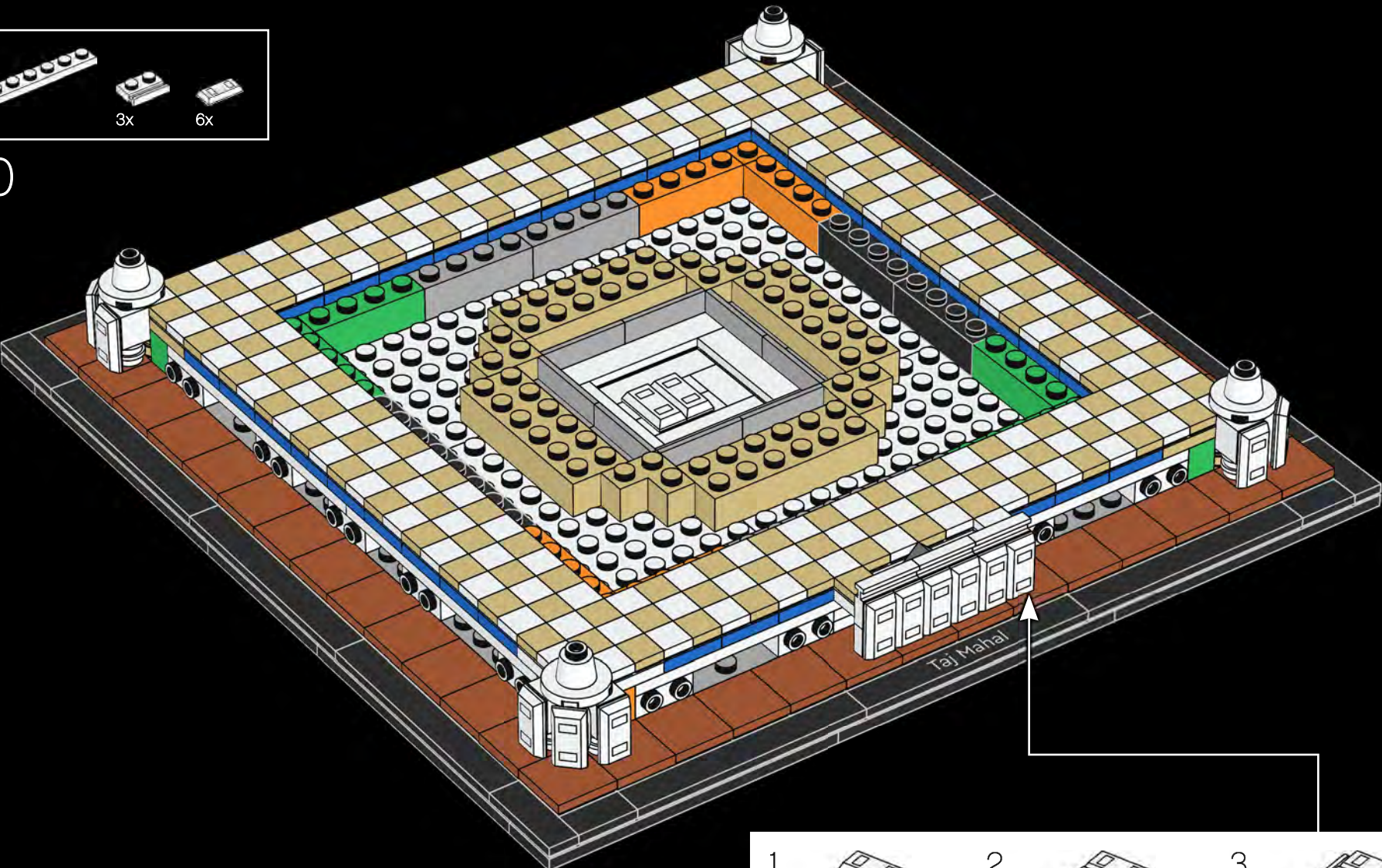

50



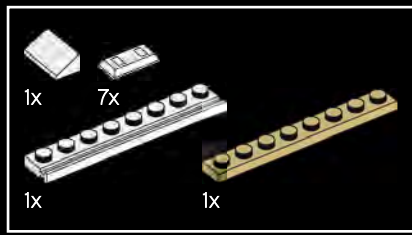

41

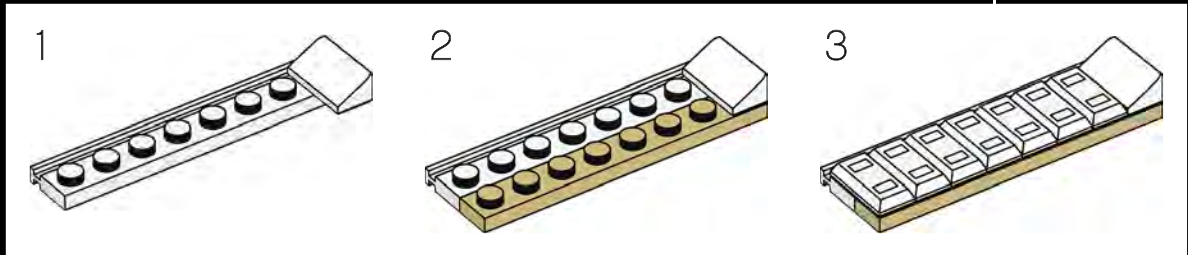
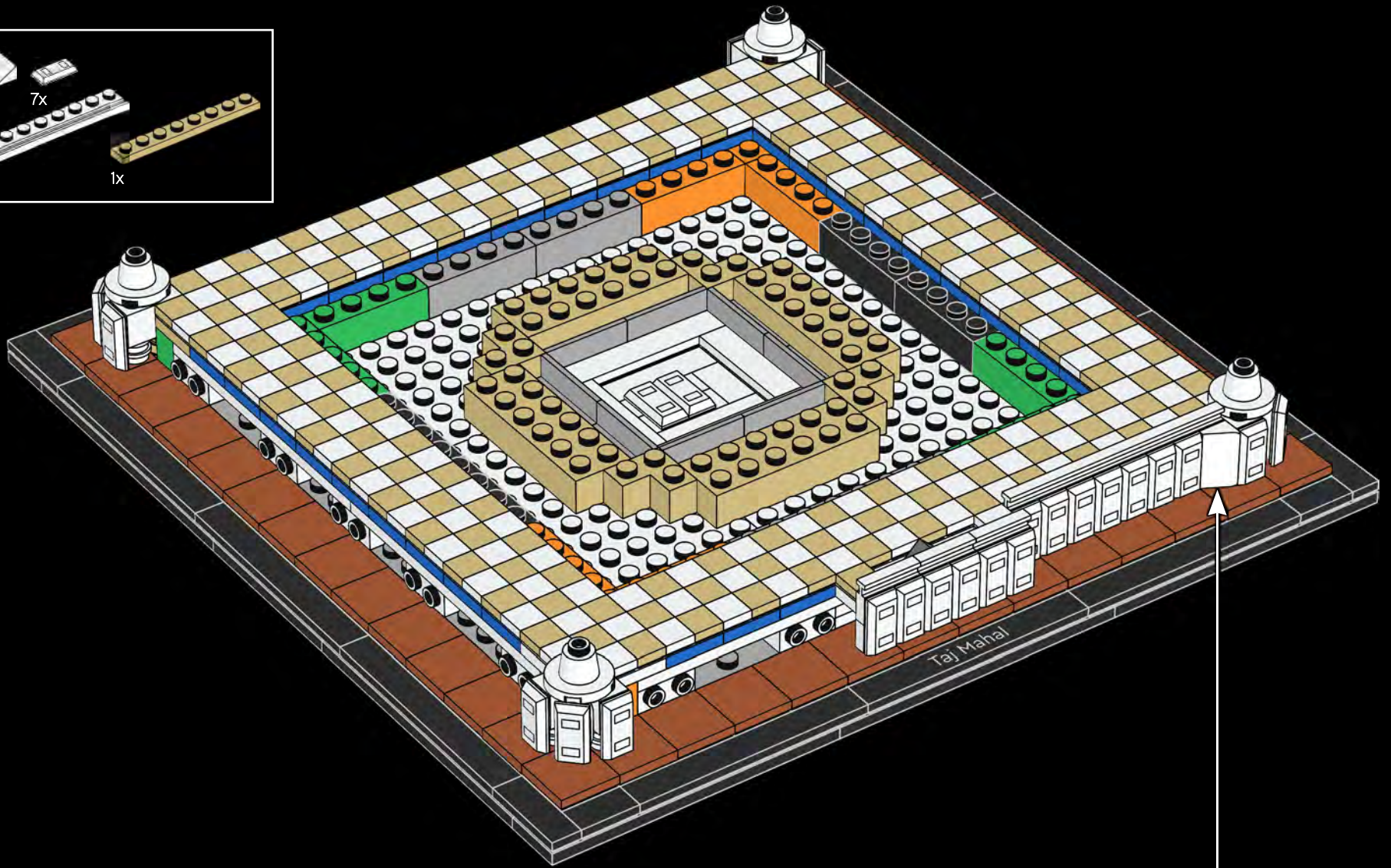



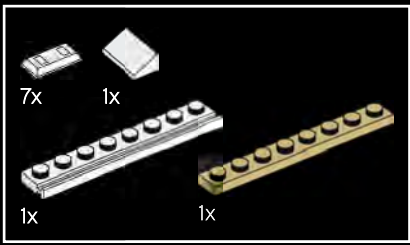

42

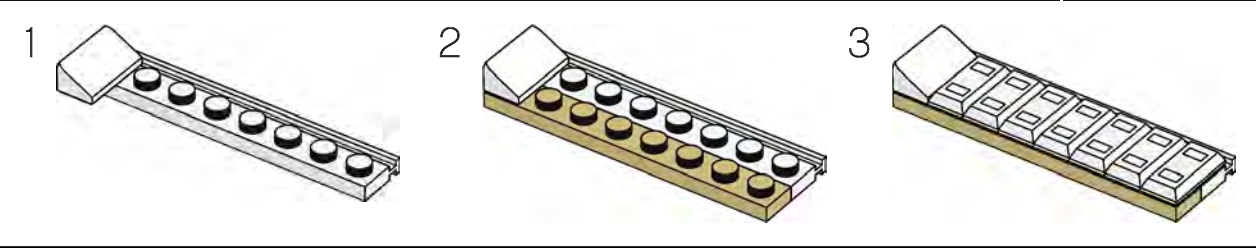
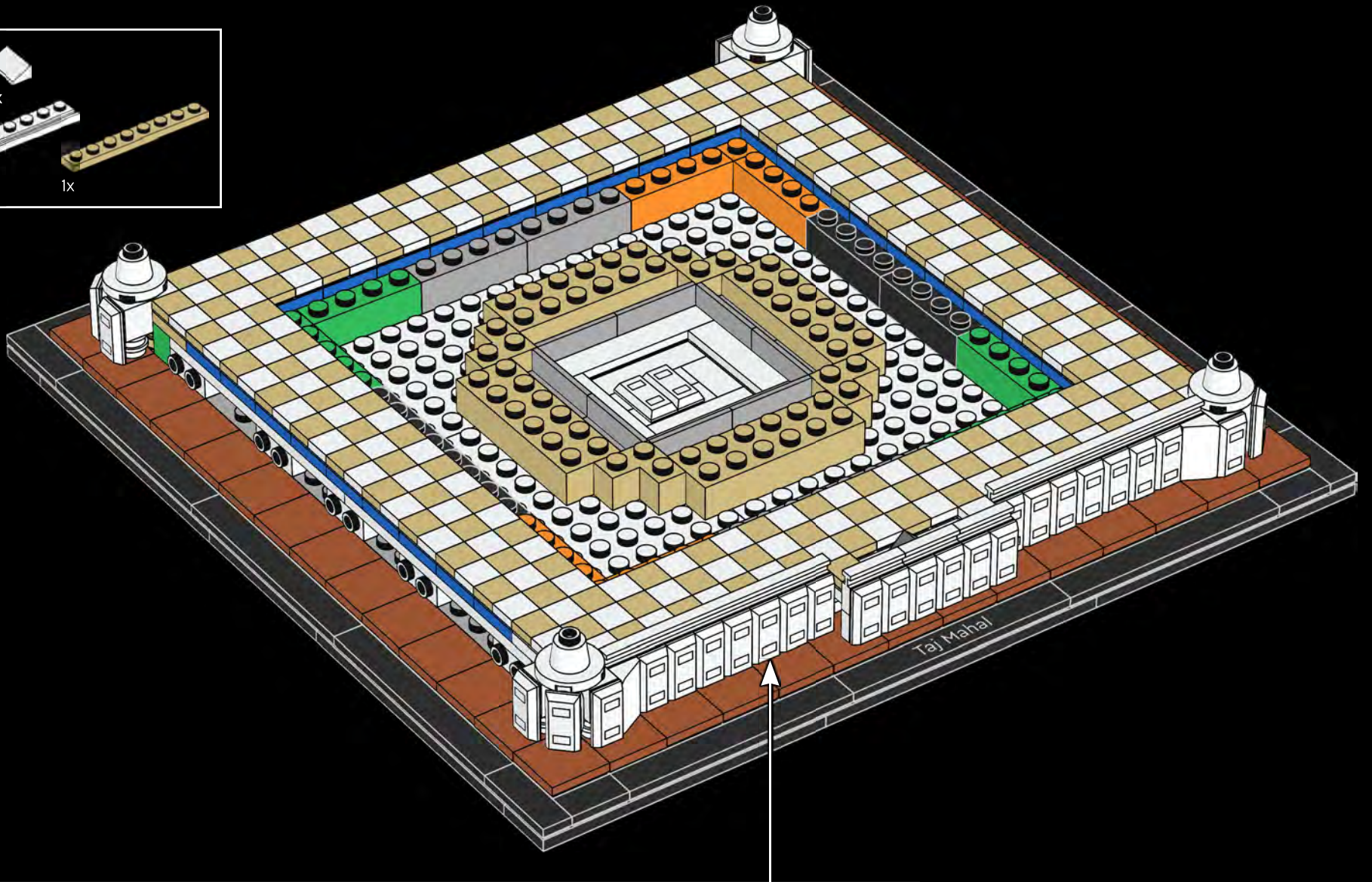

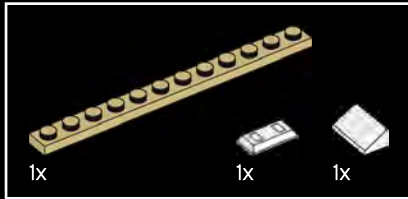
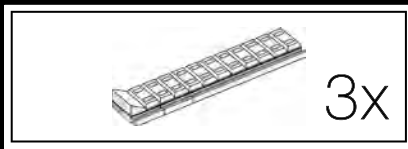

43

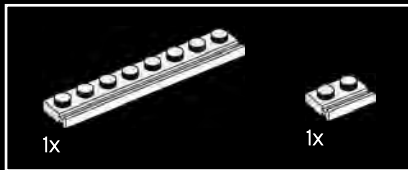

44

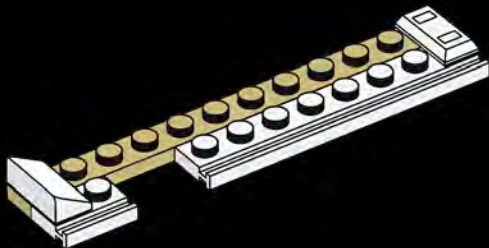

45



46



3x



47

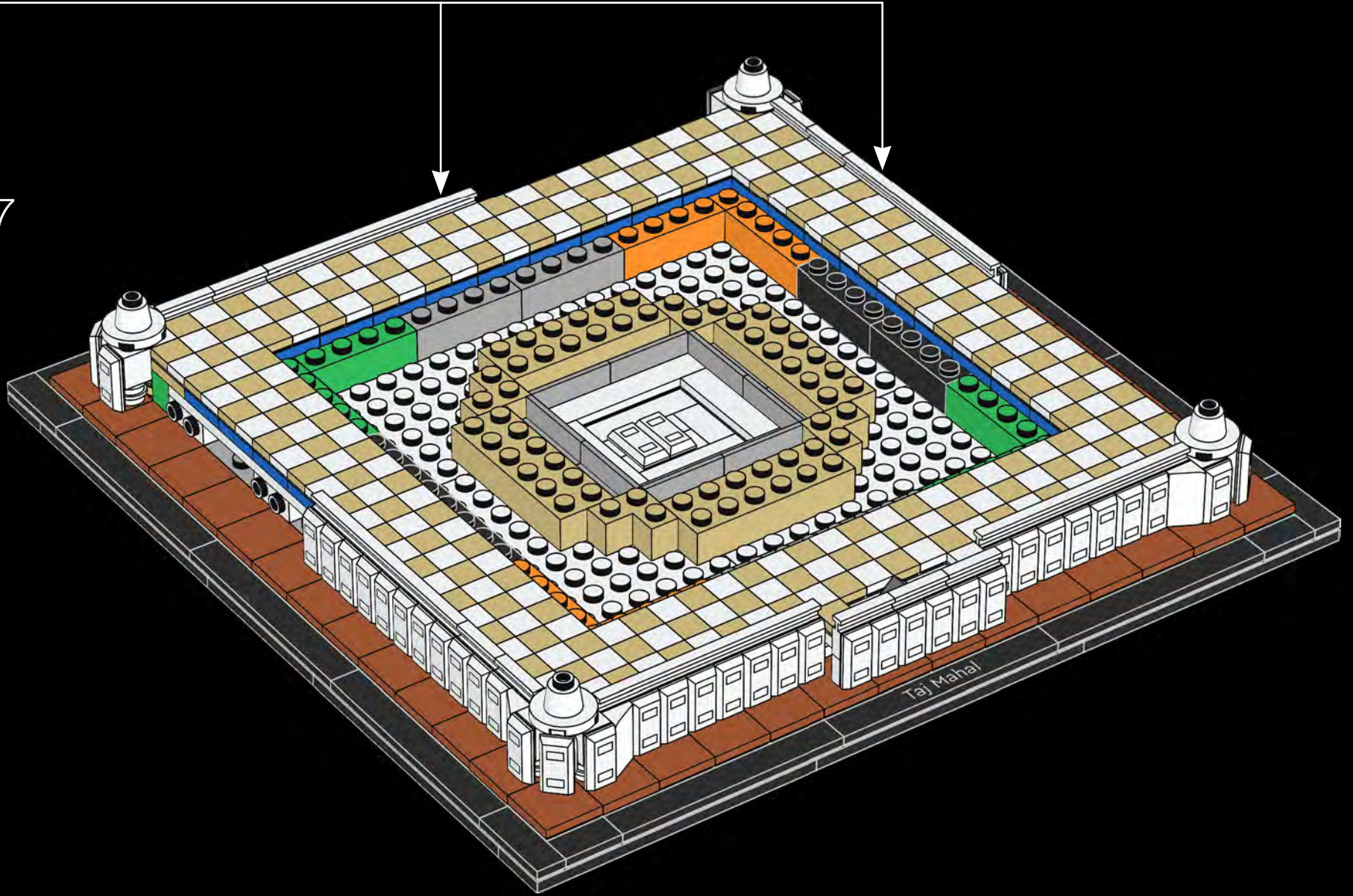

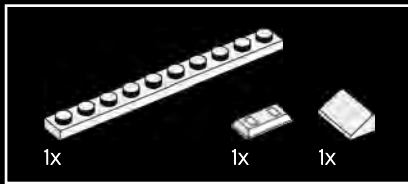
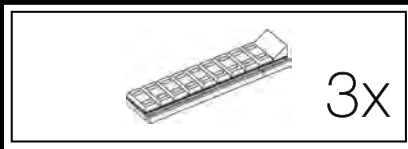

48

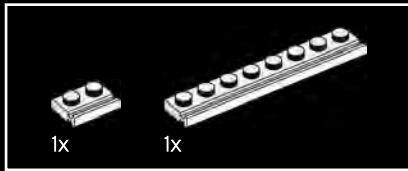
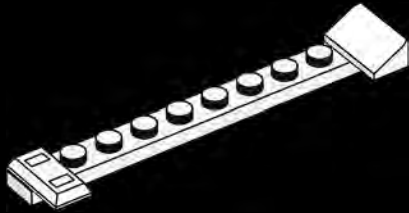

49

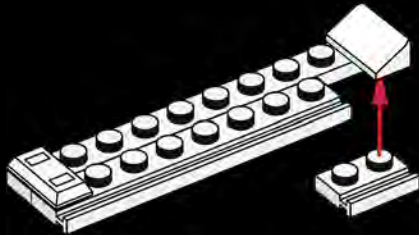

50

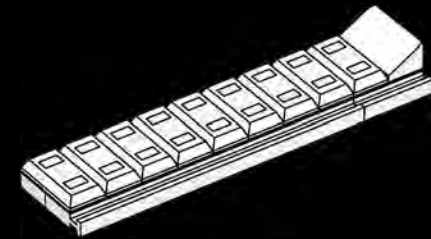

3x

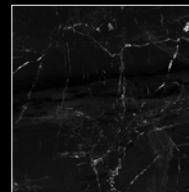

A longstanding myth holds that Shah Jahan planned a mausoleum to be built in black marble as a Black Taj Mahal across the Yamuna river.

Une vieille légende soutient que Shâh Jahân avait prévu de construire un mausolée en marbre noir, une réplique noire du Taj Mahal, sur l'autre rive de la rivière Yamuna.

Según una vieja leyenda, Shah Jahan planeó la construcción de un mausoleo de mármol negro al otro lado del río Yamuna: el Taj Mahal Negro.



51

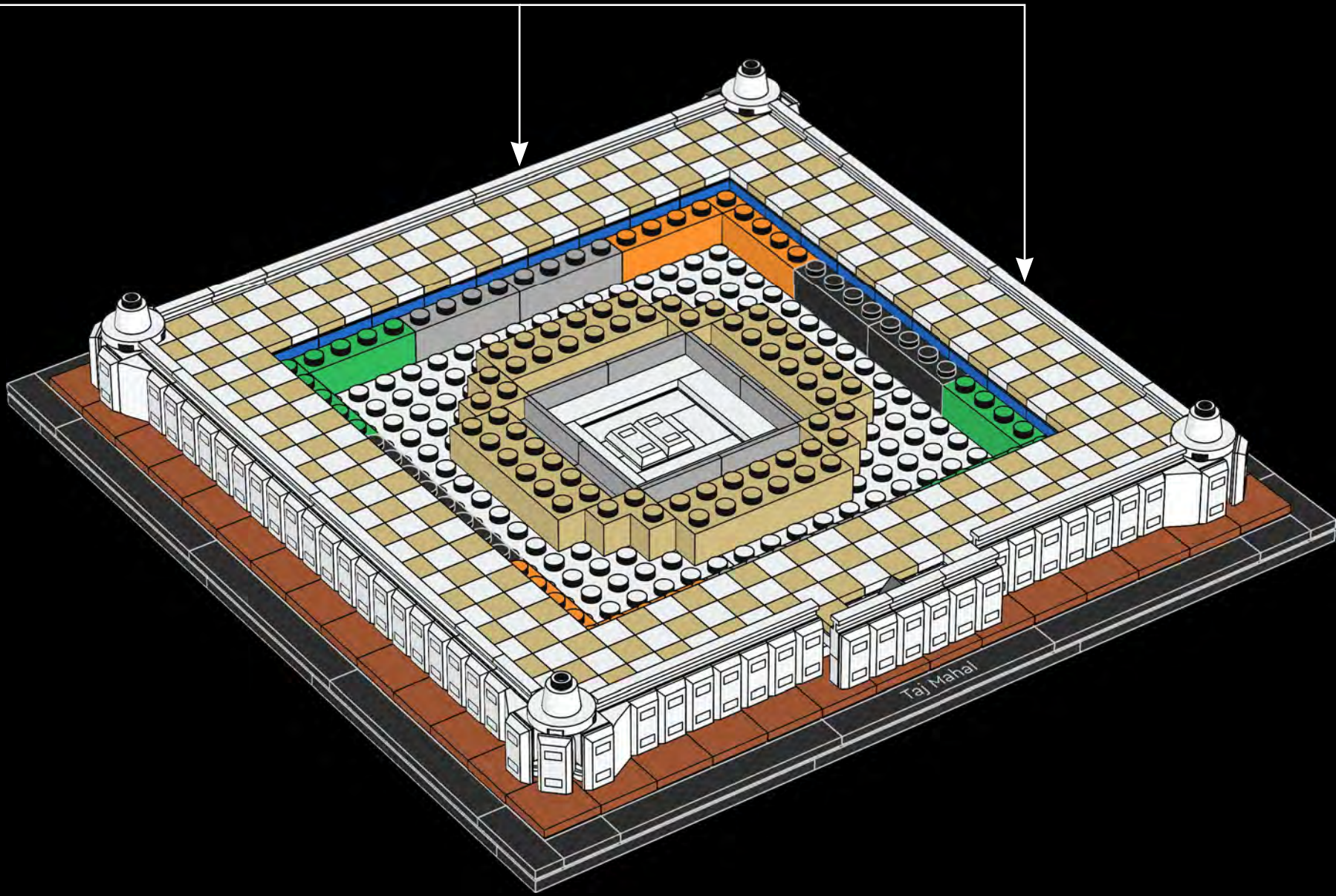

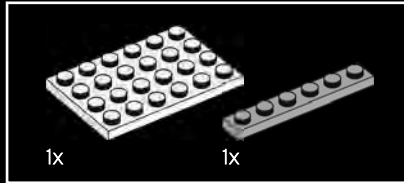
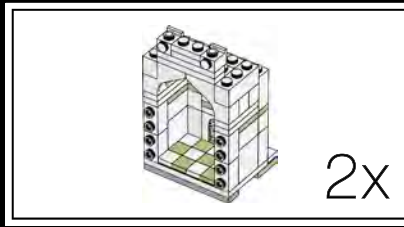
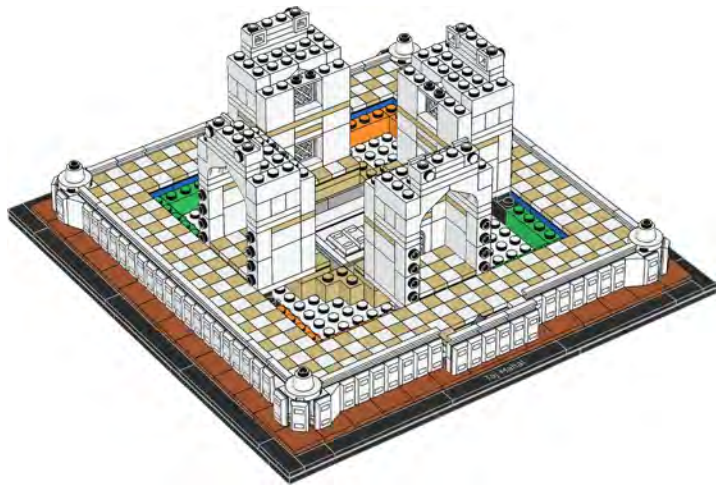
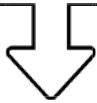

52

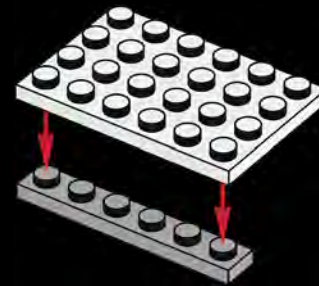





53

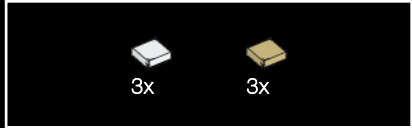

54

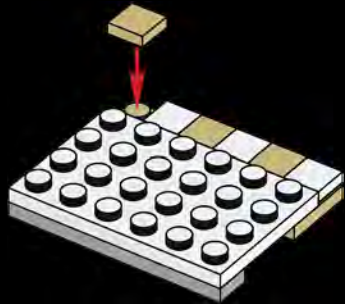

55

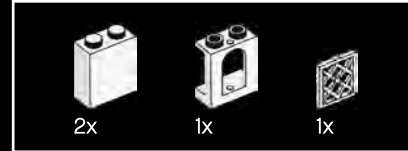
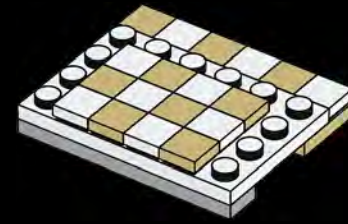

56

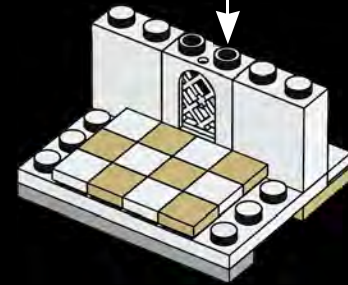
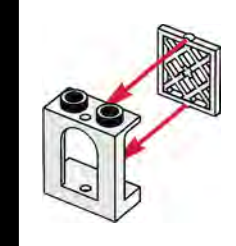



57

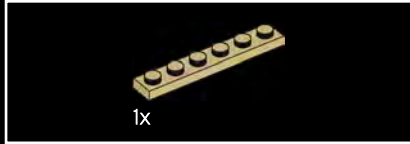
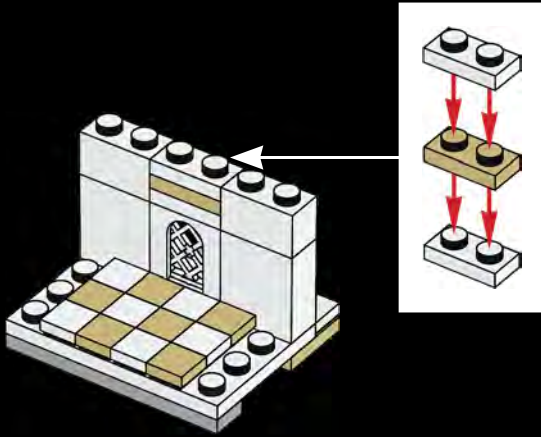

58

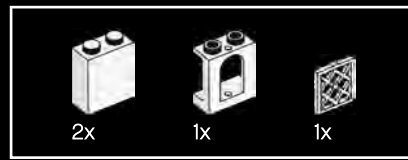
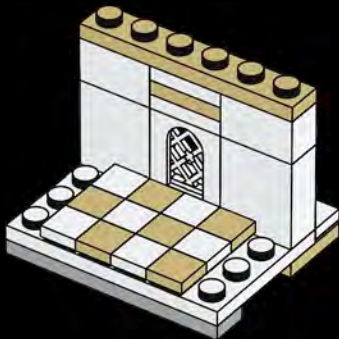

59

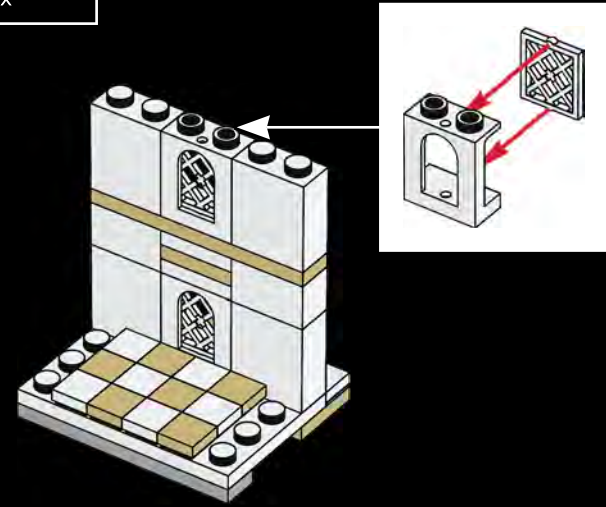

60

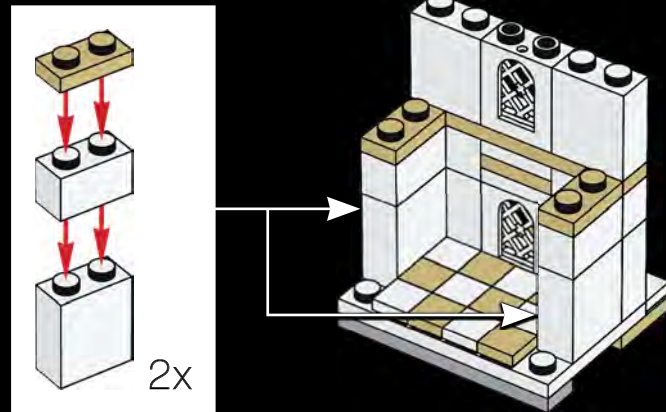





4x

61

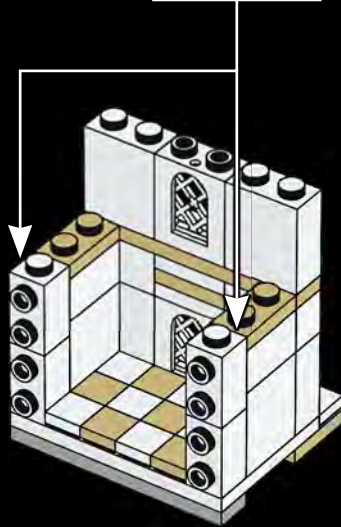
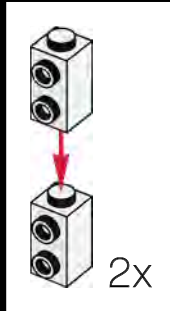

4x

62

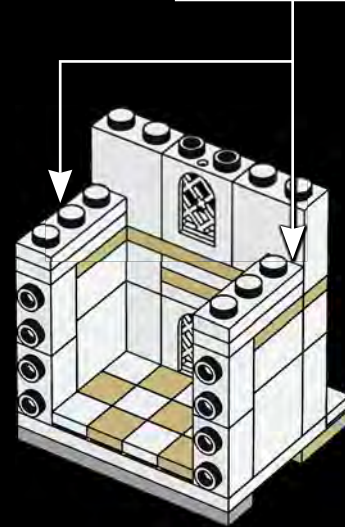
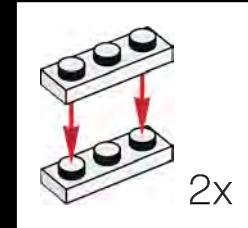

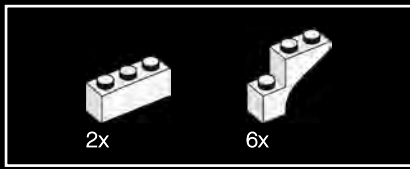

63

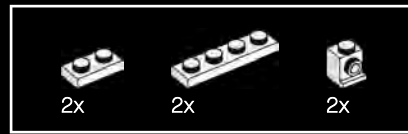
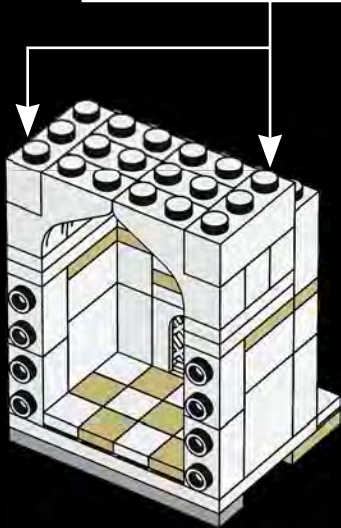
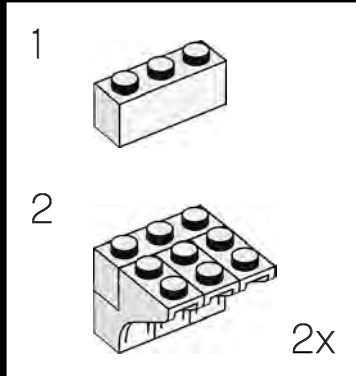

64

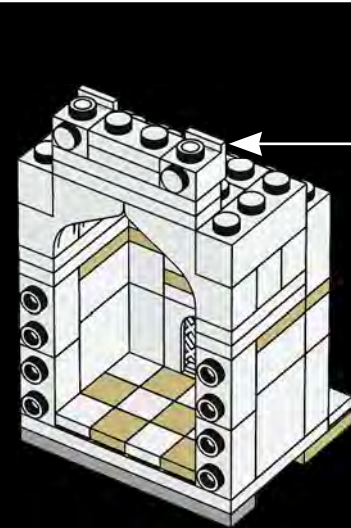
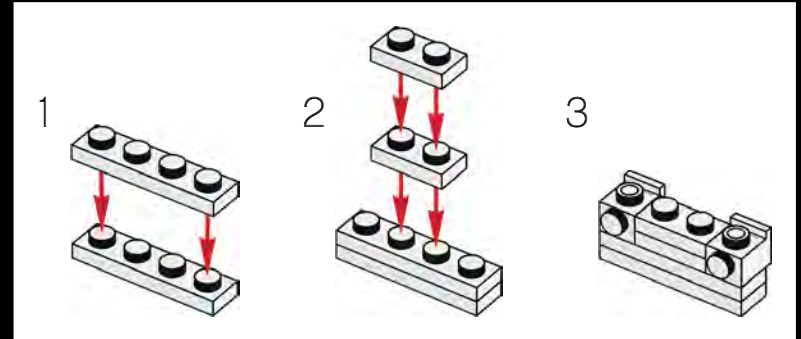

2x



65



A total of 28 different types of precious and semiprecious jewels are set in the white marble.

Un total de 28 différents types de pierres précieuses et semi-précieuses sont incrustés dans le marbre blanc.

El mármol blanco está decorado con un total de 28 tipos diferentes de piedras preciosas y semipreciosas.



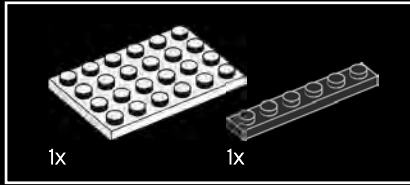
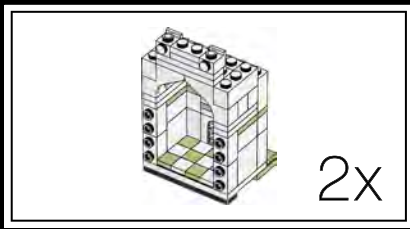

66

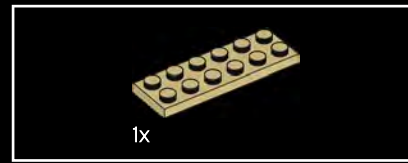
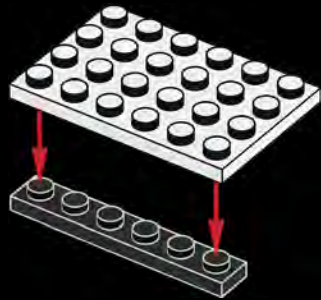

67

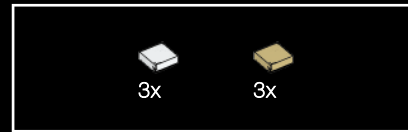

68

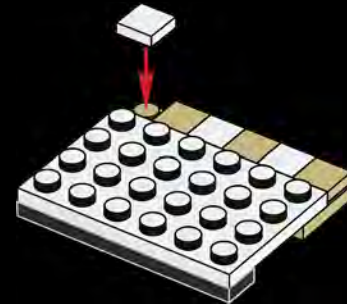



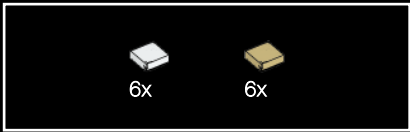

69

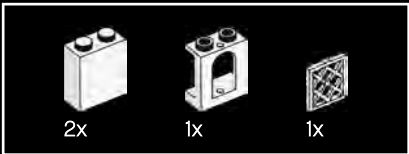

70

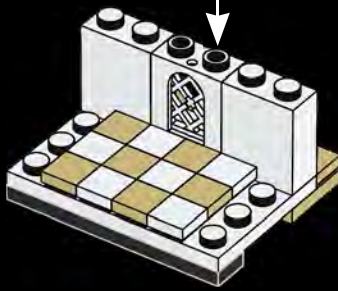
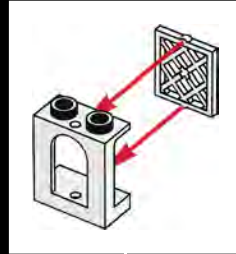



71

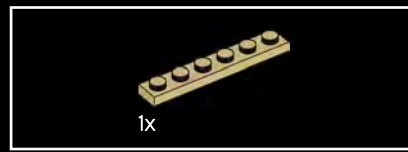
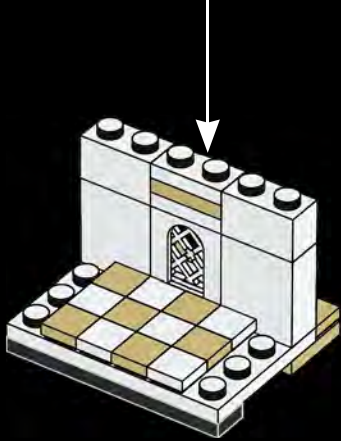
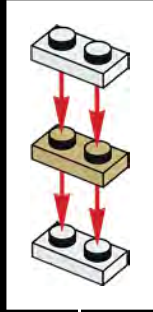

72

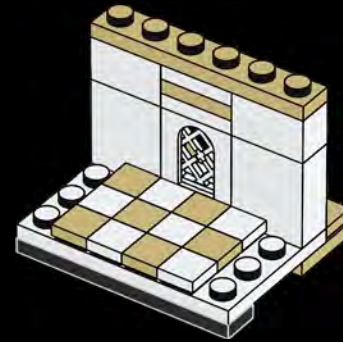



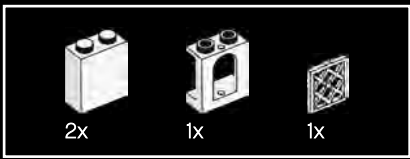

73

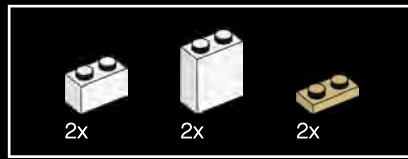
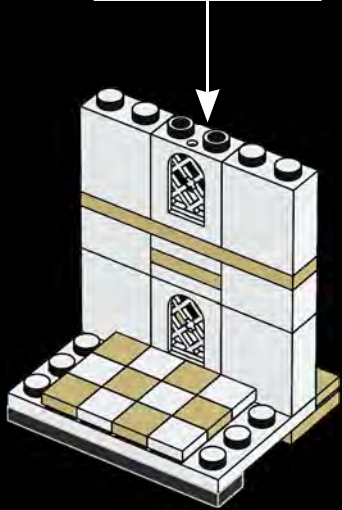
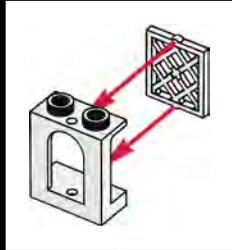

74

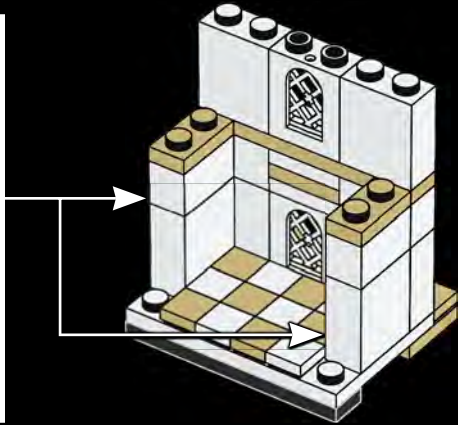
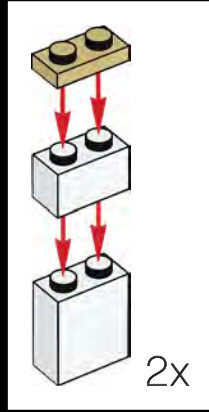



75

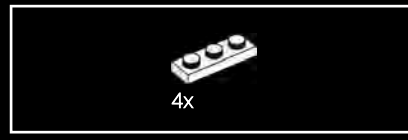
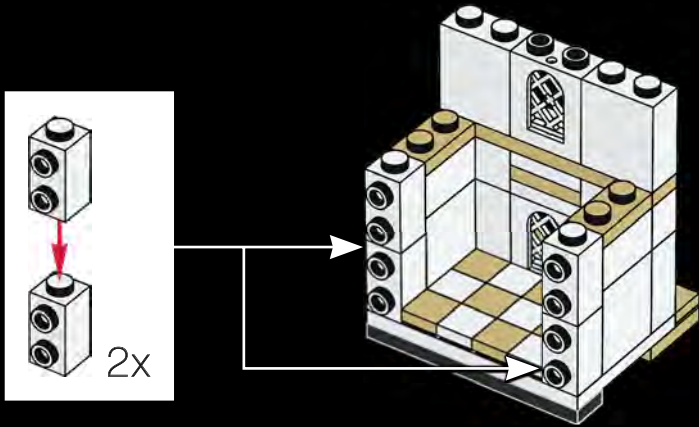

76

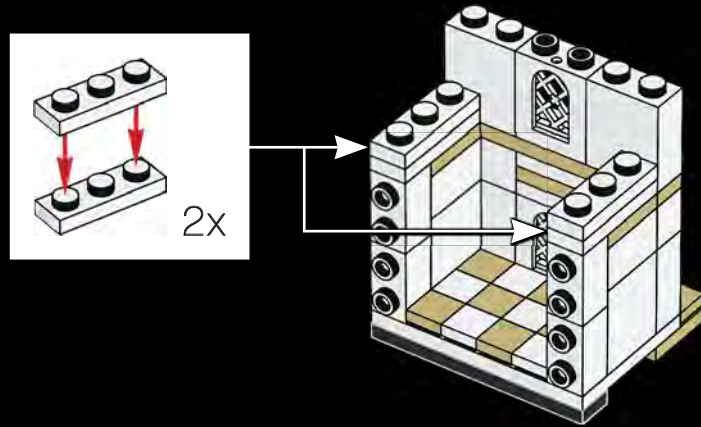



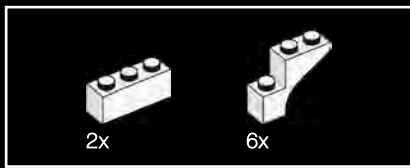

77

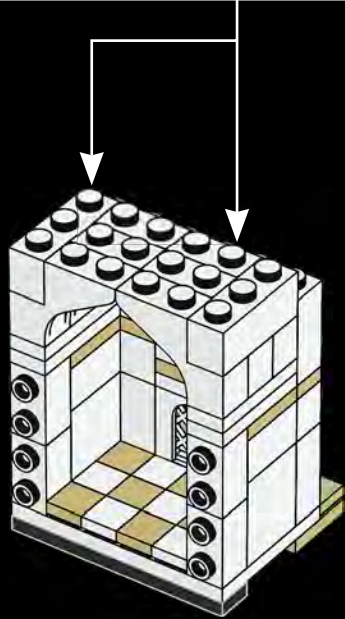
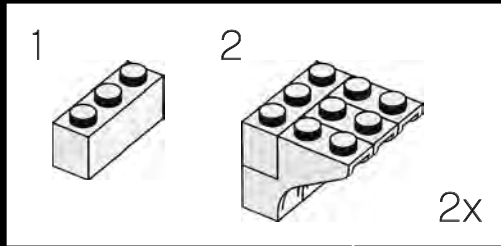

78

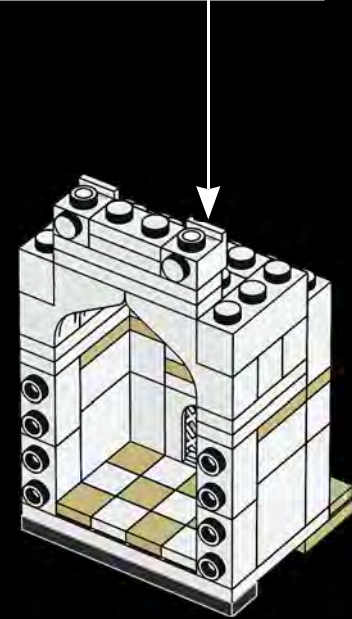
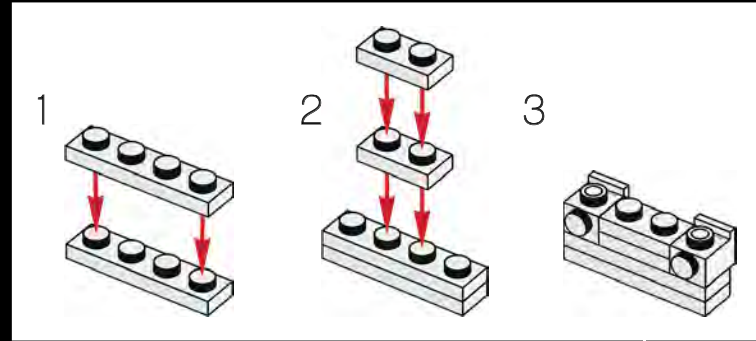

2x

79

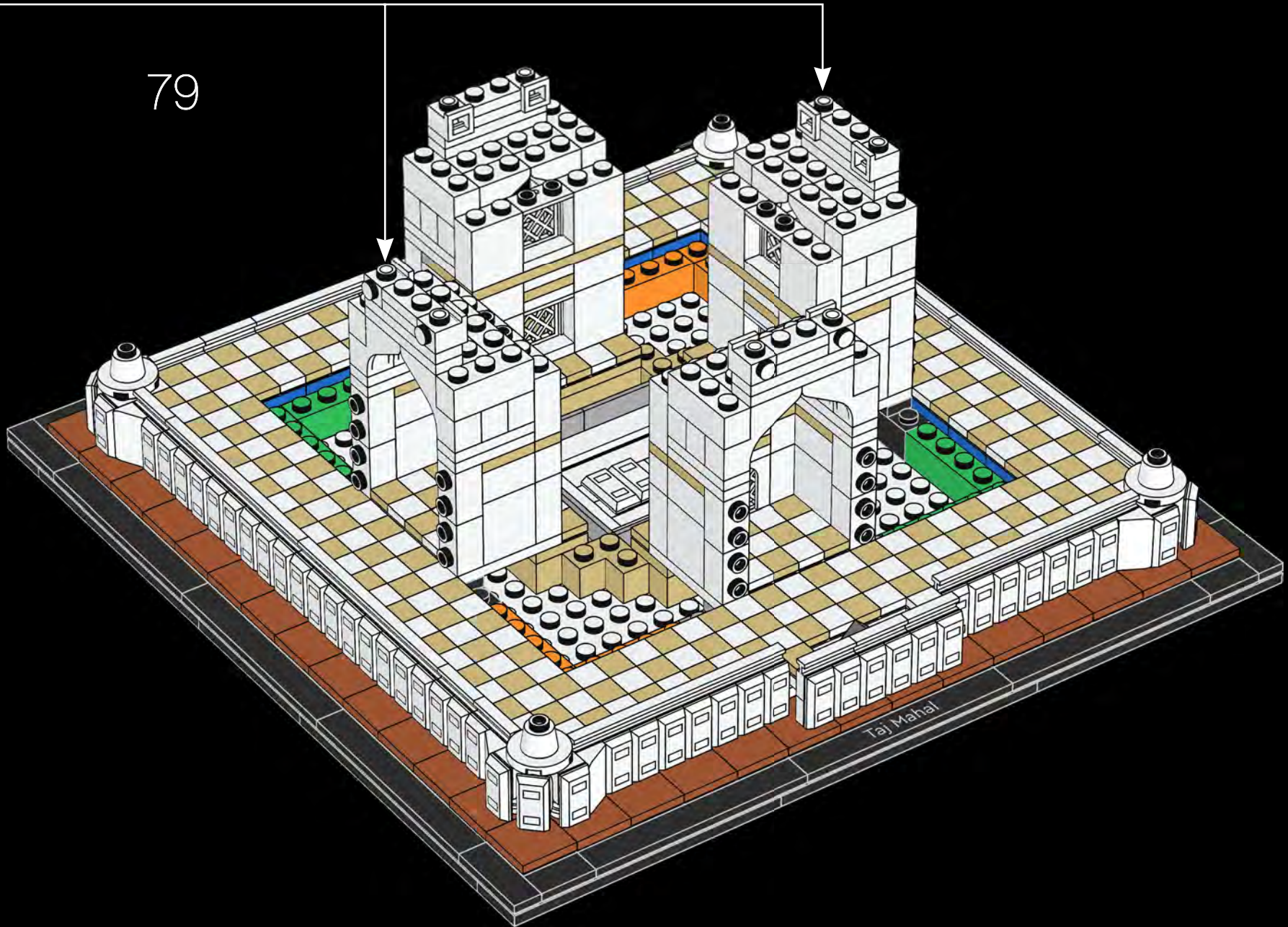



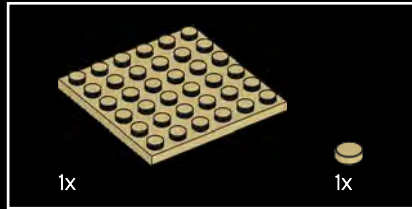
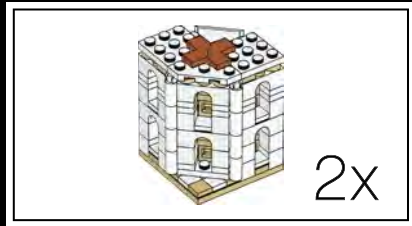
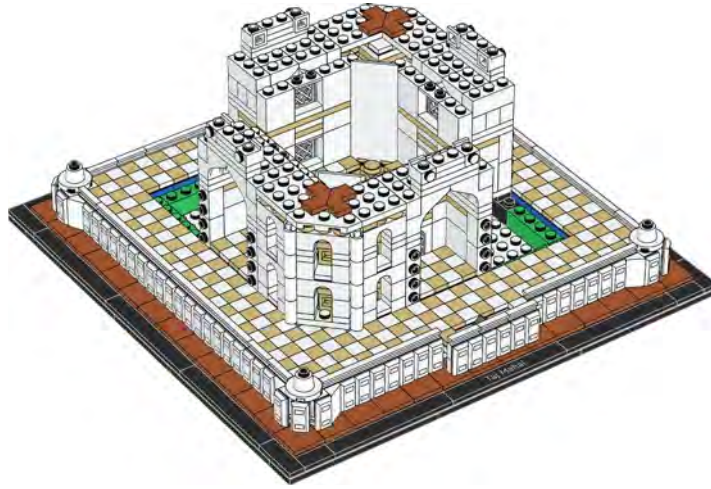

80

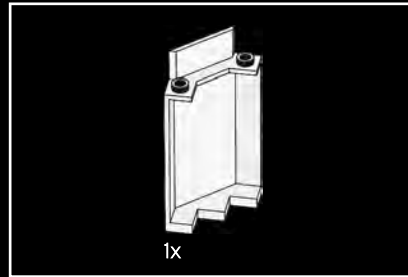
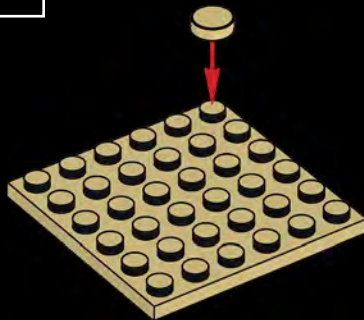

81





82

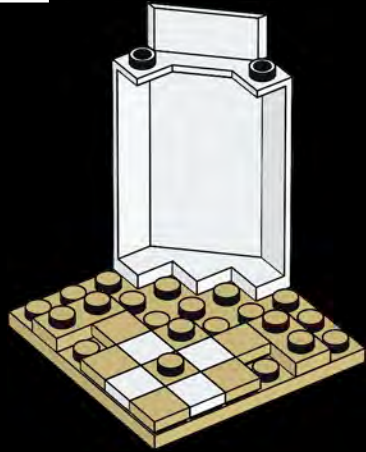

83

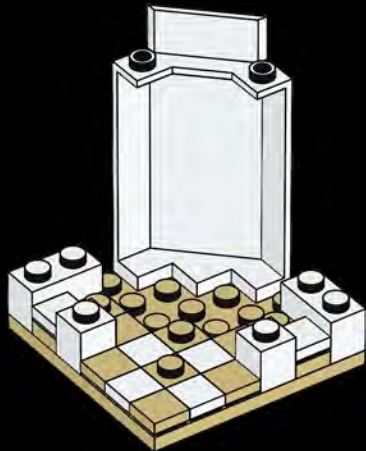

84

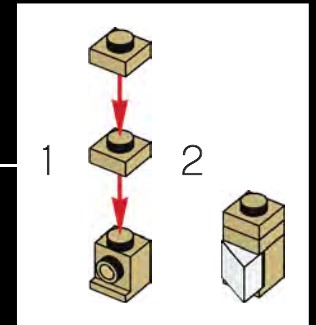
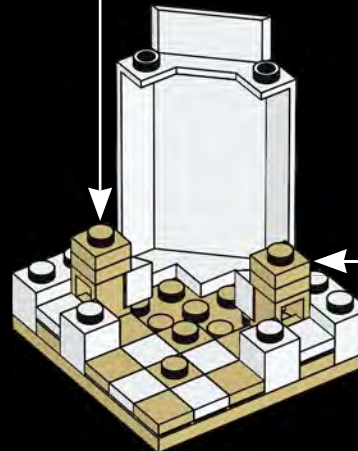
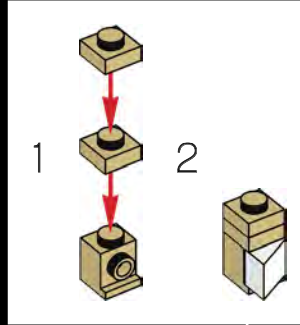



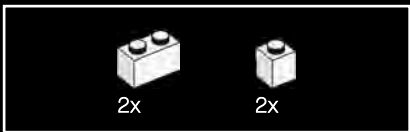

85

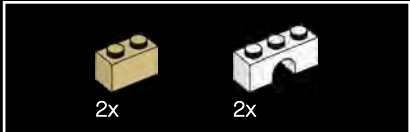
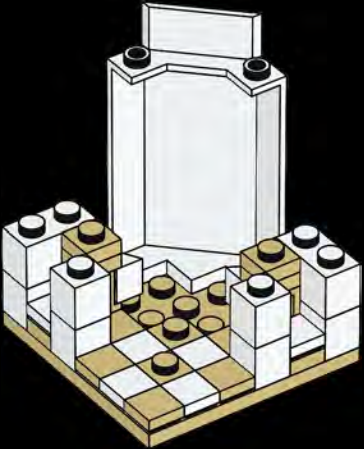

86

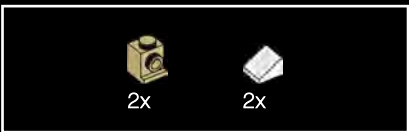
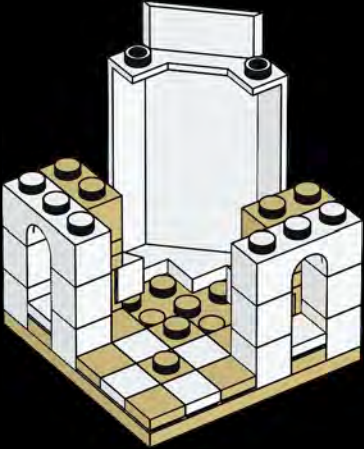

87

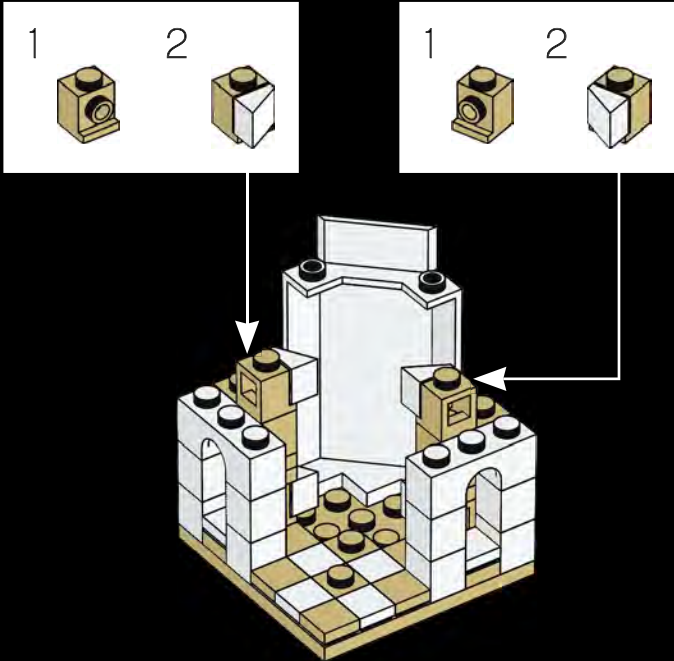



88

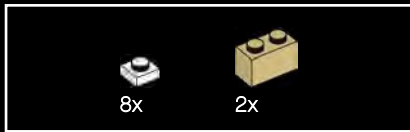
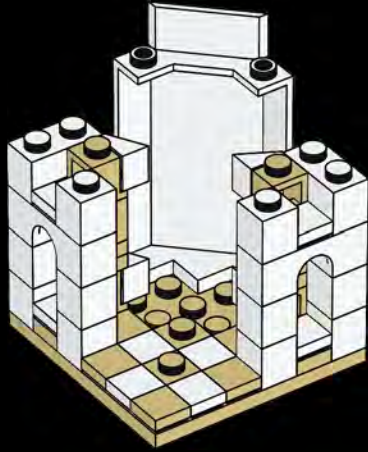

89

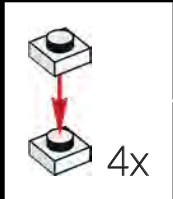

4x

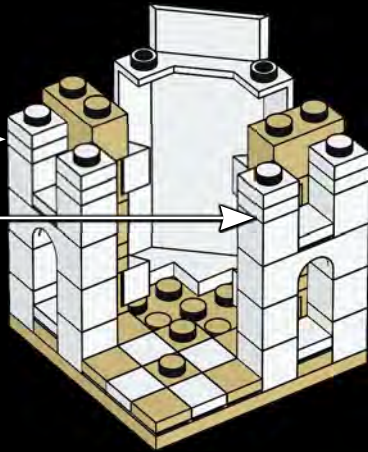

90

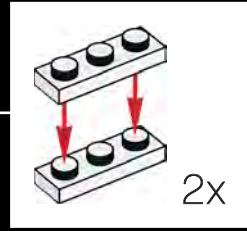
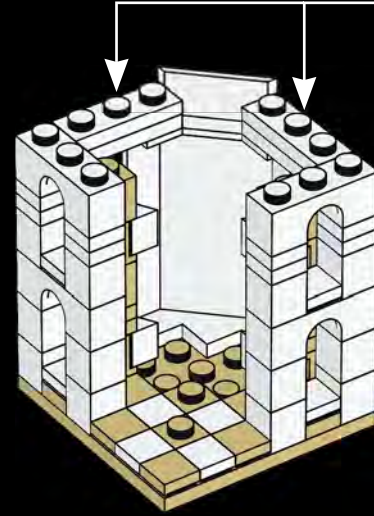

2x



91

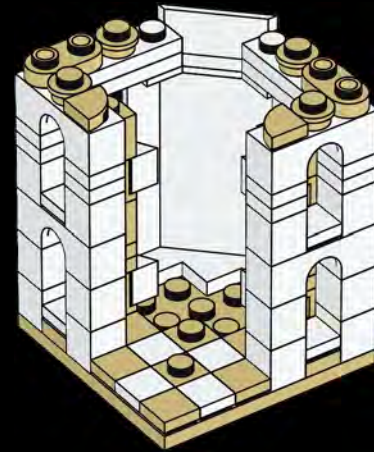





92

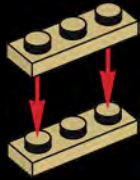

93



94

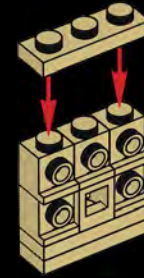

95





96

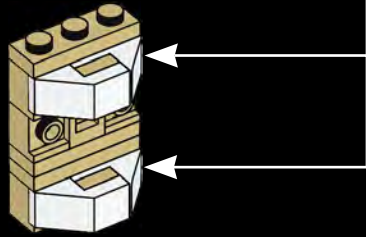
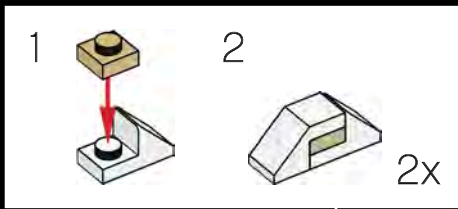

97

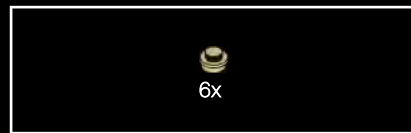
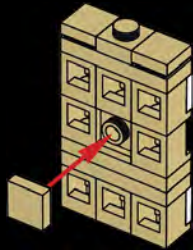

98



99

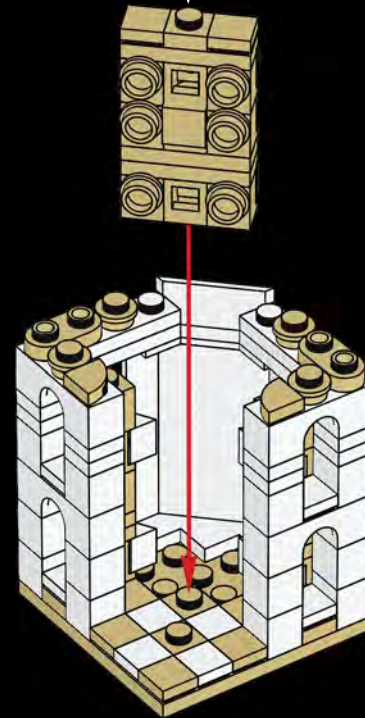



100

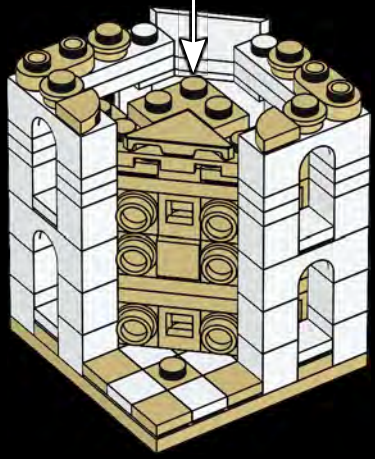
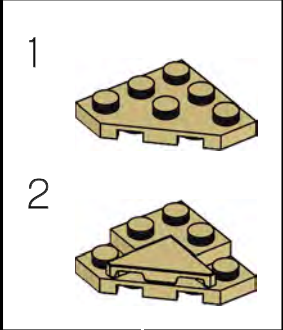

The Taj Mahal attracts 7-8 million visitors a year.  
Le Taj Mahal attire de 7 à 8 millions de visiteurs par an.  
El Taj Mahal atrae de 7 a 8 millones de visitantes al año.







101

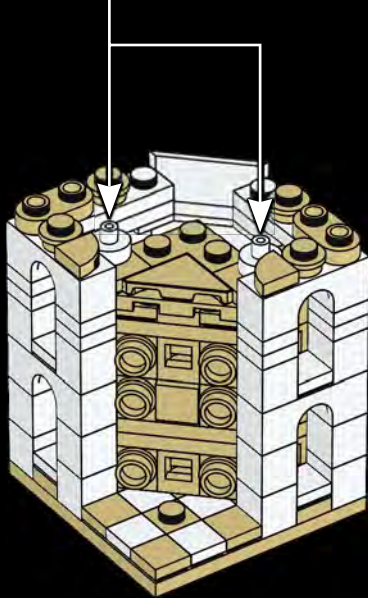
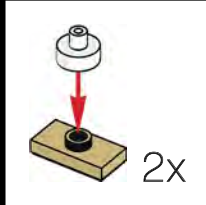

102

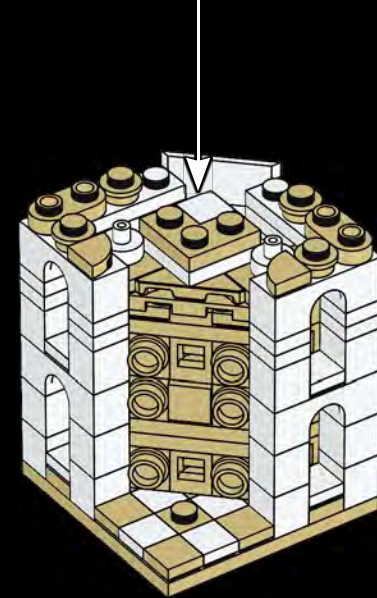
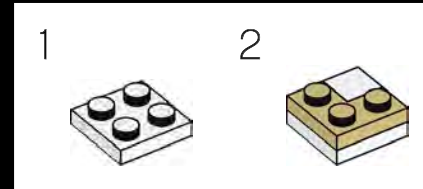

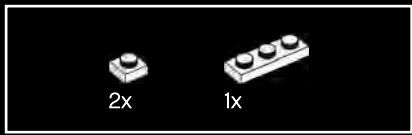

103



104

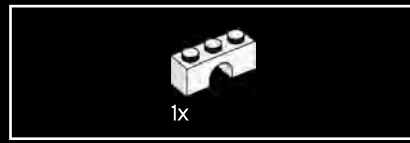

105



106





107

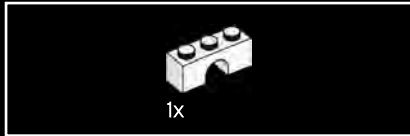
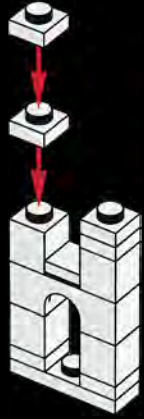

108

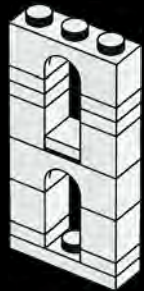

109

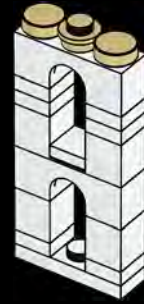

110

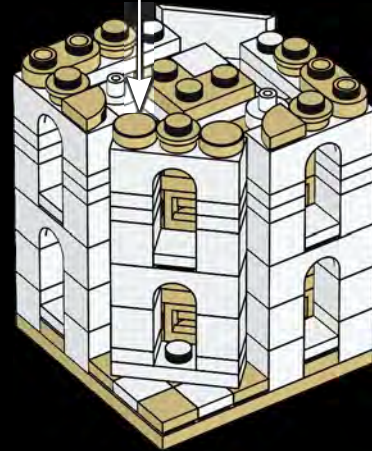





111

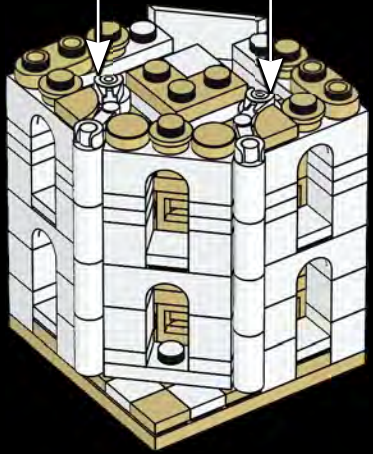
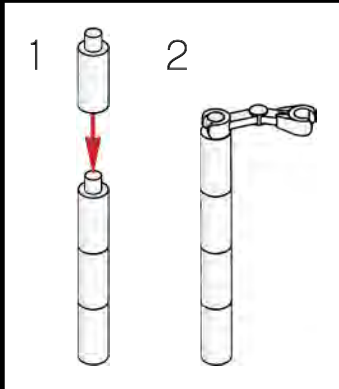
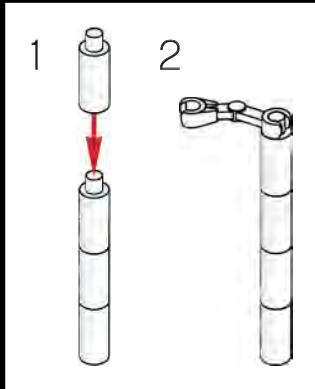

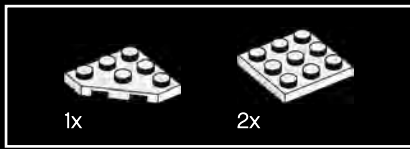

112

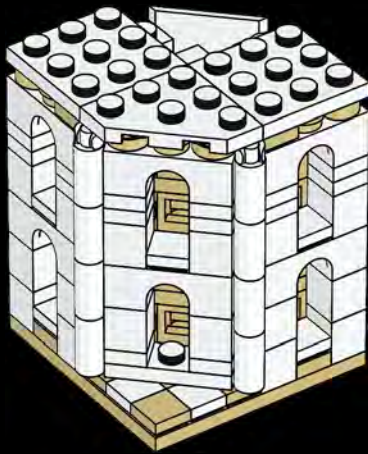

113

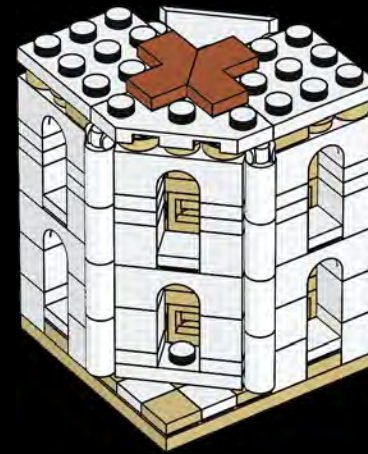

2x

114





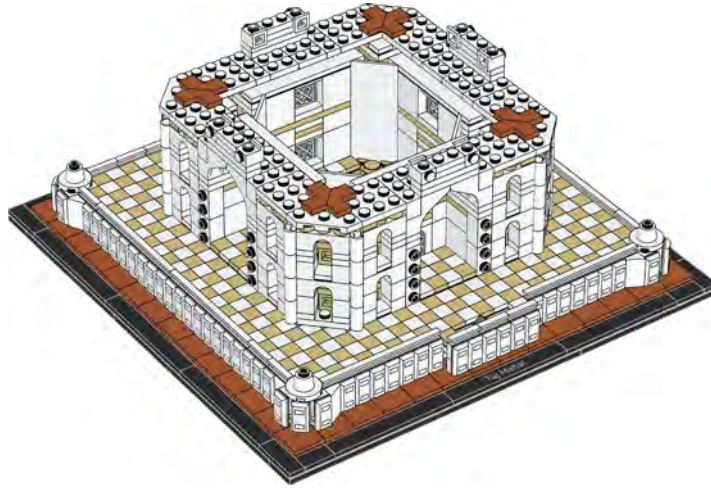
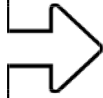

2x

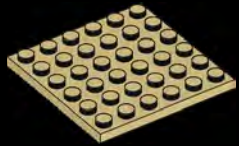

1x



1x

115

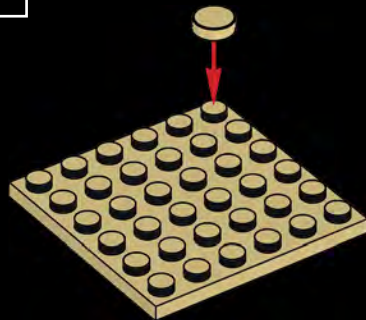

1x

116





117

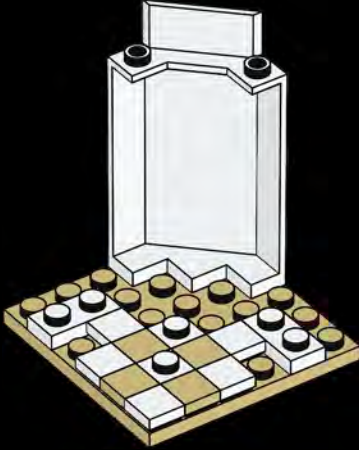

118

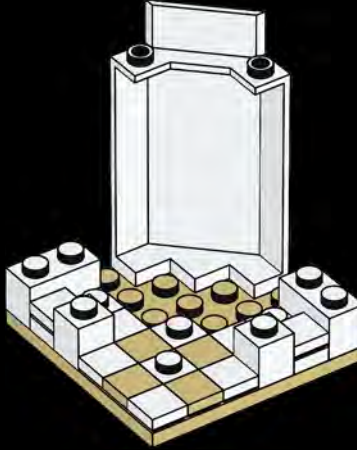



119

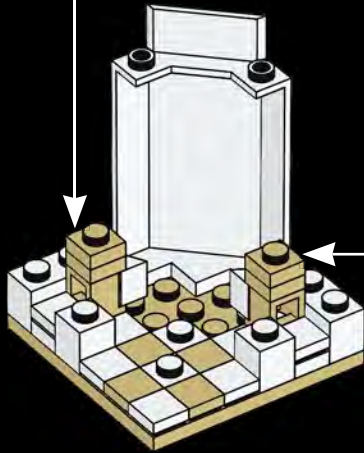
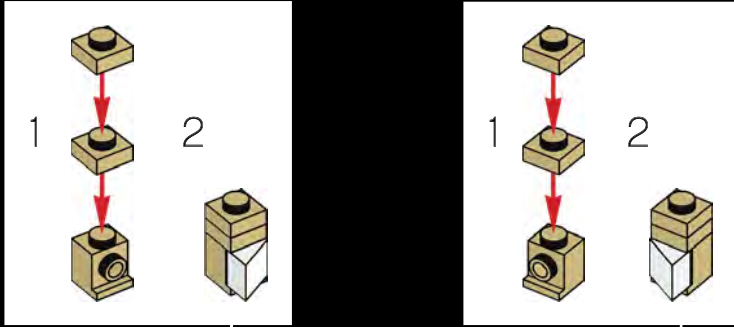

120

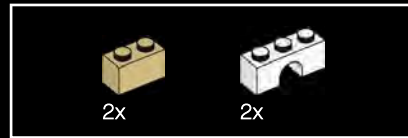
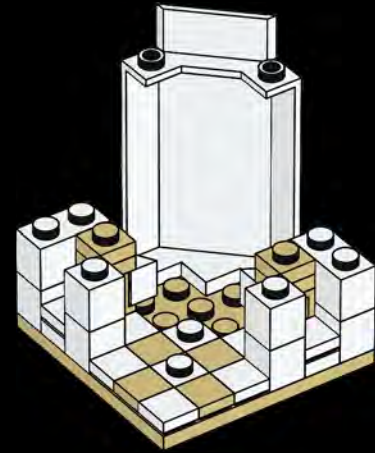

121

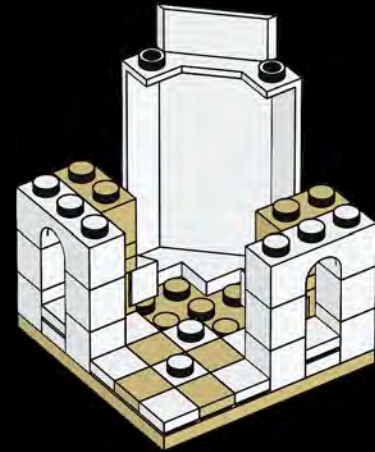





122

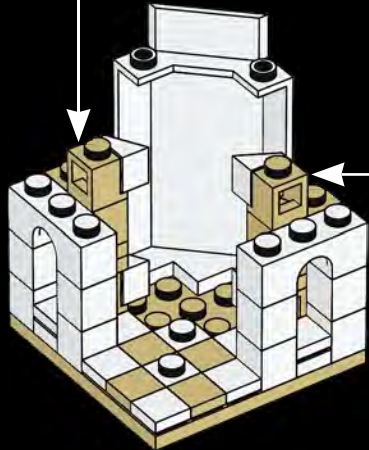
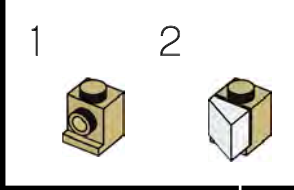
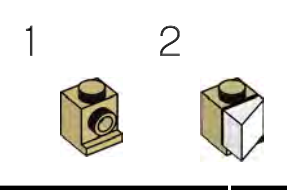

123

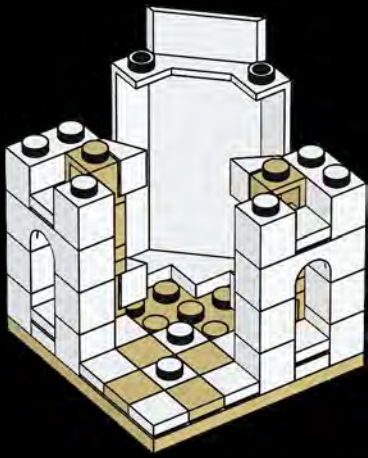

124

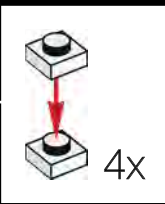
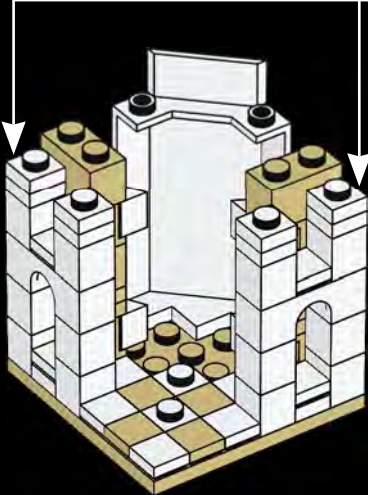

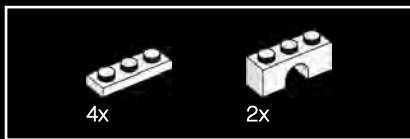

125

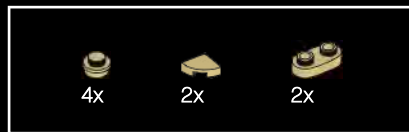
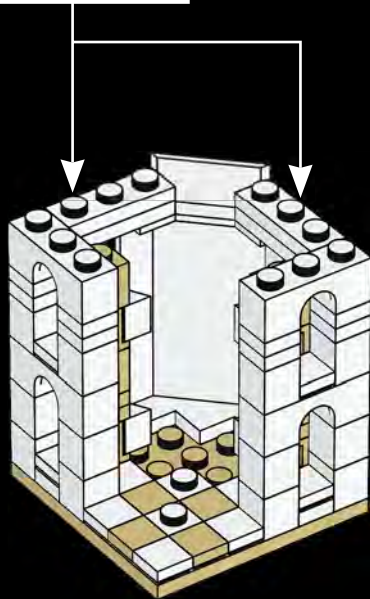
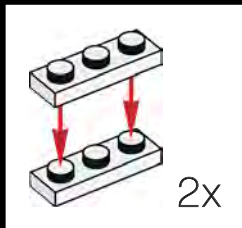

126

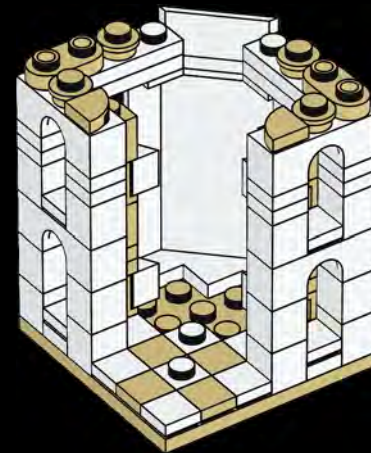



127

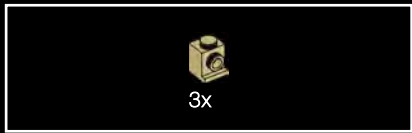
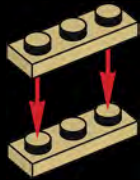

128

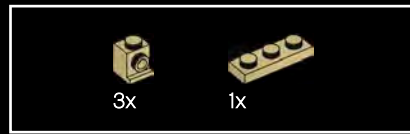

129

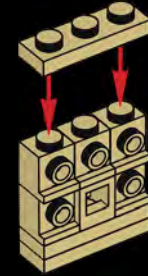

130

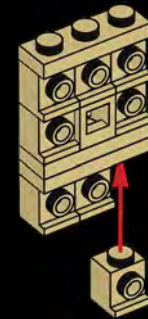





131

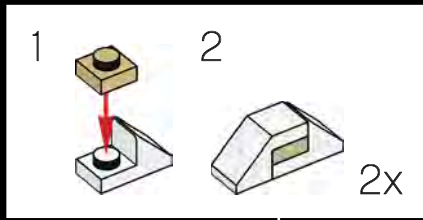

132

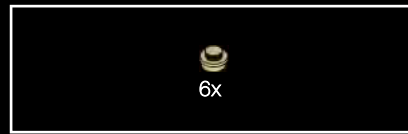
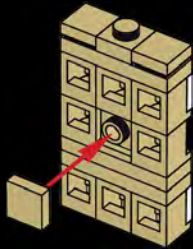

133



134

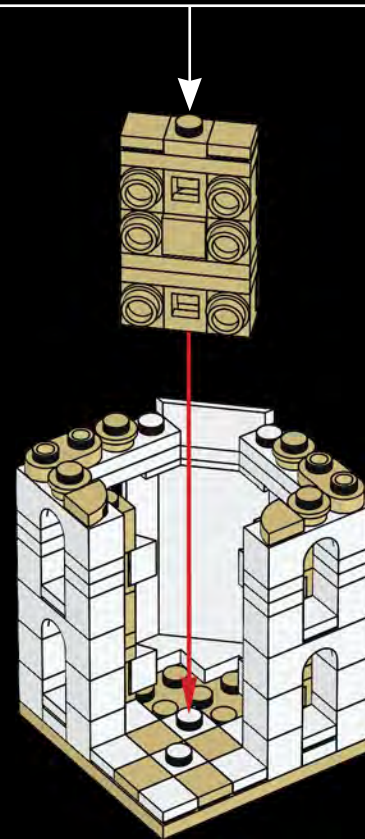



135

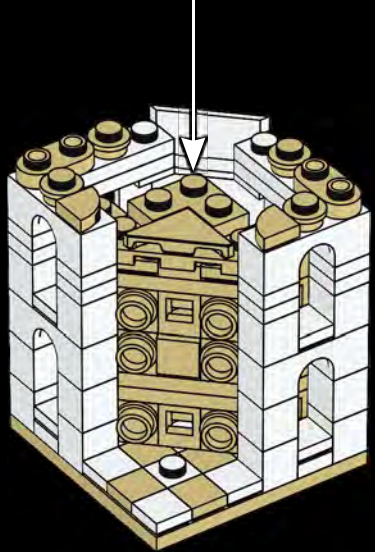
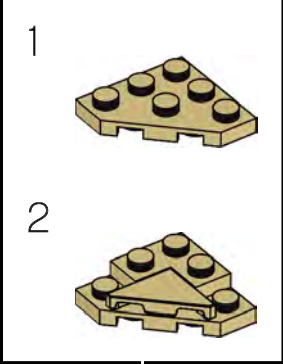



136

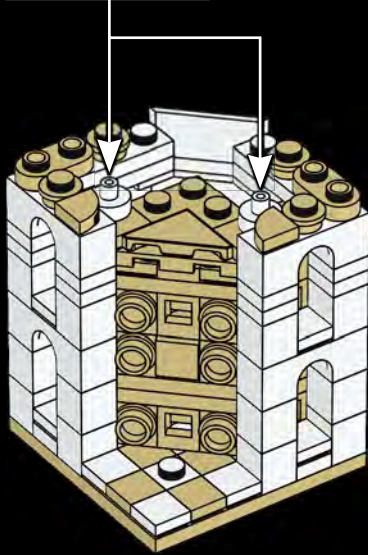
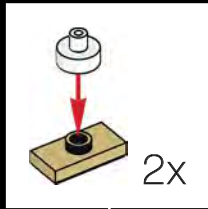

137

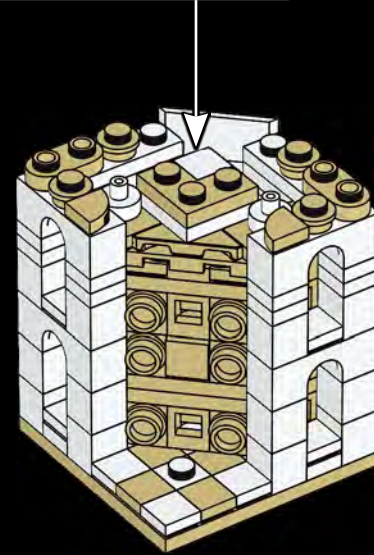
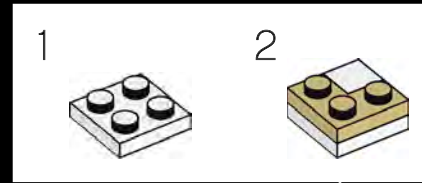



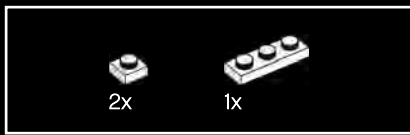

138



139

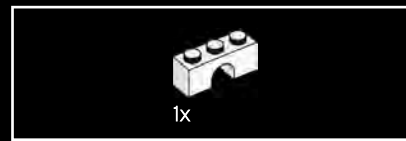

140

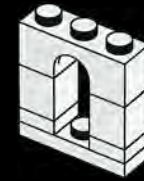

141





142

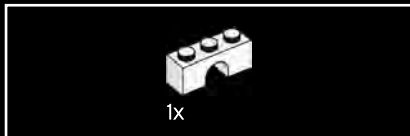
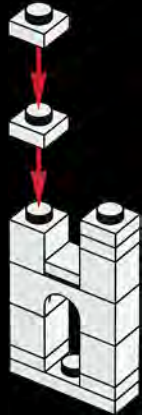

143

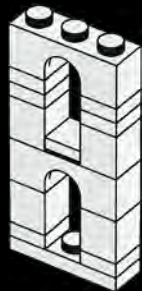

144

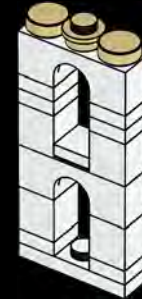

145

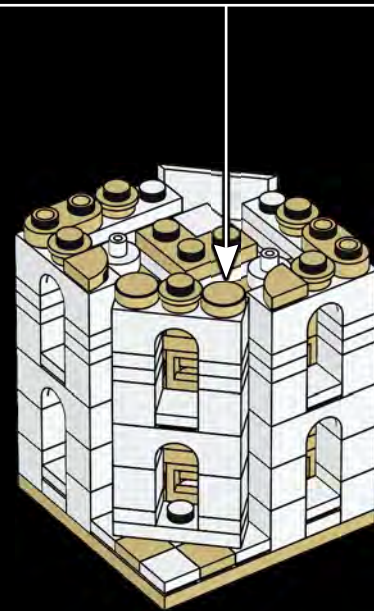



146

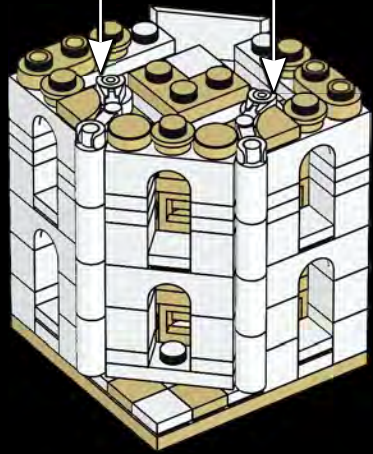
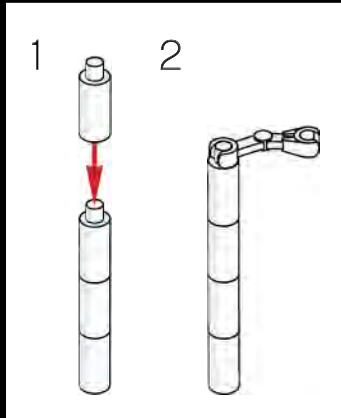
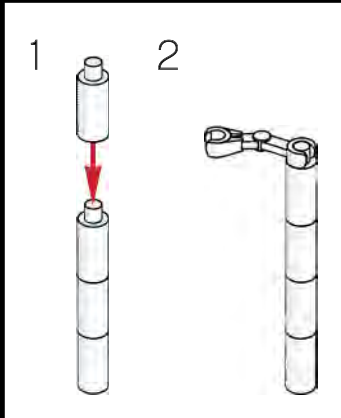



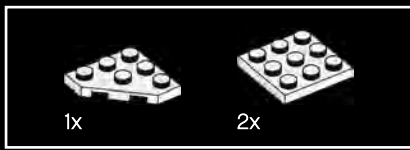

147

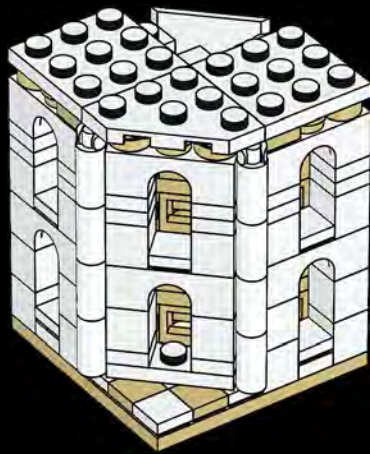

148

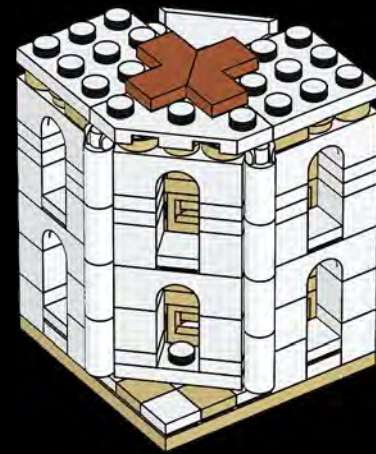

2x

149

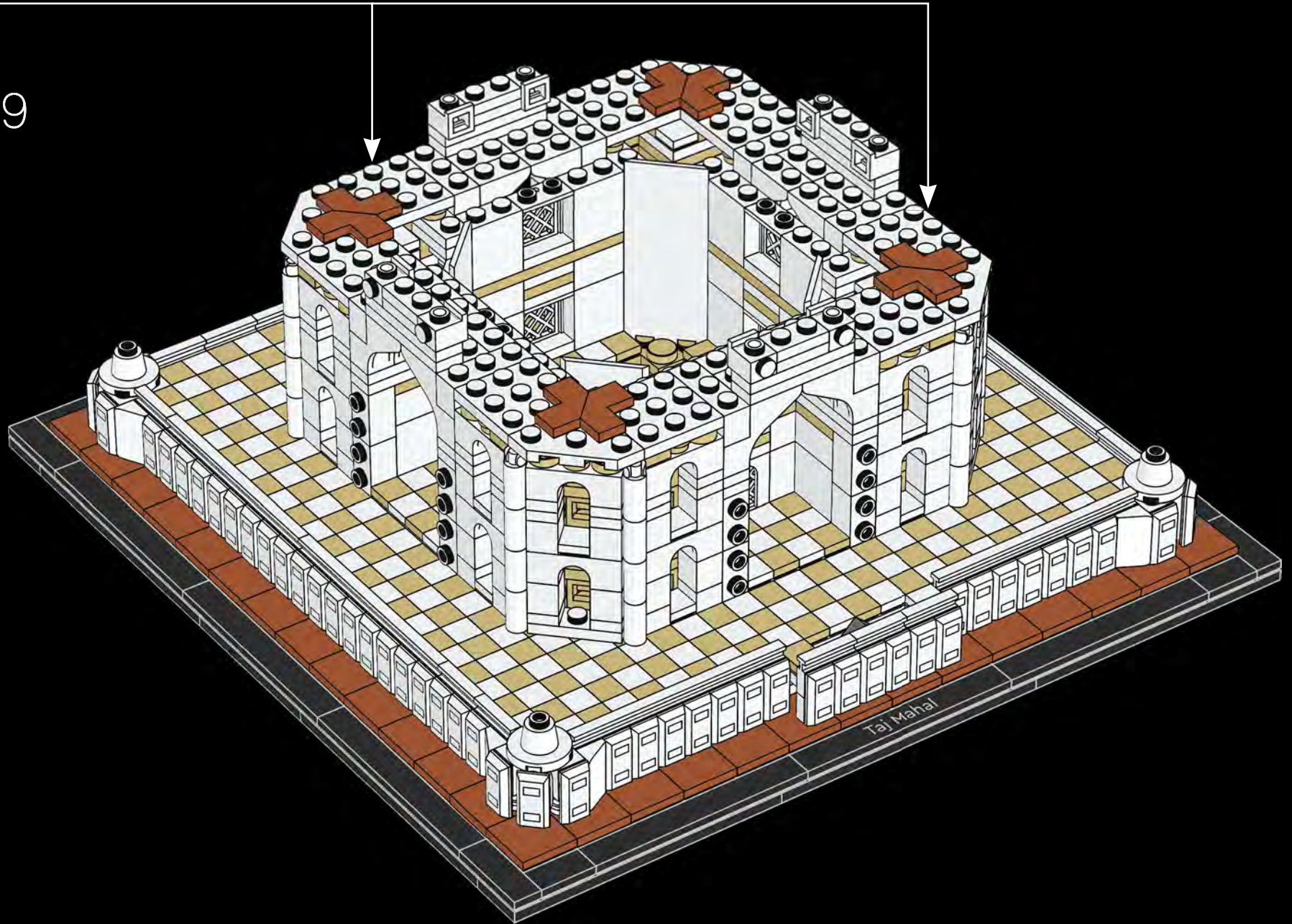



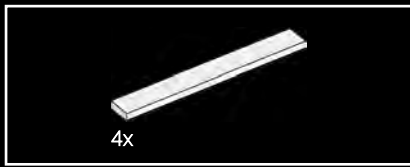

150





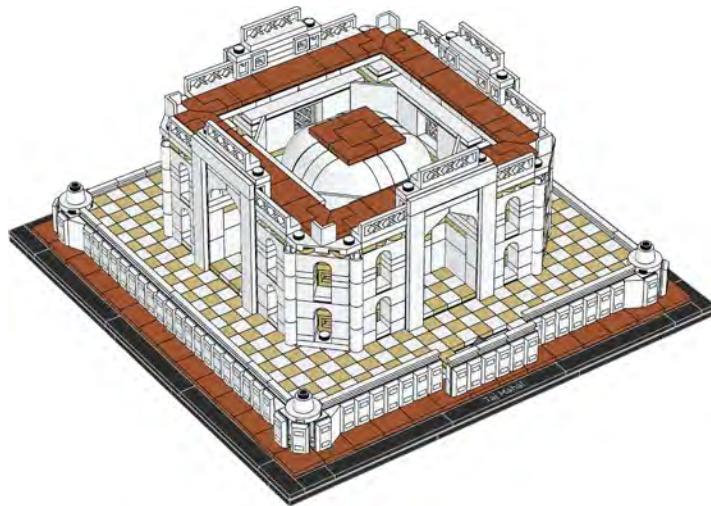
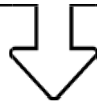

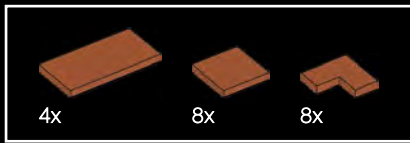

151

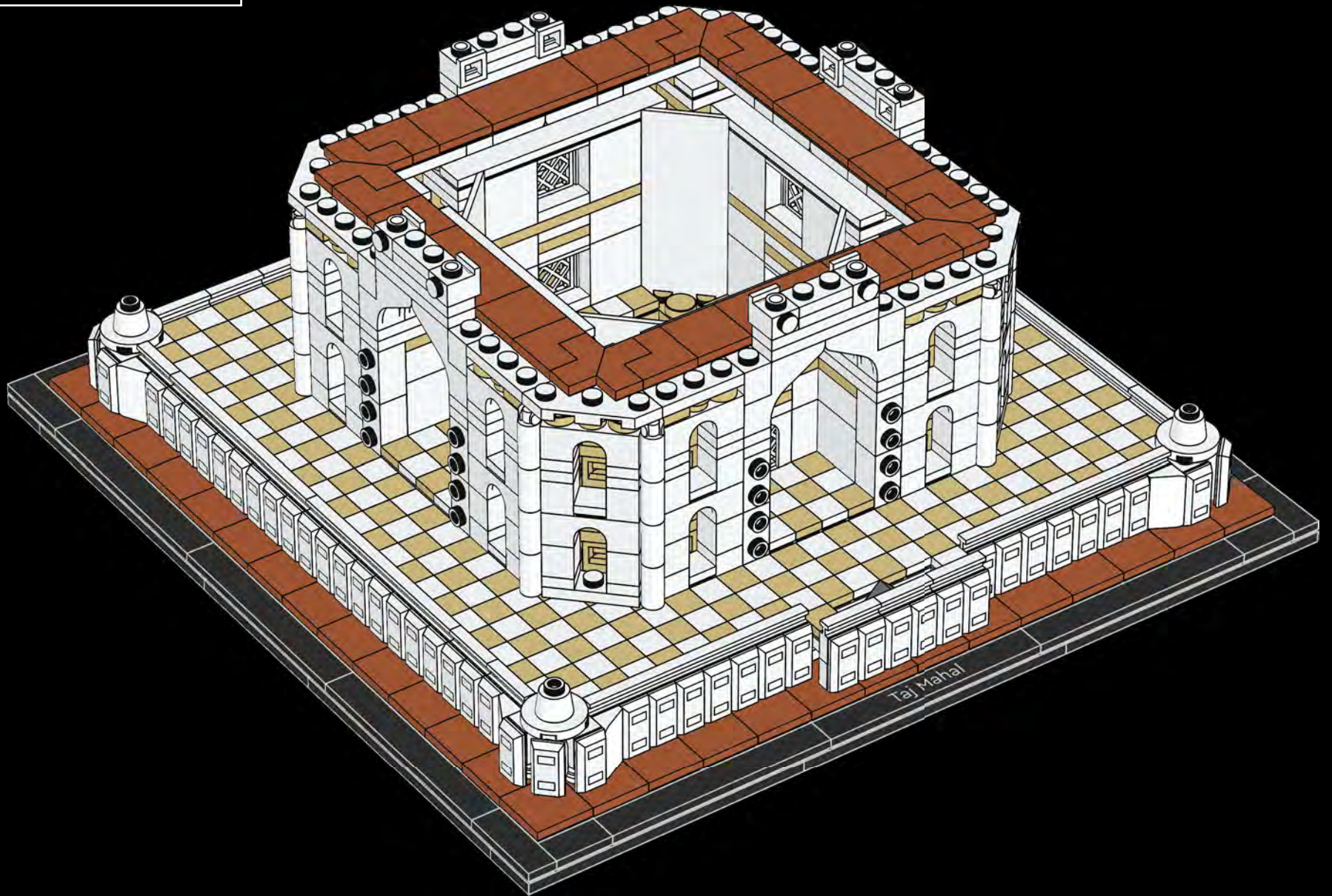



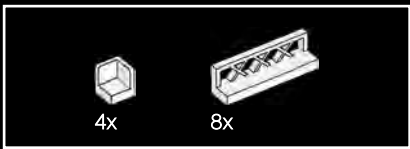

152

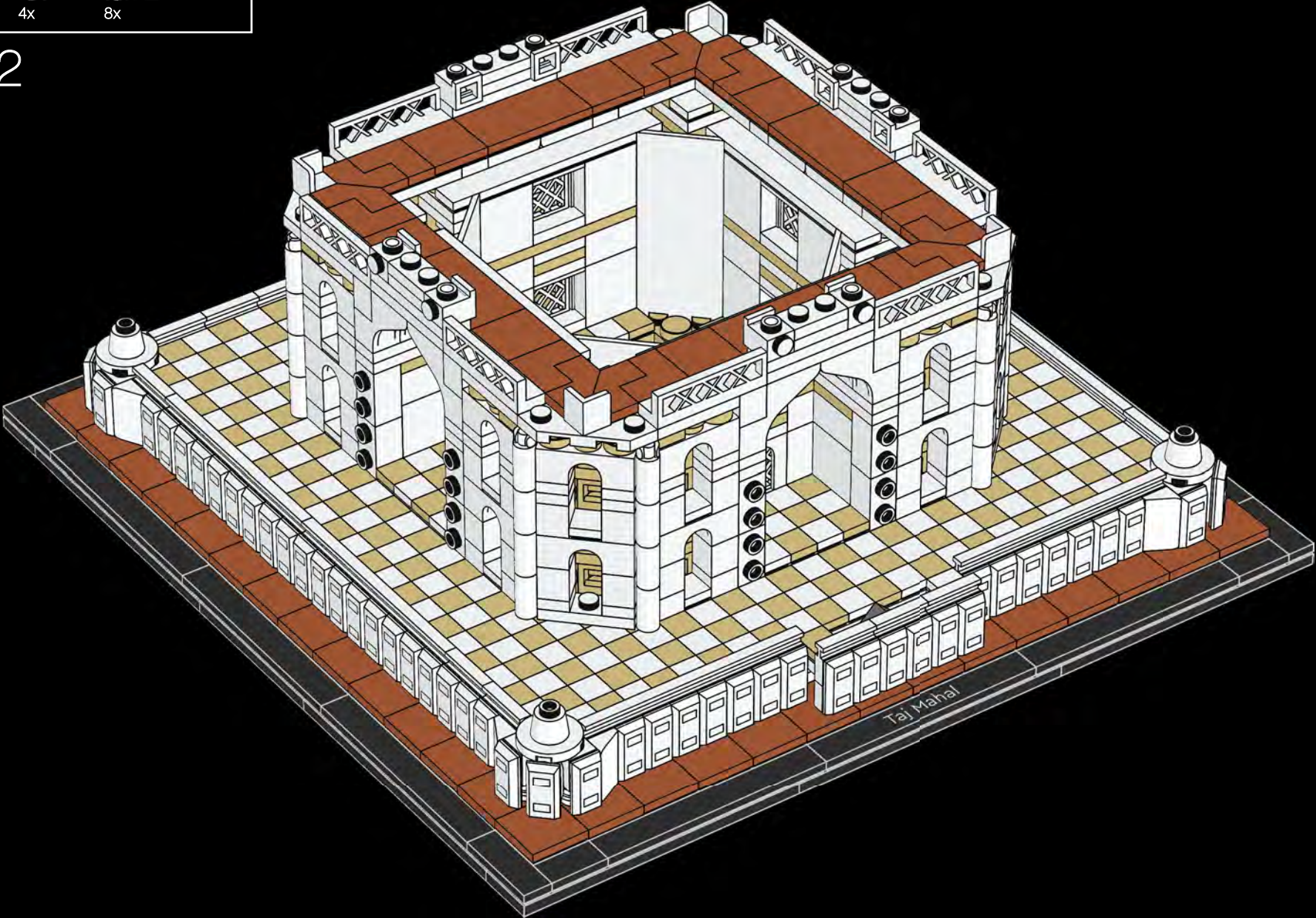



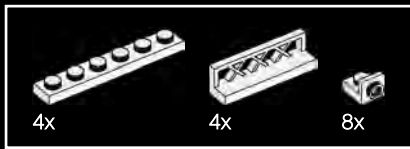

153

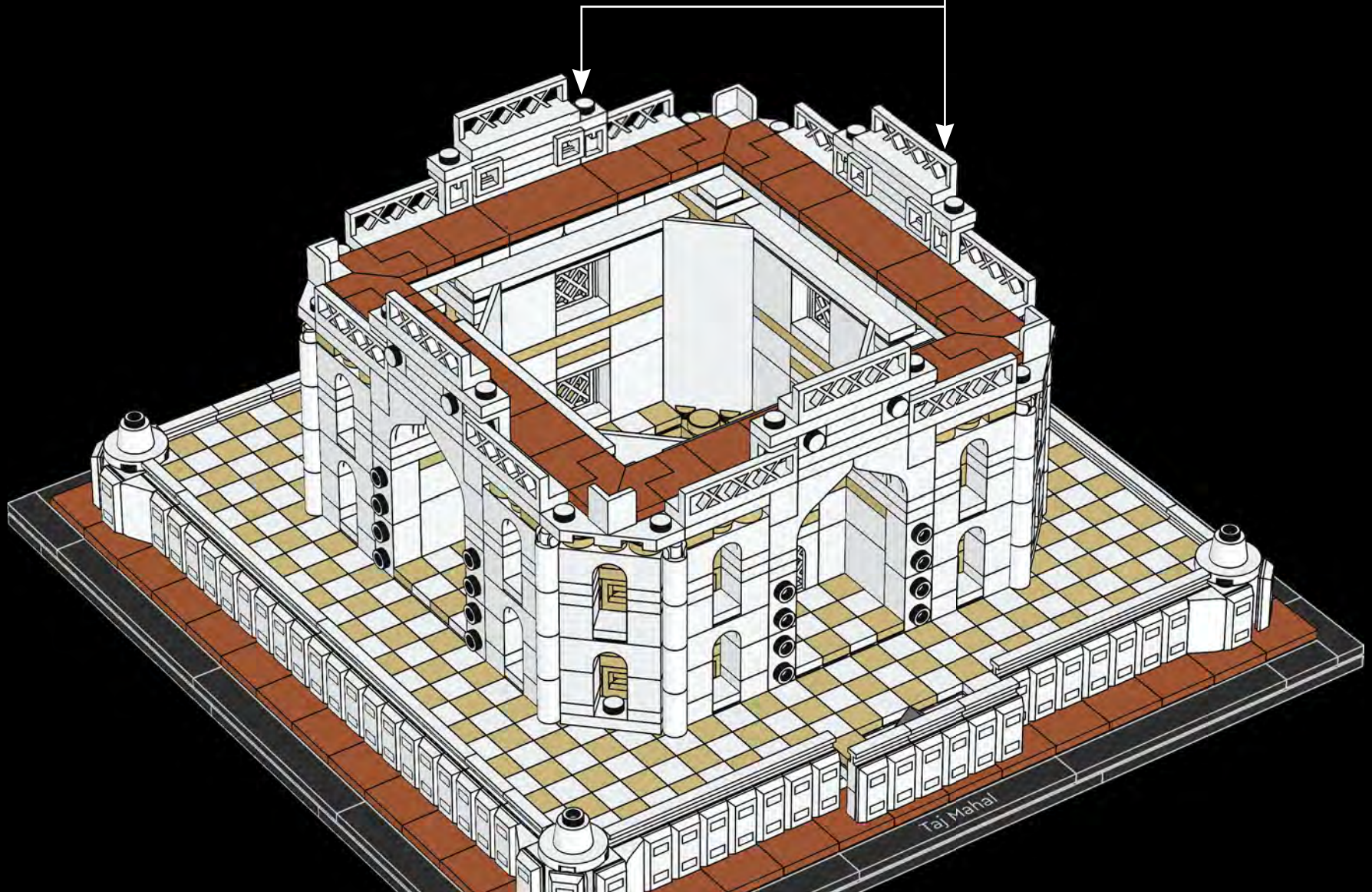
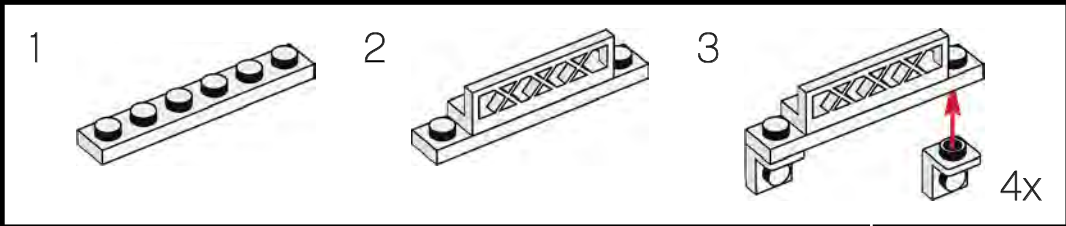



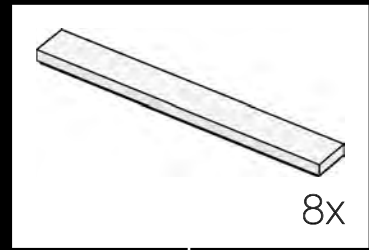
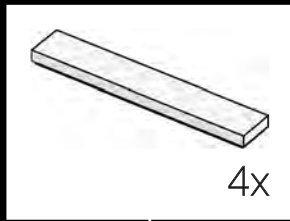
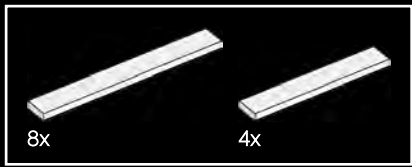

154

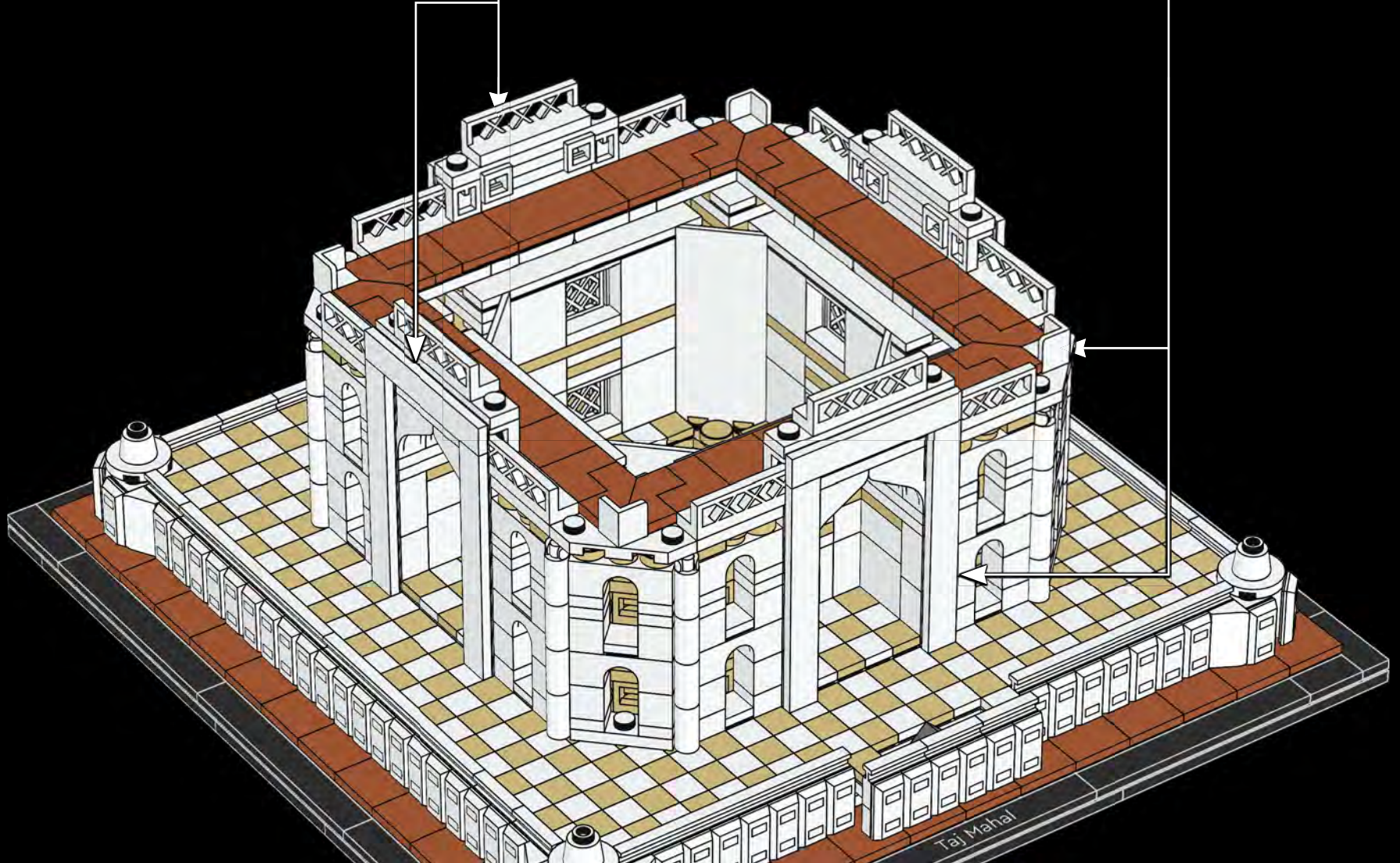

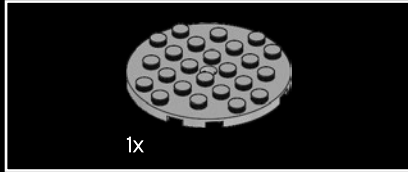

155

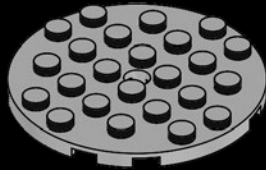

156

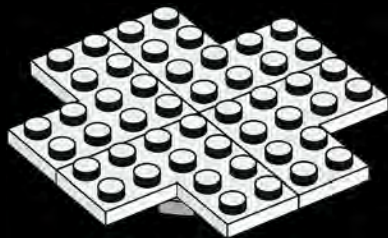

157

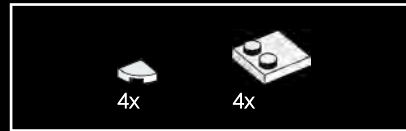

158

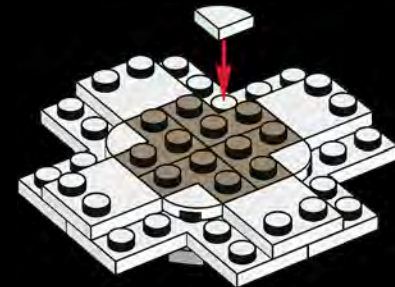





159

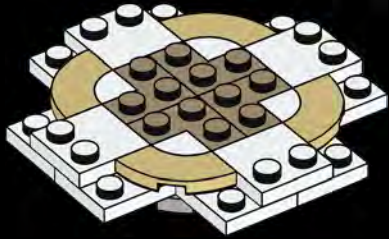

160

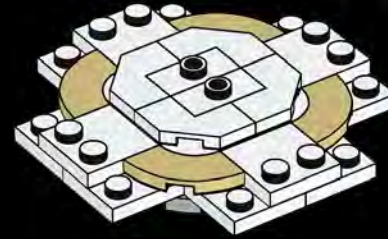



161

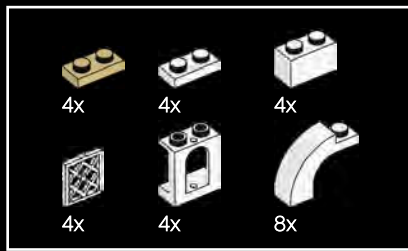
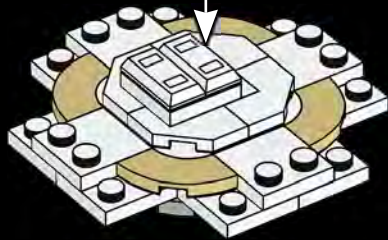
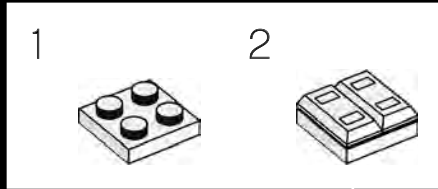

162

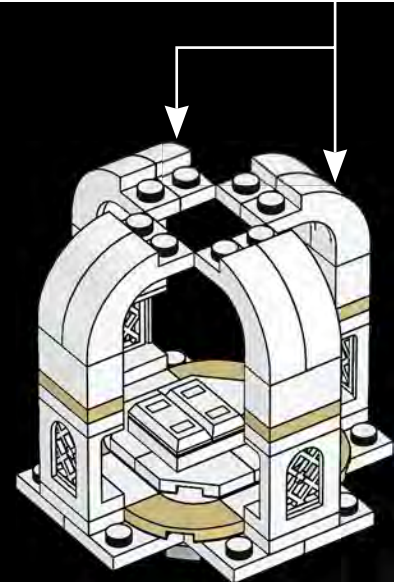
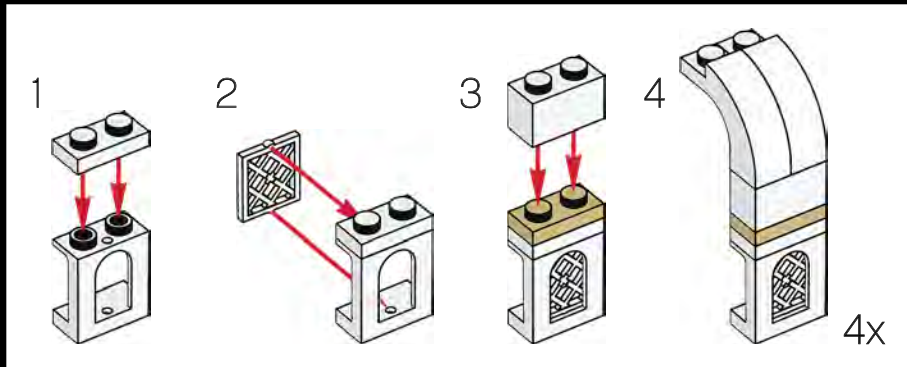

Shah Jahan's cenotaph is beside Mumtaz's and is the only visible asymmetric element in the entire complex.

Le cénotaphe de Shâh Jahân se trouve à côté de celui de Mumtaz et est le seul élément asymétrique visible dans l'ensemble du complexe.

El cenotafio de Shah Jahan está junto al de Mumtaz y es el único elemento asimétrico visible en todo el complejo.



163

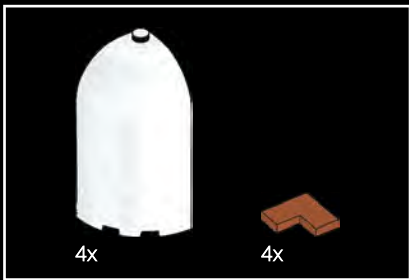
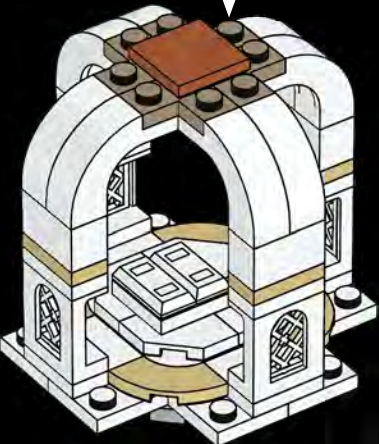

164

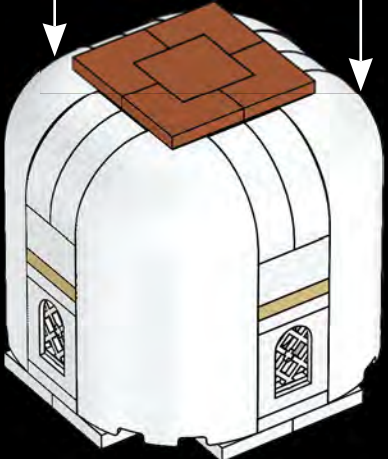
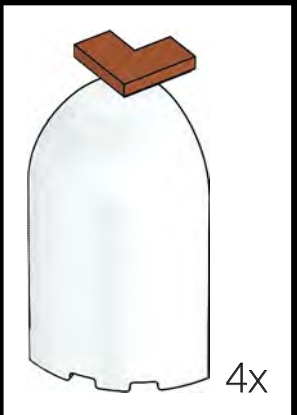



165

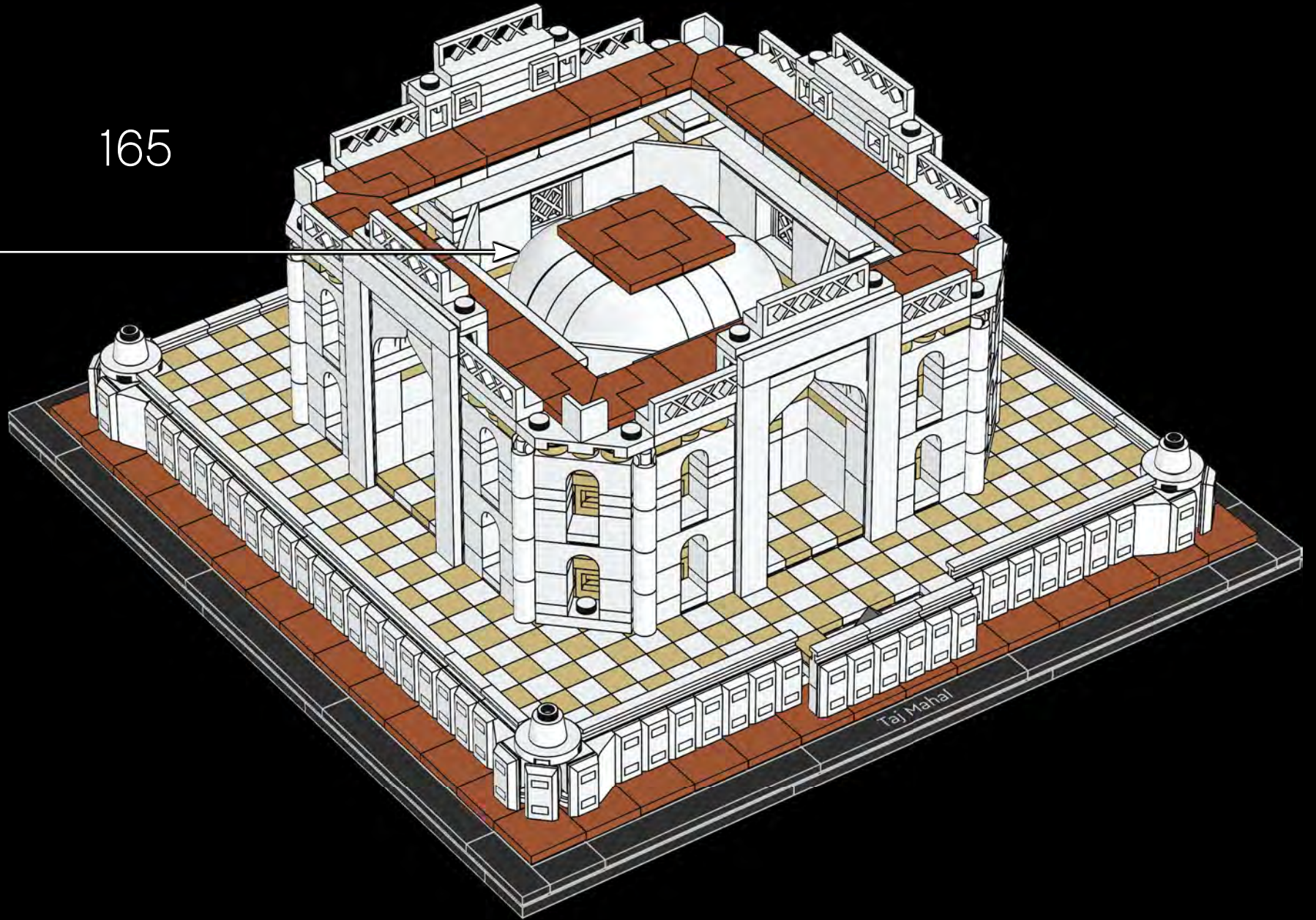

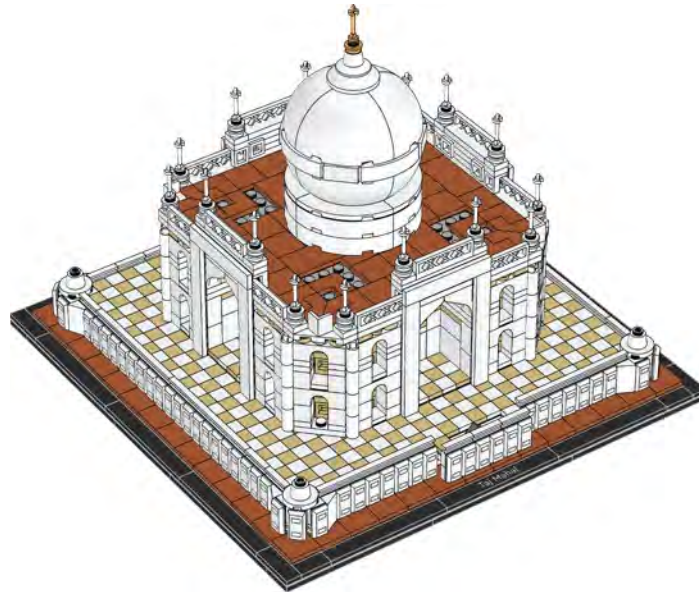
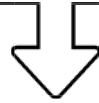

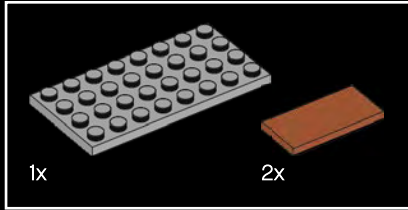

166

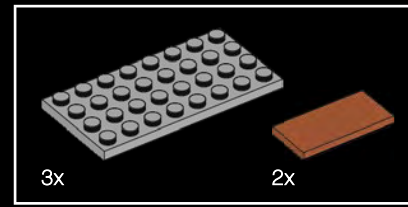
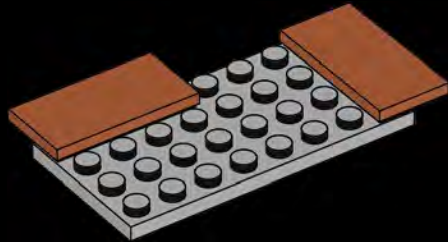

167

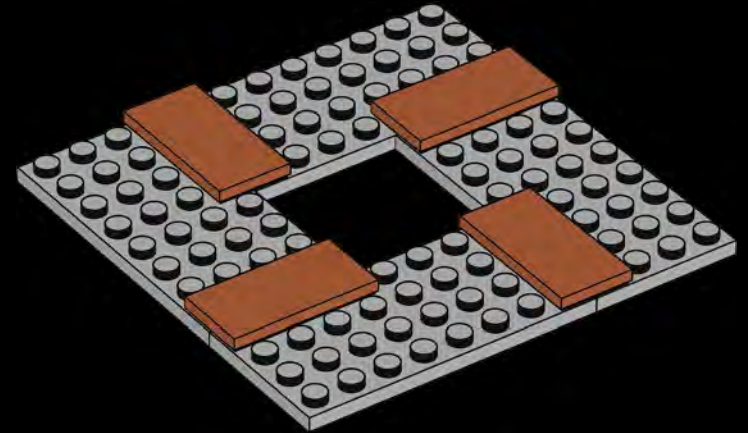



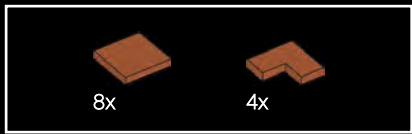

168

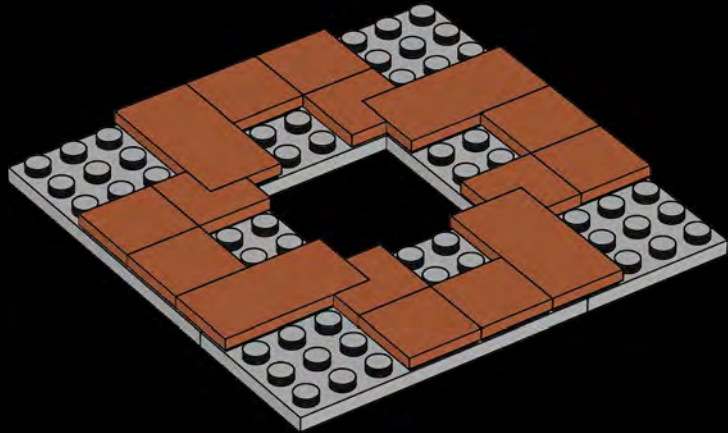

169

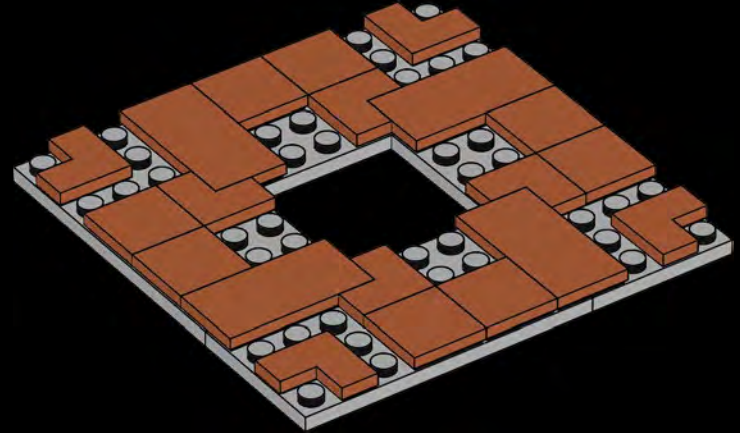

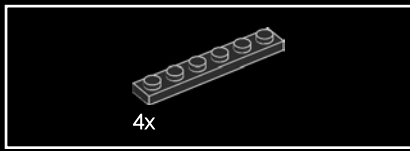

170

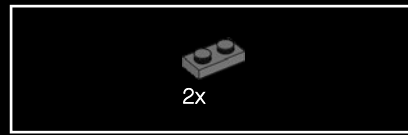
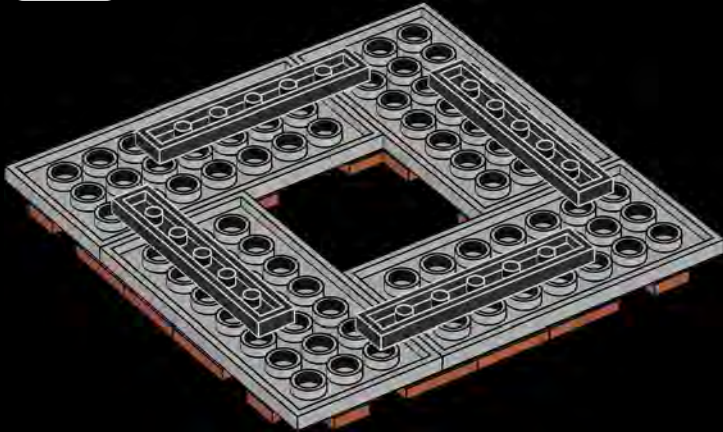

171

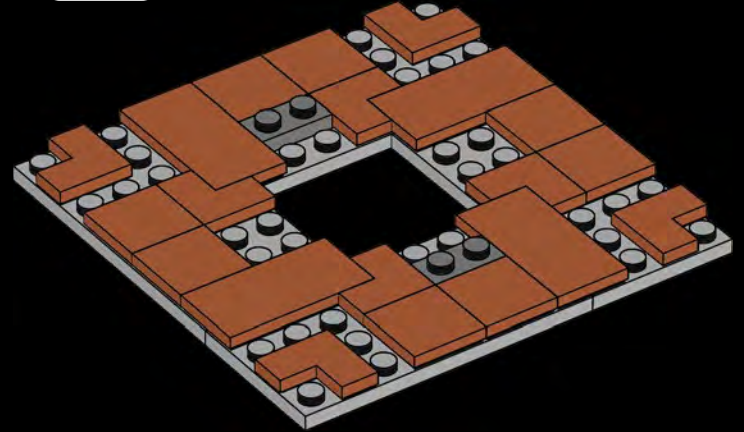



172



173



174

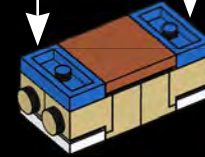
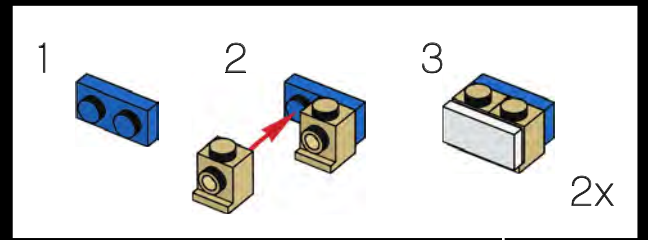

175

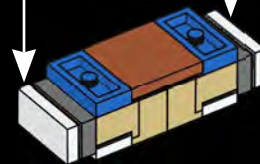
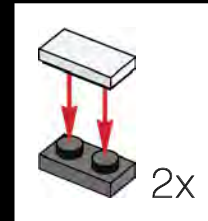



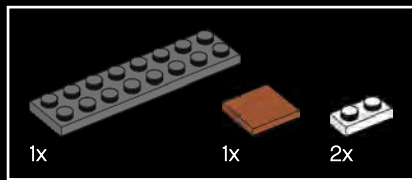

176

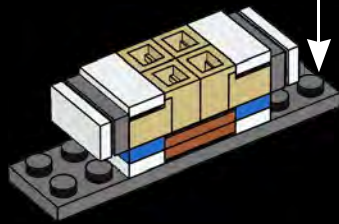
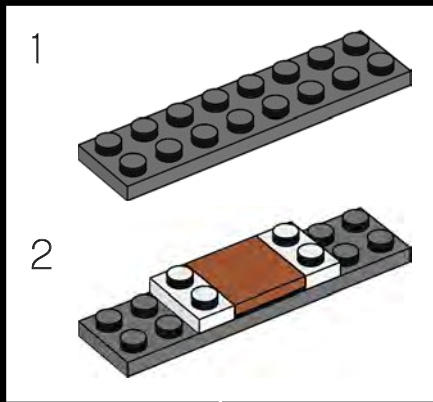

177

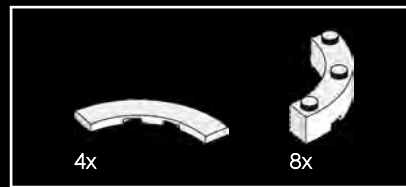
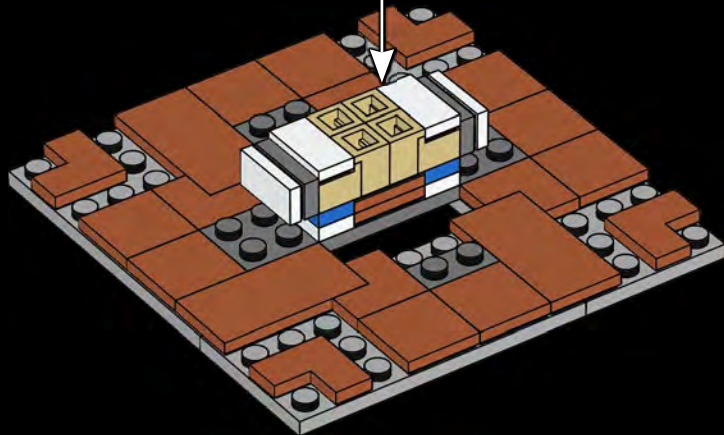

178

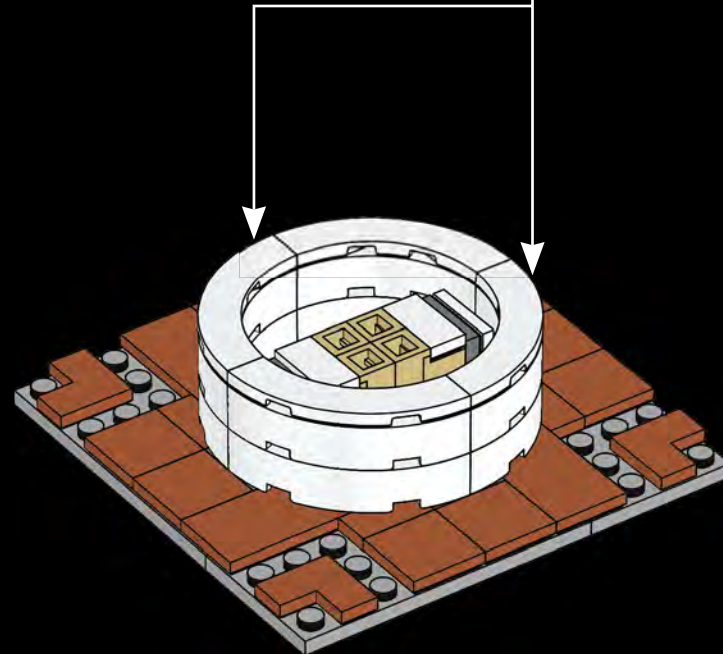
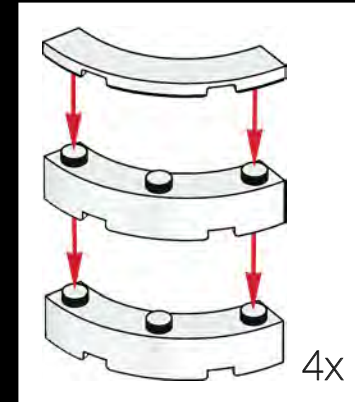

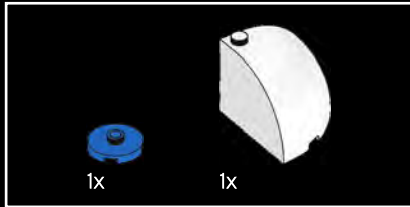

179

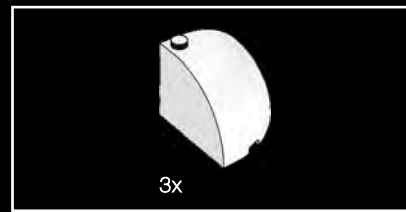
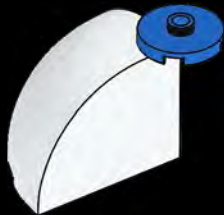

180

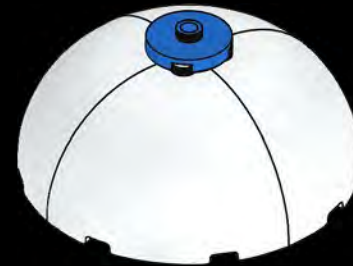

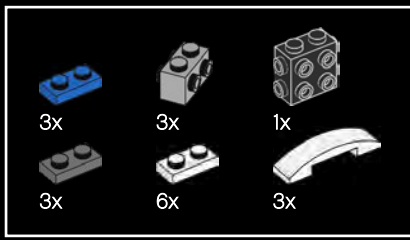

181

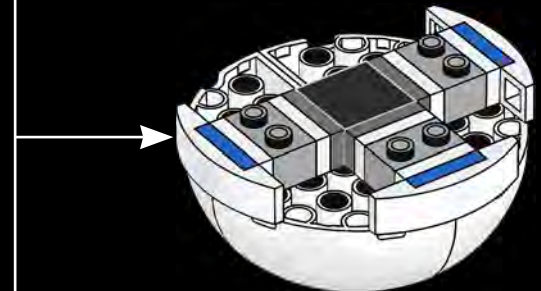
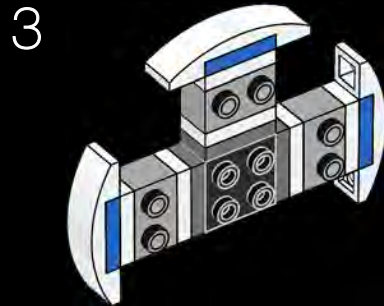
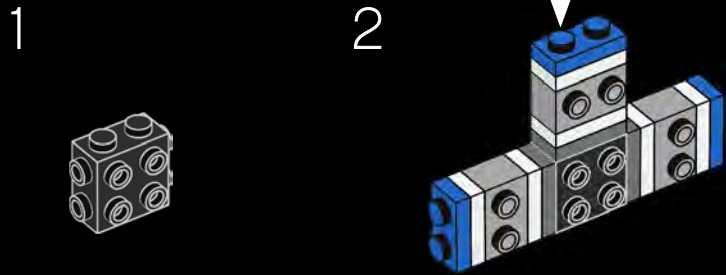
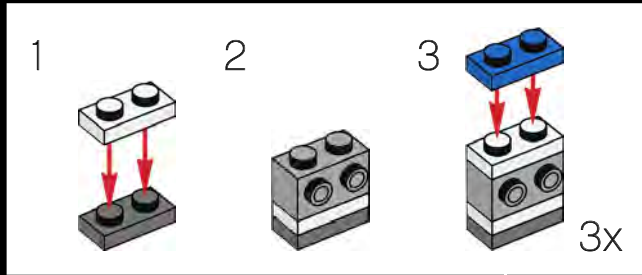



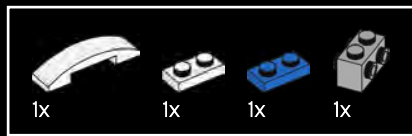

182

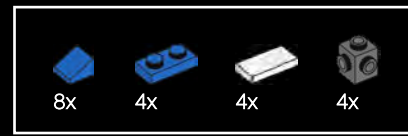
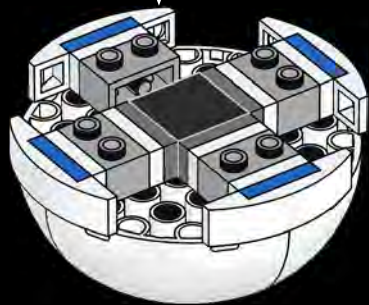
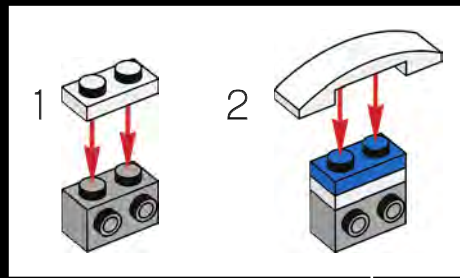

183

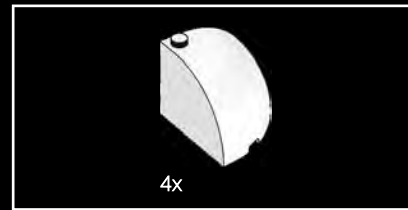
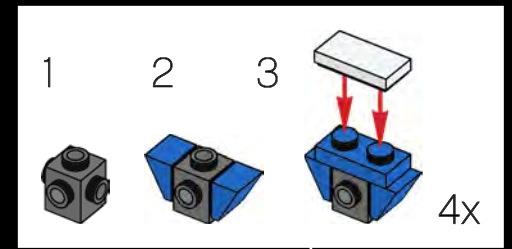

184

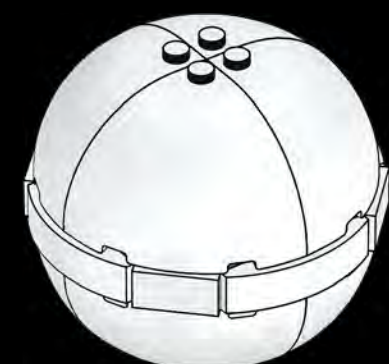

185

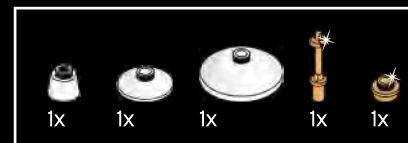
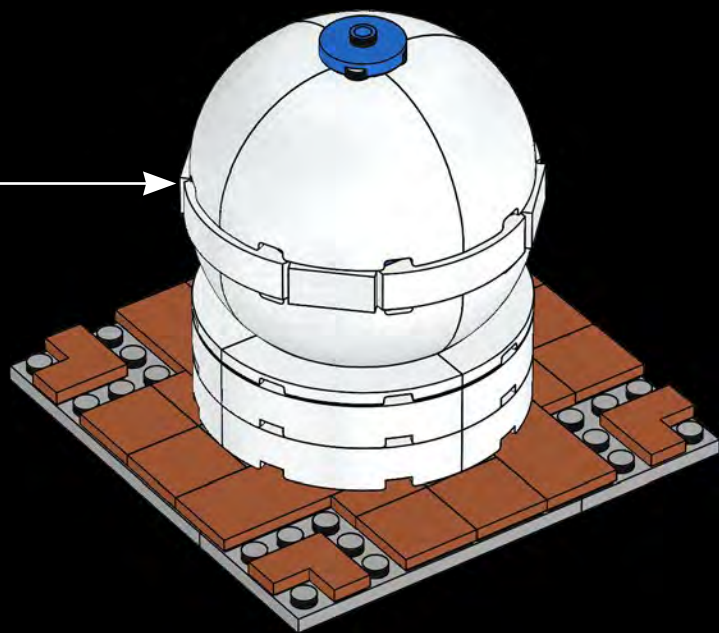

186

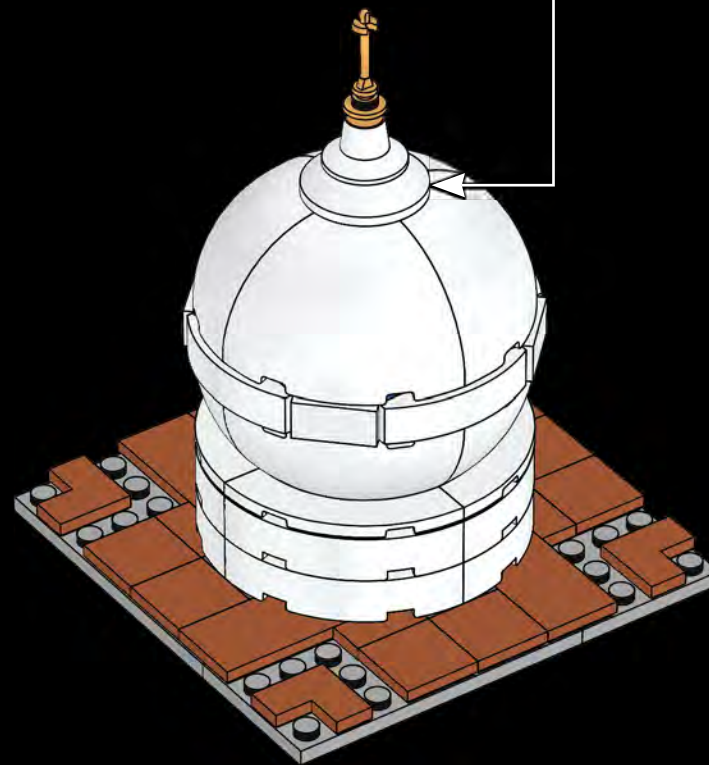
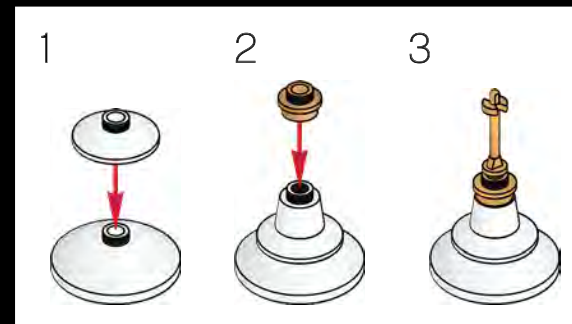

187

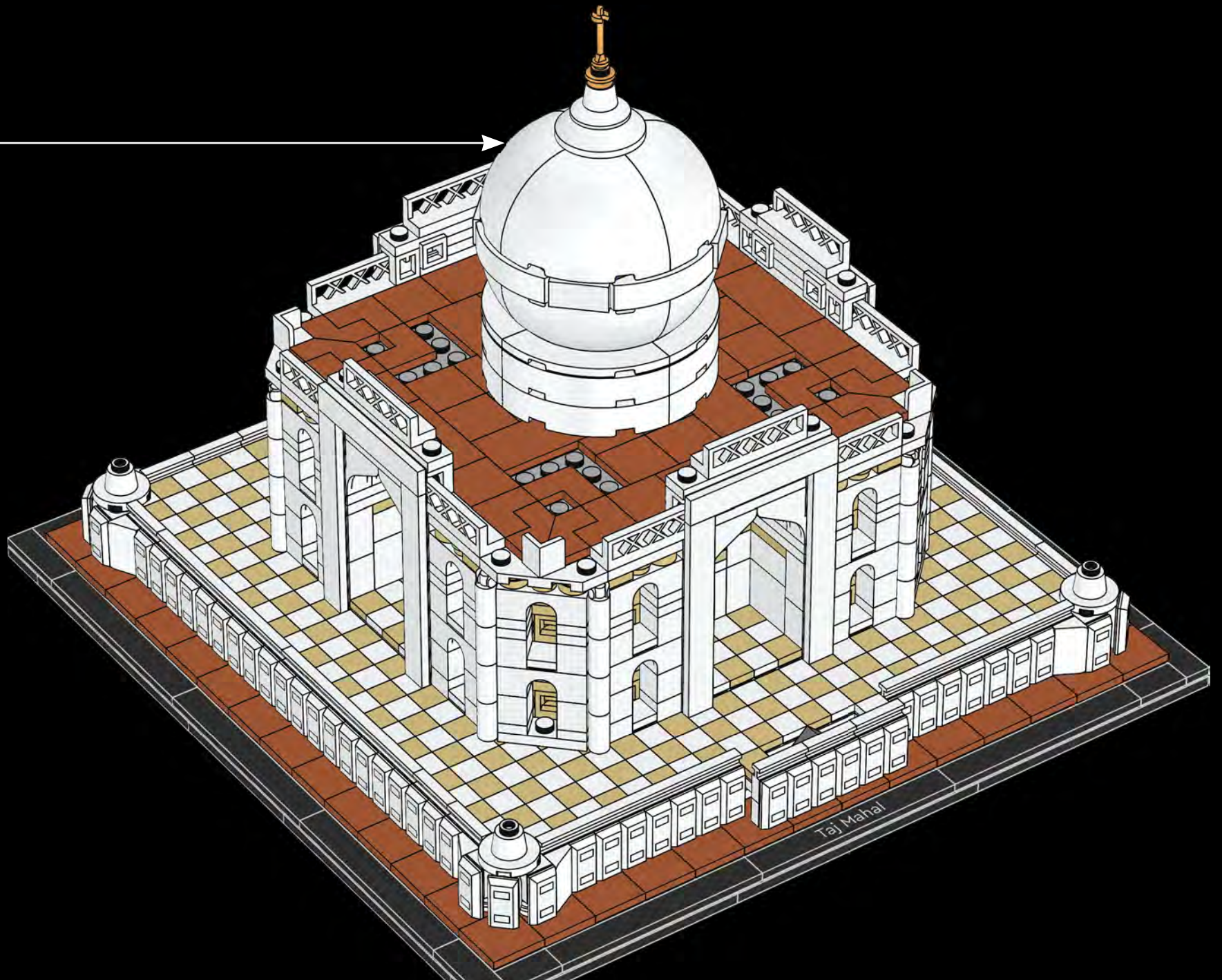



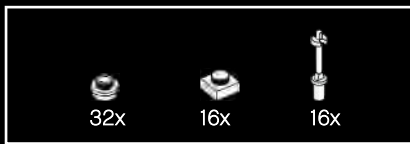

188

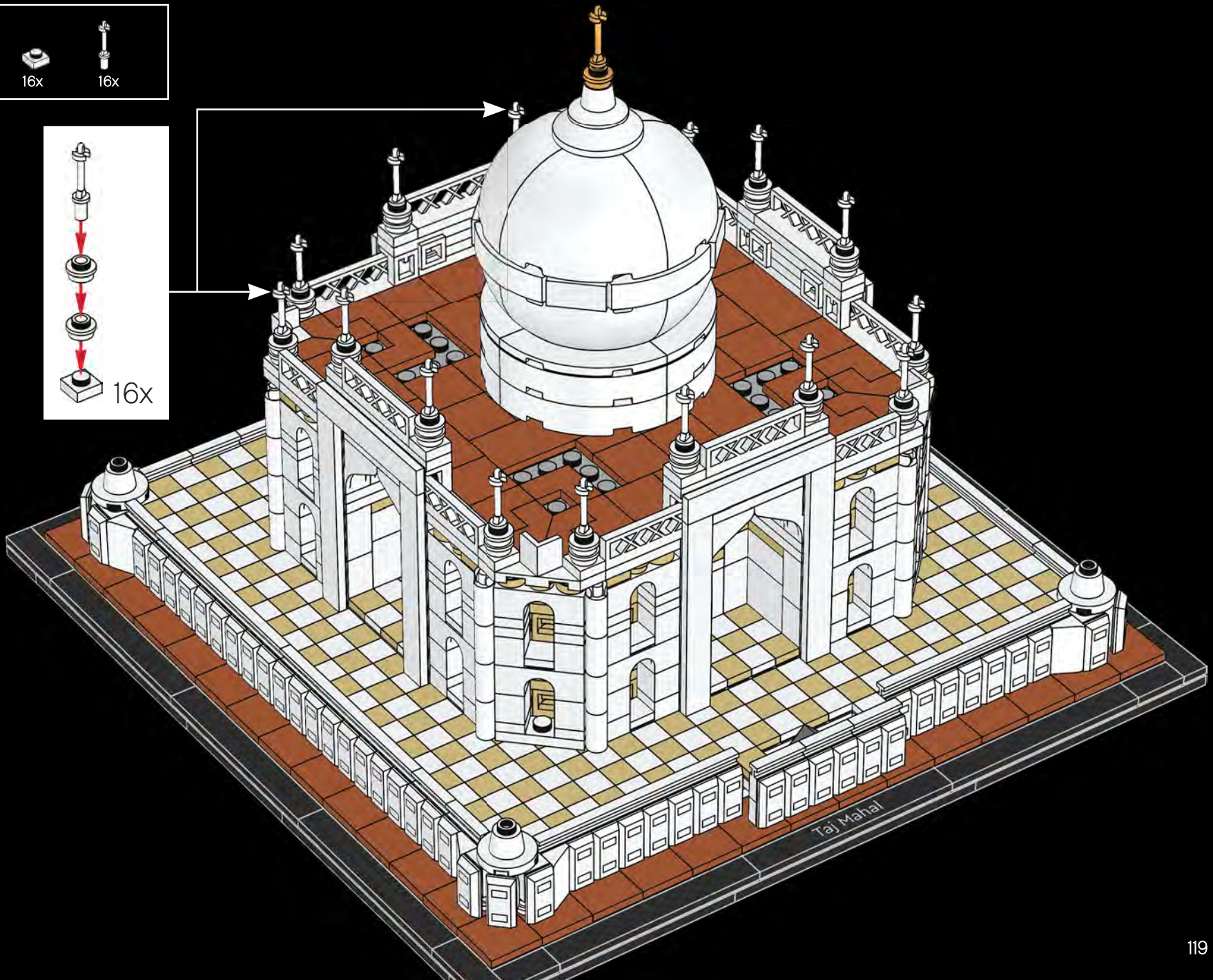
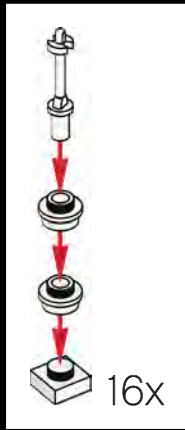

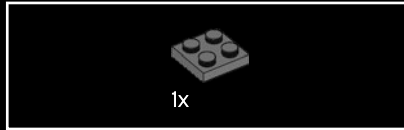
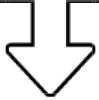

189

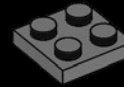



190

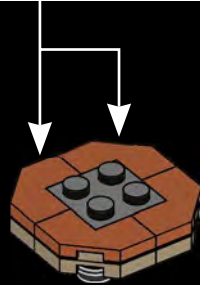
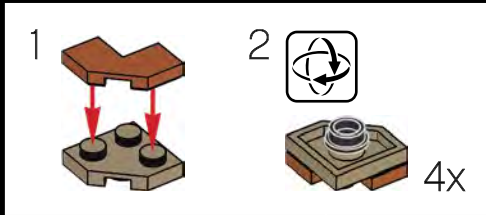

191

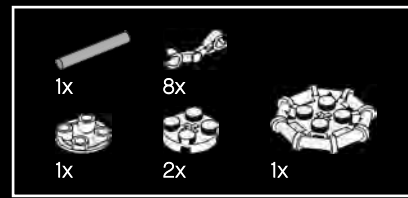

192

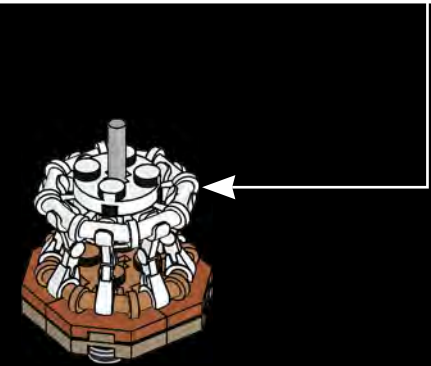
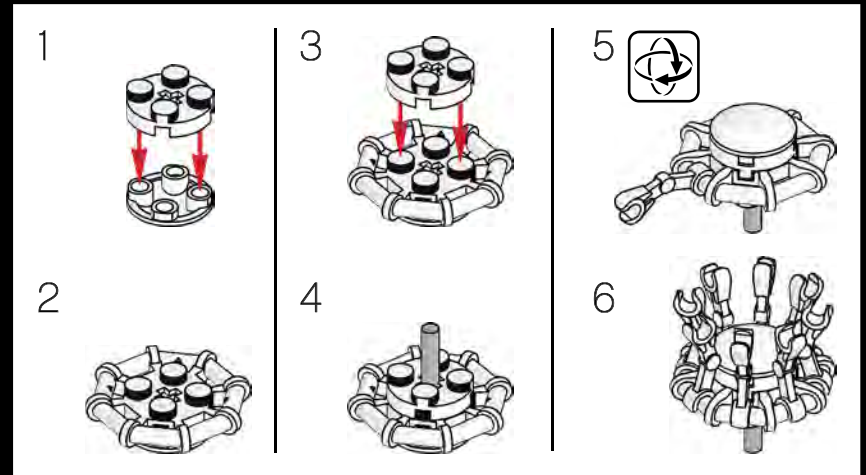



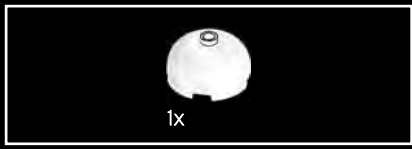

193



194



195



4x

196

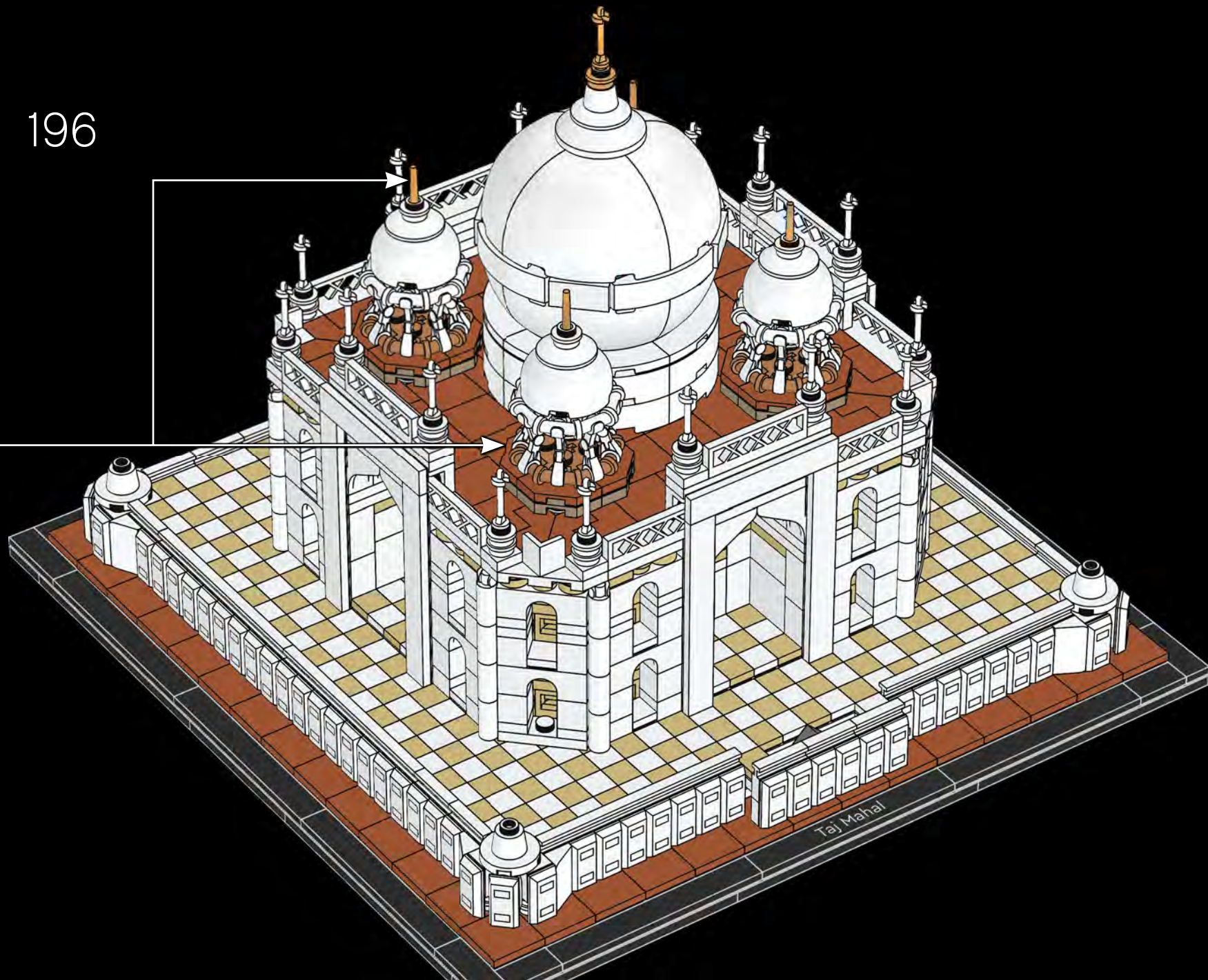

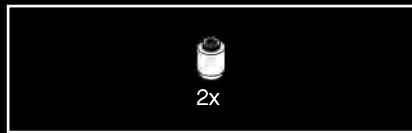
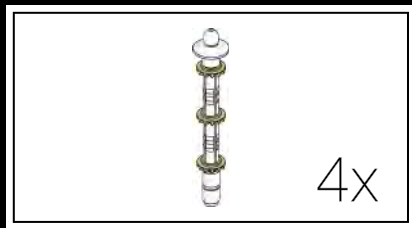

197



198

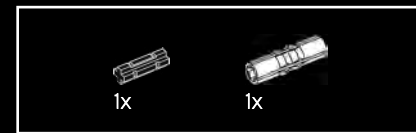

199







200

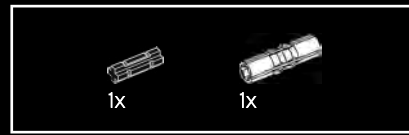

201





202



203



4x

As a safety measure, the four minarets lean slightly outward rather than stand straight. Thus, if any of them fell, they would fall away from the tomb.

Par mesure de sécurité, les quatre minarets sont légèrement inclinés vers l'extérieur plutôt que d'être parfaitement droits. Ainsi, en cas d'écroulement, ils tomberaient dans la direction opposée au tombeau.

Como medida de seguridad, los cuatro minaretes están ligeramente inclinados hacia afuera en lugar de permanecer rectos. De este modo, si alguno se derrumbara, no lo haría sobre las tumbas.



204





Celebrate the world of architecture and collect all the models  
Célébrez le monde de l'architecture et collectionnez tous les modèles  
Celebra el mundo de la arquitectura y colecciona todos los modelos

21045  
Trafalgar Square



21042  
Statue of Liberty  
La statue de la Liberté  
Estatua de la Libertad



21046  
Empire State Building  
L'Empire State Building



21054  
The White House  
La Maison-Blanche  
La Casa Blanca



21028  
New York City  
New York  
Nueva York



21043  
San Francisco

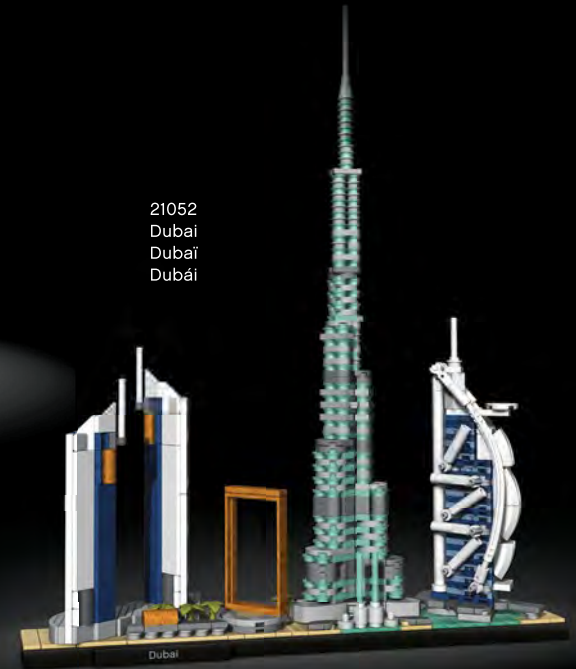

21052  
Dubai  
Dubāī  
Dubái



21044  
Paris

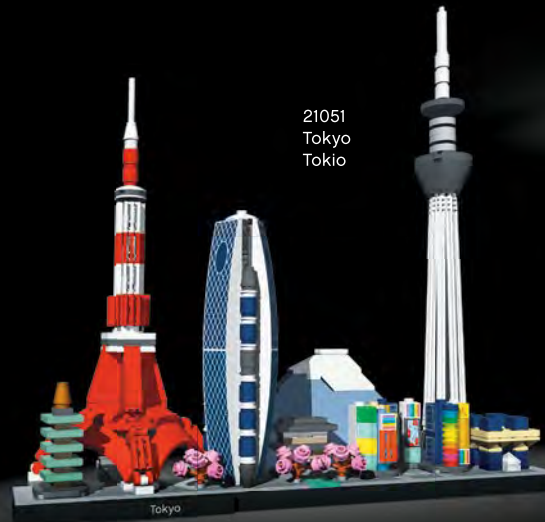

21051  
Tokyo  
Tokio



21034  
London  
Londres

The Transamerica Pyramid Building is a registered service mark of Transamerica Corporation and is being used with permission.

© Pyramide du Louvre, architecte I. M. Pei, musée du Louvre.

© TOKYO-SKYTREE

東京スカイツリー®/东京晴空塔®/TOKYO SKYTREE

© Jumeirah International LLC











# FEEDBACK AND WIN



## FEEDBACK AND WIN

Your feedback will help shape the future development of this product series.

Please visit:

## FEEDBACK UND GEWINNEN

Dein Feedback trägt zur Weiterentwicklung dieser Produktreihe bei.

Geh auf:

## COMMENTEZ ET GAGNEZ

Vos commentaires nous aideront à concevoir les futurs produits de cette gamme.

Rendez-vous sur :

## COMENTA Y GANA

Tu opinión nos ayudará a dar forma al desarrollo de esta serie de productos en el futuro.

Visita:

## 反馈有奖

您的反馈将有助于我们在今后改进本系列产品。

请访问：

[LEGO.com/productfeedback](https://www.lego.com/productfeedback)

By completing, you will automatically enter a drawing to win a LEGO® set.

Terms & Conditions apply.

Durch Ausfüllen nimmst du automatisch an der Verlosung eines LEGO® Preises teil.

Es gelten die Teilnahmebedingungen.

En envoyant vos commentaires, vous serez automatiquement inscrit(e) à un tirage au sort qui vous permettra de remporter un prix LEGO®.

Offre soumise à conditions.

Al contestar, participarás automáticamente en el sorteo y podrás ganar un set LEGO®.

Sujeto a Términos y Condiciones.

完成我们的反馈调查，即可自动进入抽奖环节，赢取乐高®套装。

适用《条款和条件》。

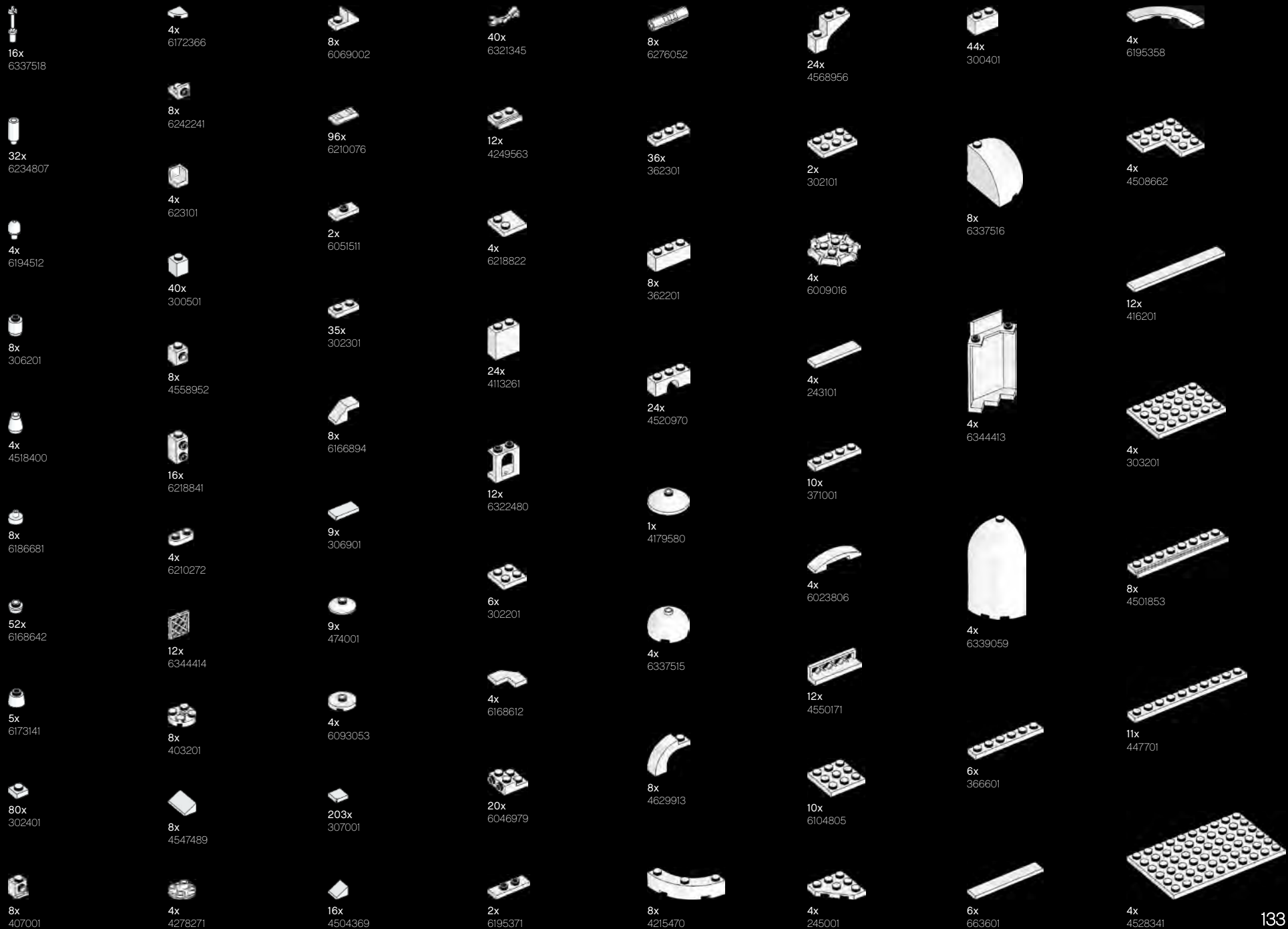



20x  
6284573

16x  
4109995

4x  
4208072

8x  
6186012

16x  
6228921

44x  
4161734

20x  
4113917

4x  
4124067

2x  
4614158

8x  
4550168

36x  
4159553

4x  
6314477

4x  
4181134

61x  
6186423

8x  
6210581

60x  
4118793

4x  
6226565

4x  
4113993

24x  
6253425

4x  
4211385

8x  
6145570

4x  
4124455

2x  
4114324

28x  
6341393

4x  
6079461

191x  
4125253

8x  
4114077

4x  
4125217

8x  
6058089

2x  
4211438

12x  
4565452

12x  
4121921

3x  
6156462

4x  
4640844

1x  
6015349

8x  
6212758

2x  
6115031

3x  
6156462

4x  
4657459

24x  
4211407

8x  
6092587  
134

1x  
6292254

1x  
6190252

2x  
6342086

4x  
6147169

4x  
6177189

2x  
4504378

4x  
4210700

1x  
4226221

7x  
4211063

4x  
4211094

1x  
4210997

2x  
300328

2x  
4125281

4x  
4107758

4x  
4106356

8x  
303428

2x  
4153825

2x  
6212079

4x  
4153827

1x  
6240515

8x  
4504380

1x  
6194417

10x  
302323

33x  
302123

1x  
371023

4x  
4243815

1x  
4199519

16x  
614126

8x  
4109810

4x  
306926

1x  
6308883

4x  
242026

4x  
4558170

4x  
300126

6x  
366626

2x  
379526

11x  
416226

1x  
6338083

4x  
303226

10x  
383226

Customer Service  
Kundenservice  
Service Consommateurs  
Servicio Al Consumidor  
LEGO.com/service or dial

 : 00800 5346 5555  
: 1-800-422-5346



