

M11-8M

Instruction Manual



Content

Package Contents	1
Optional Accessories	1
Overview	2
Function Buttons	2
Control Panel	2
OSD Mode	3
Compound Key	3
LED Indicator	3
Device Connection.....	4
Power Connection to Wall Outlet.....	4
Power Connection to PC/Laptop.....	5
HDMI Connection.....	6
USB Connection	6
Insert a Micro SD Card	7
Operate the Camera with AVerTouch	8
Presentation Mode (Live).....	9
Annotation	9
PIP Function.....	11
PBP Function	12
Playback Mode	14

Switch to Playback Mode	14
OSD Menu Buttons	15
Playback Menu Buttons.....	15
Slide Show	15
Interval	16
Storage.....	16
Delete File	16
Delete All	16
Annotation	17
Use the Camera.....	20
Camera Head Angle.....	20
Camera Body Angle	20
Shooting Area.....	21
Object Position	22
Store the Camera	22
Specification.....	23

Package Contents

The items below are included with this product. If any item is missing, contact the dealer from whom you purchased this product.

M11-8M unit

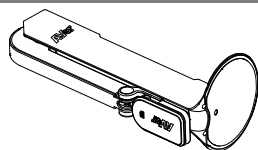

USB Cable

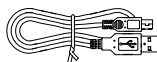

QR Code Card

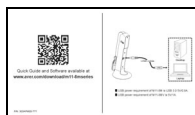

Optional Accessories

Carrying Bag



Anti-glare Sheet

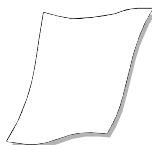



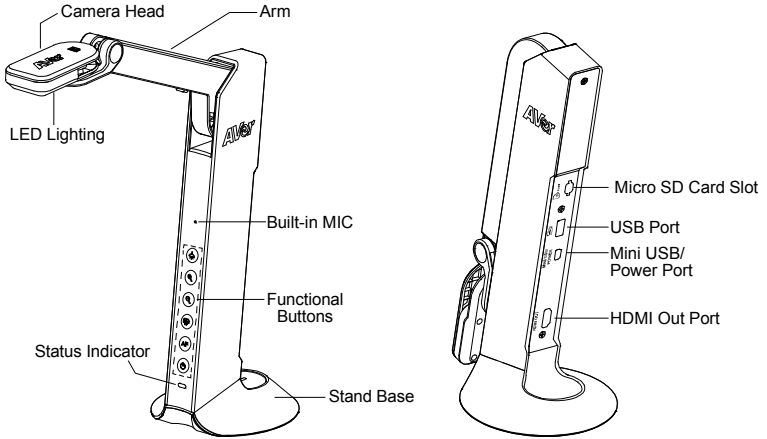



Overview







Function Buttons

Control Panel





Button	Function
	<ul style="list-style-type: none"> ■ Lamp on/off ■ Press and hold 3 seconds to call out OSD menu.
	Zoom in
	Zoom out
	<ul style="list-style-type: none"> ■ Rotate 0/180° ■ Press and hold 3 seconds to freeze the screen. To un-freeze, press and hold 3 seconds again.
	<ul style="list-style-type: none"> ■ Auto focus ■ Press and hold 3 seconds to start recording. <p>To stop recording, press and hold  3 seconds again.</p>
	Power on/off

OSD Mode

Button	Function
	<ul style="list-style-type: none">■ Back to last menu level page■ Exit from OSD menu
	Up (selection item)
	Down (selection item)
	Selection enter

Compound Key

Press keys to operate the compound key function.

Button	Function
 + 	Back to factory default settings
 + 	Capture image

[Note] For **Recording** and **Capture**, please change to **“Power Supply only”** mode.

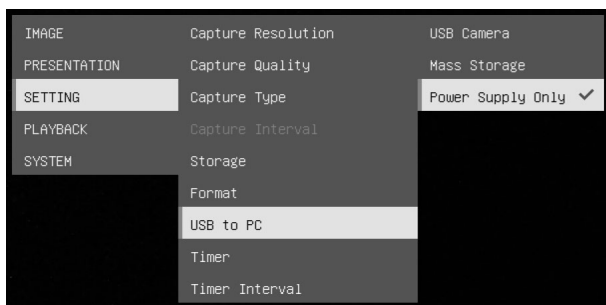

LED Indicator

Power 	Solid green: Power on Solid red: Standby Flashing red: The camera is in start-up process.
---	--

Device Connection

Power Connection to Wall Outlet

1

Plug in power and turn on M11-8M.

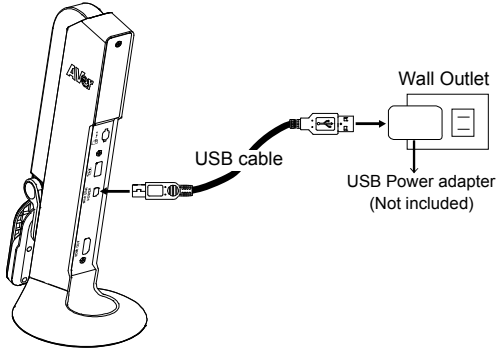

[Note]

- Use the USB cable included in the package to connect to mini USB/Power port of M11-8M with a USB power adapter (not included) to wall outlet.
- User needs to purchase a 5V/1A USB power adapter (not included) to connect the USB cable to wall outlet.
- When the camera is start-up, the power indicator is in flashing red.

Power Connection to PC/Laptop

1

Connect to USB port of PC/laptop for power supply.

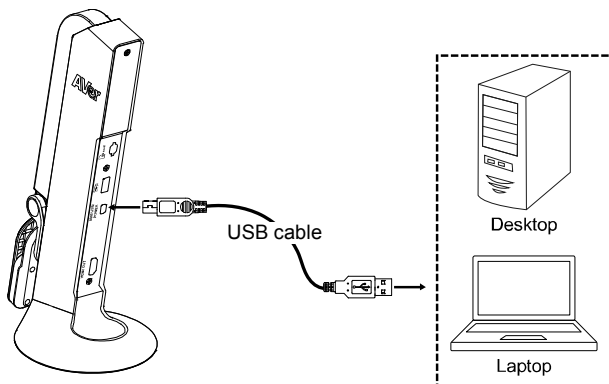

[Note]

- Use the USB cable included in the package to connect to mini USB/ Power port of M11-8M with laptop/PC.
- When the camera is start-up, the power indicator is in flashing red.
- USB power requirement of M11-8M is USB 3.0 5V/0.9A.
- For Storage, Format, Capture, Recording and Playback functions, please change to **"Power Supply Only"** mode

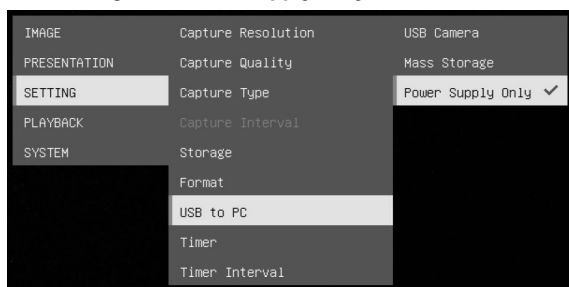

HDMI Connection

1 **Connect M11-8M to HDMI display with HDMI output port.**

The diagram illustrates the connection of the M11-8M device to an HDMI display. On the left is the M11-8M device. A USB cable is connected to the USB port on the device and the USB power adapter. The power adapter is plugged into a wall outlet. An HDMI cable is connected to the HDMI output port on the device and the HDMI input port on the display. The display is shown in a dashed box and can be either an HDMI monitor or an LCD/DLP projector.

Wall Outlet
USB Power adapter
(Not included)

USB cable

HDMI cable
(Not included)

HDMI monitor
LCD/DLP projector

USB Connection

1 **Connect USB flash drive to USB port to save the capture and recording file.**

The diagram shows the M11-8M device with a USB flash drive inserted into its USB port. A callout box with a dashed border contains the instruction: "Press and hold the (AF) button for 3 seconds to start recording".

USB flash drive(FAT32, 32GB)

Press and hold the (AF) button
for 3 seconds to start recording

[Note]The supported USB flash drive maximum is 32G (FAT32).

Insert a Micro SD Card

1

Insert the card to micro SD card slot.

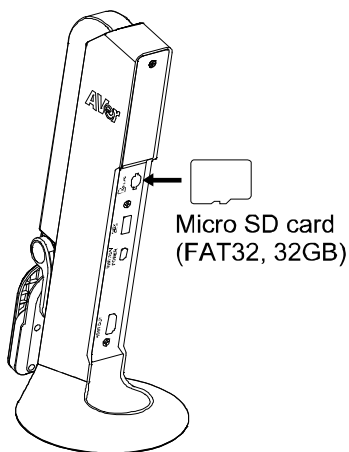

[Note]

- Micro SD card can store capture images and recording files.
- The supported micro SD card capacity maximum is 32G (FAT32).

Operate the Camera with AVerTouch

1

Connect the camera to PC/laptop and Install the AVerTouch application.

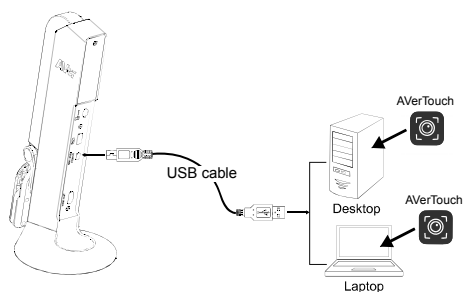

[Note]

- Download AVerTouch application at:
<https://averusa.com/education/support/avertouch>
- Please set the camera to USB mode. Go to **OSD menu > SETTING > USB to PC > USB Camera**.

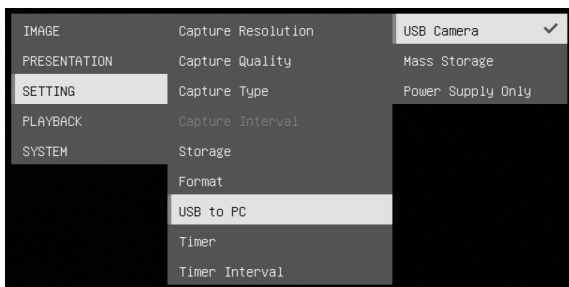

2

Open AVerTouch application, click  to connect the camera.

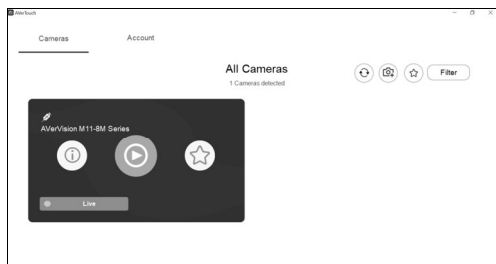

Presentation Mode (Live)

[Note] Before using annotation feature or PIP/PBP function of presentation mode, set the camera to Power Supply Only mode first. Go to **OSD menu > SETTING > USB to PC > Power Supply Only**.

Annotation

In single image live (preview) mode, user can use the annotation feature to overlay straight line or freeform line on the captured image with the USB mouse connected to the USB port of M11-8M.

1. Connect the mouse to USB port of M11-8M.

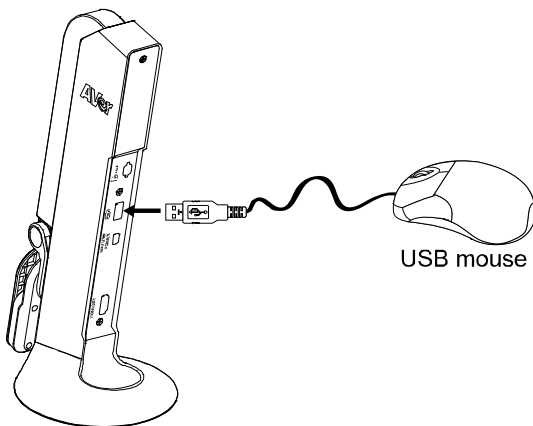

2. Go to **OSD menu > PRESENTATION > Annotation**.

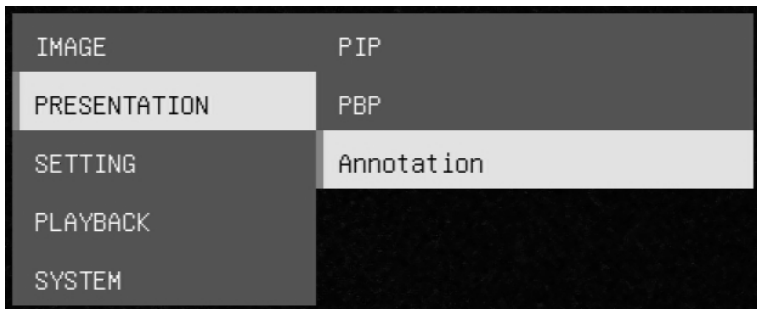



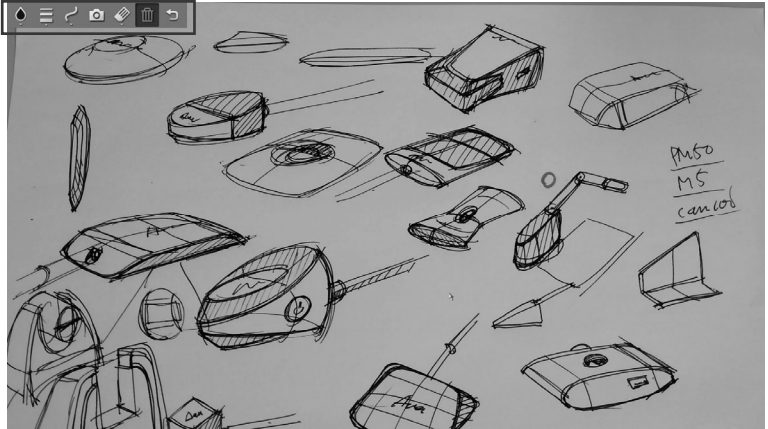







3. In live screen, right-click mouse to call out annotation bar.



Annotation bar description



Button	Function
 Color Palette	Select the line color. 
 Line Thickness	Select the thickness of the line. 
 Line	Select a straight line, freehand or sharp to draw. 
 Capture	Capture the image with the annotation and save it as a new file.
 Eraser	Select to erase any part of the annotation that it comes in contact with or delete all annotation.
 Delete	Clear all annotation on the screen.
 Back	Exit annotation bar.

PIP Function

Select the thumbnail playback screen location and show the thumbnail playback screen at the corner of the screen to recall the captured image from the SD card.





1. In camera mode, press and hold  button for 3 seconds to call out OSD menu.
2. Use  and  buttons to move to **PRESENTATION > PIP**. Press  to confirm the selection.
3. Select the display location of thumbnail playback screen – **Upper Left**, **Upper Right**, **Lower Left**, or **Lower Right**. Press  to confirm the selection.

IMAGE	PIP	Upper Left
PRESENTATION	PBP	Upper Right
SETTING	Annotation	Lower Left
PLAYBACK		Lower Right
SYSTEM		

4. The PIP display screen shows as following.

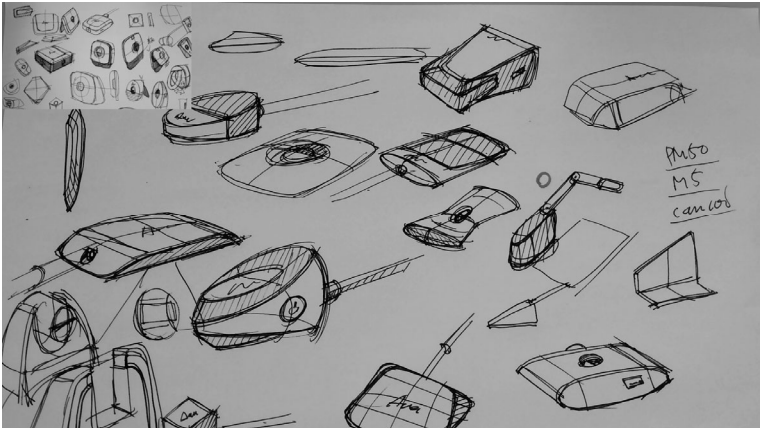

PBP Function

Select the captured image location and show the capture image on the screen to recall the captured image from the SD card.







1. In camera mode, press and hold  button for 3 seconds to call out OSD menu.
2. Use  and  buttons to move to **PRESENTATION > PBP**. Press  to confirm the selection.
3. Select the display location of thumbnail playback screen – **Upper Left, Upper Right, Lower Left, or Lower Right**. Press  to confirm the selection.

IMAGE	PIP	Up
PRESENTATION	PBP	Down
SETTING	Annotation	Left
PLAYBACK		Right
SYSTEM		

4. Use  and  buttons to select the captured image from the list



5. The PBP display screen shows as following (PBP is down location). Use

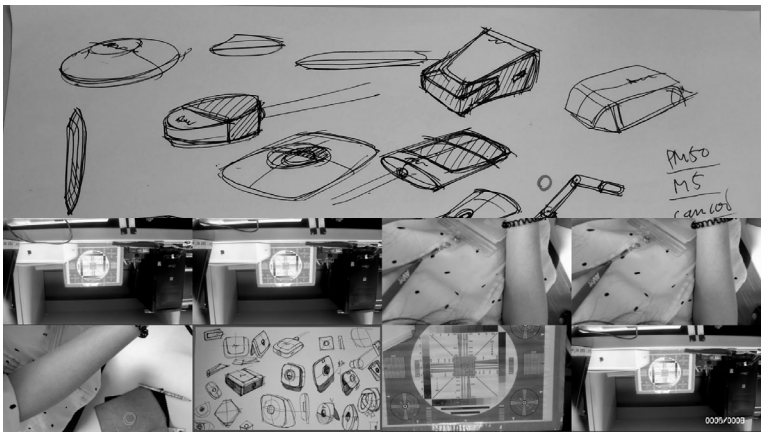

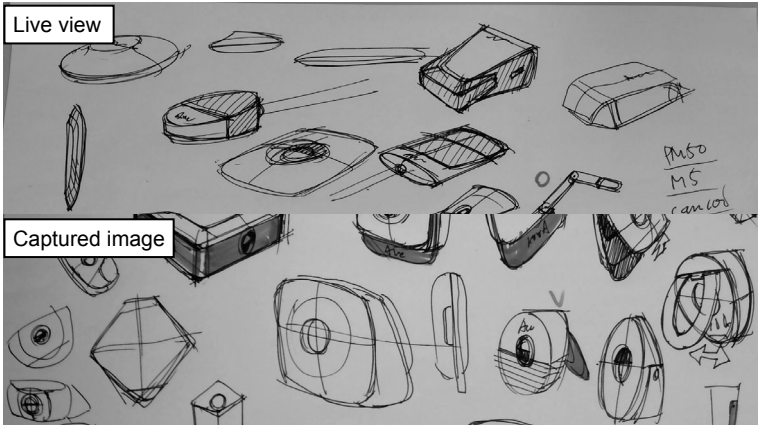

buttons to move the captured image up and down to view.











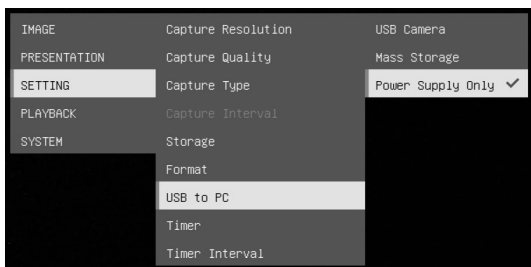



Playback Mode

View the capture images and recording files.

Switch to Playback Mode





1. In camera mode, press and hold  button for 3 seconds to call out OSD menu.
2. Use  and  buttons to move to **SETTING > USB to PC > Power Supply Only**.

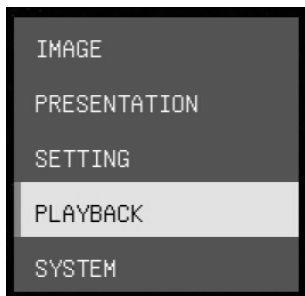













3. Use ,  and  buttons to move to **PLAYBACK** selection.
4. Then, press  to confirm the selection and switch to playback mode.
5. In Playback mode, use  +  and  +  buttons to select image or video to view manually. To play a video, press  button to start playback. To pause playback, press  button again. Press  to stop playback.



OSD Menu Buttons

Button	Function
	Back to last menu level page
	Up (selection item)
	Down (selection item)
	Selection enter

Playback Menu Buttons

Button	Function
 + 	<ul style="list-style-type: none"> Image / video selection
 + 	<ul style="list-style-type: none">  + : Fast forward while playback video  + : Fast rewind while playback video
	Zoom in image
	Zoom out image
	<ul style="list-style-type: none"> Play video Press and hold to pause while video is playback
	Stop play video

Slide Show

To automatically play all capture images and recorded videos; but videos only display files and will not play video contents.



Interval

Set the interval before displaying the next picture. The length can be set up to 120 sec.

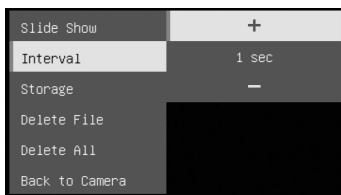

Storage

Select the source of the images and videos.

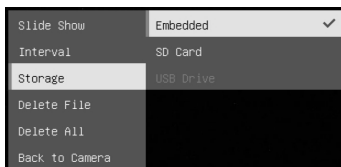

Delete File

Permanently delete the image or video in selected. A Warning Message will appear. Select **Yes** to continue and **No** to cancel the deletion.

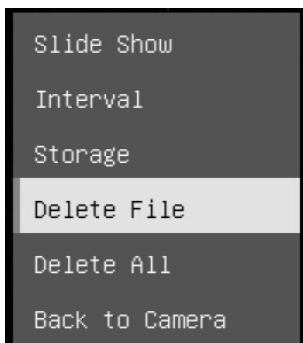
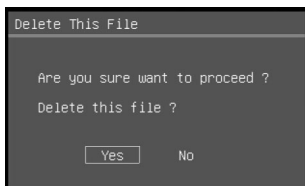

Delete All

Permanently delete all the data in selected memory source. A Warning Message will appear. Select **Yes** to continue and **No** to cancel the deletion.

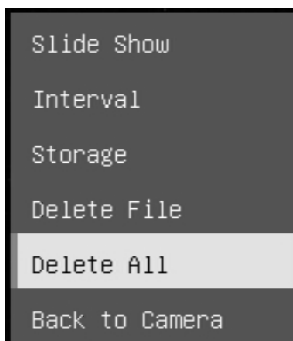
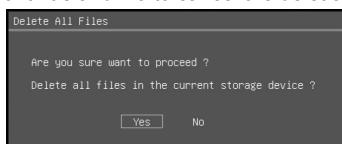



Annotation

In single image playback mode, user can use the annotation feature to overlay straight line or freeform line on the captured image with the USB mouse connected to the USB port of M11-8M.

[Note] Annotation function is not supported with video file.

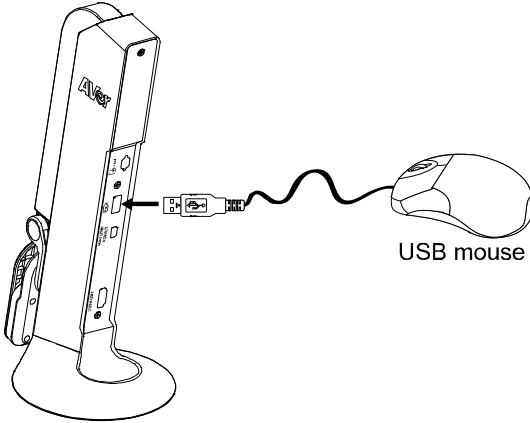
1. Connect the mouse to USB port of M11-8M.





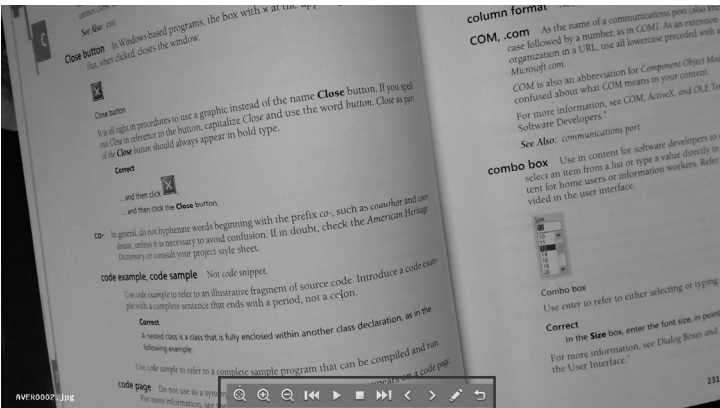











2. Press  to call out OSD menu.
3. Select **"Playback"**.
4. Select the image and playback tool bar is displayed. Or right-click mouse to call out playback tool bar.











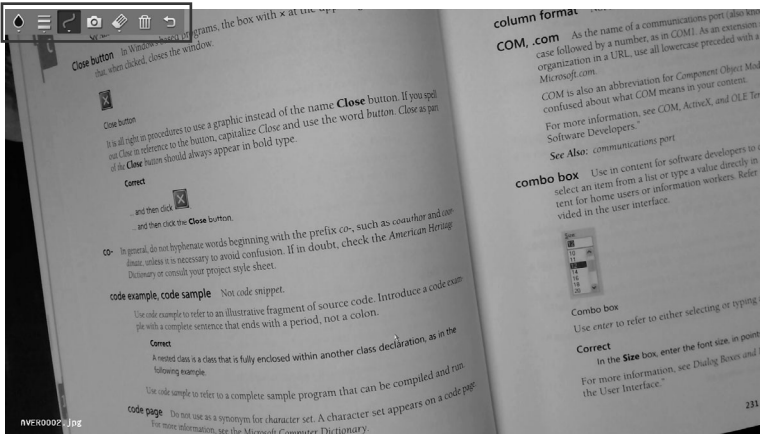

Playback tool bar description



Button	Function
	Move the image to left, right, up, and down. Select  to expand the direction buttons. 
	Zoom in image
	Zoom out image
	Fast Rewind
	Start to play video
	Stop playing video
	Fast forward
	Go to next or back to last image or file
	Switch to annotation function. 
	Back to image or file list

5. To switch to annotation mode, select  on playback tool bar.



Button	Function
 Color Palette	Select the line color. 
 Line Thickness	Select the thickness of the line. 
 Line	Select a straight line, freehand or sharp to draw. 
 Capture	Capture the image with the annotation and save it as a new file.
 Eraser	Select to erase any part of the annotation that it comes in contact with or delete all annotation.
 Delete	Clear all annotation on the screen.
 Back	Back to playback tool bar.

Use the Camera

Camera Head Angle

Move the camera head as figure shown.

[CAUTION] To avoid damage the camera head, hold the edge of the camera head to rotation the camera head.

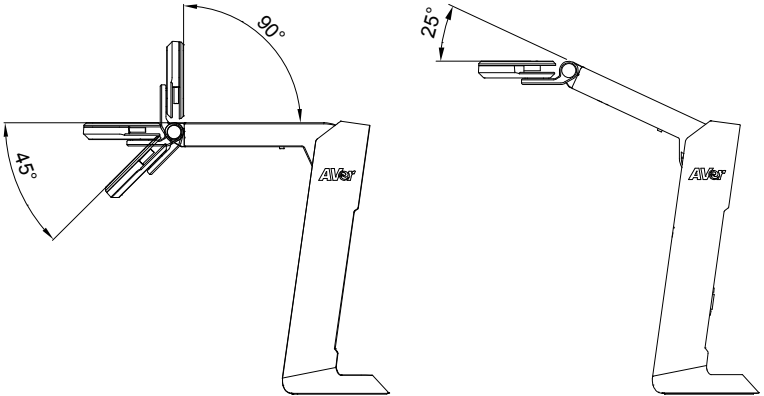
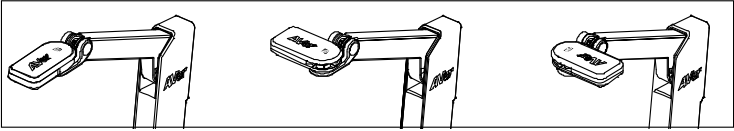

Camera Body Angle

[CAUTION] To avoid damage the camera unit, **DO NOT** pull the arm angle over 107°.

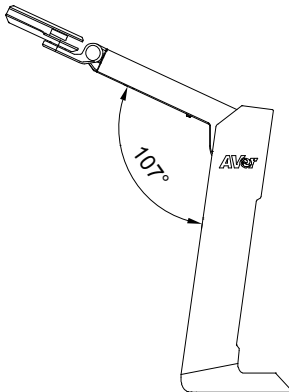

Shooting Area

When camera position is 342.4mm high, the shooting area will be A3 size.

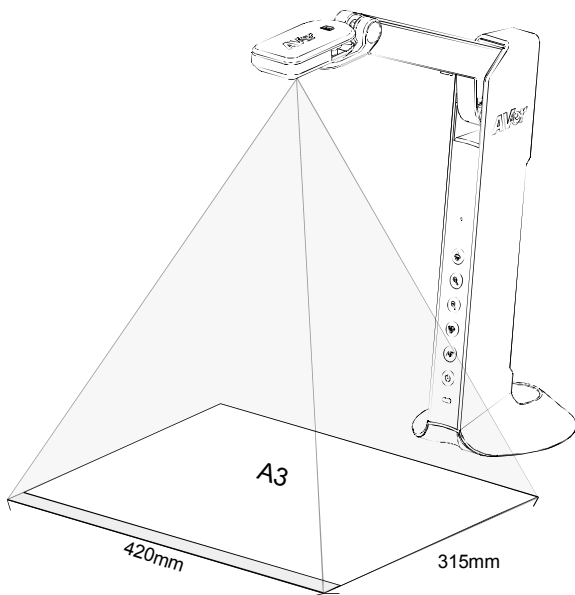
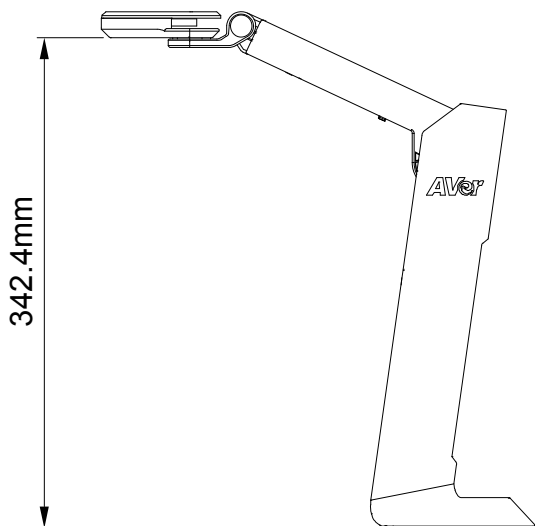

Object Position

The icon on top of camera head can help user to place objects in a positive direction.

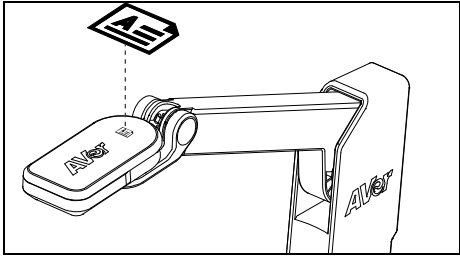

Store the Camera

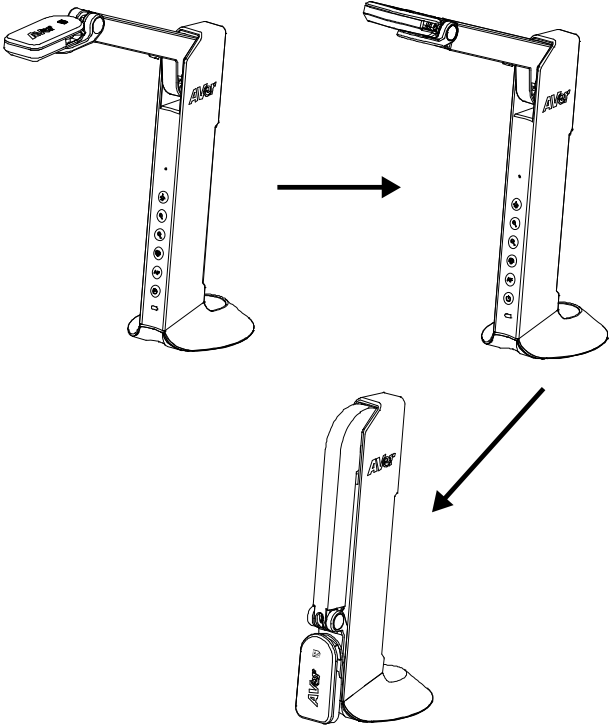

Specification

Sensor	1/3.06" CMOS sensor
Pixel Count	8MP
Frame Rate	Max.60fps (display)
Image mode	Normal / Motion /High Quality
Effect	Color / B&W / Negative
Focusing	Auto / Manual
Shooting Area	A3, 420mm (H) * 315mm (V)
Zooming	20x digital zoom
Power Source	Mini-USB in, 5V/0.9A
Consumption	4 Watts (lamp on) 3.5 Watts (lamp off)
USB Bus Power	Yes, via mini-USB port
Lamp Type	LED light
USB	USB2.0 Type-A x1 (< 5V/0.1A, USB flash drive FAT32, 32GB) USB Type mini-B x 1(Power)
USB Output	3168 x 2376, 1920 x 1080, 1280 x 720, 1024 x 768, 800 x 600, 640 x 480
HDMI Output	1920 x 1080, 1280 x 720, 720 x 480
Image Capture	120 pictures (2 megapixel)
Built-in MIC	Yes
Micro SD card slot	FAT 32,32GB
Operating	360.4mm (H) * 116.7mm (W) * 303.4mm (D)
Folded	296.1mm (H) * 116.7mm (W) *143.1mm (D)
Net Weight	0.83 Kg
Gross Weight	1.301 Kg
Software support	AVerTouch

WARNING

- To reduce the risk of fire or electric shock, do not expose this appliance to rain or moisture. Warranty will be void if any unauthorized modifications are done to the product.
- Do not drop the camera or subject it to physical shock.
- Use the correct power supply voltage to avoid the damaging camera.
- Do not place the camera where the cord can be stepped on as this may result in fraying or damage to the lead or the plug.
- Hold the bottom of the camera with both hands to move the camera. Do not grab the lens or arm to move the camera.

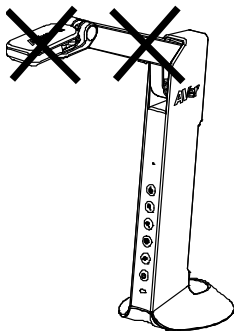

- Do not pull the camera arm and camera part in the opposite direction.

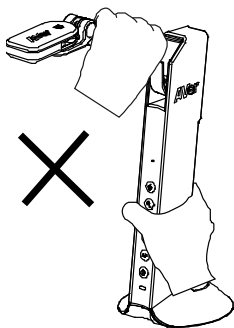

COPYRIGHT

©2020 AVer Information Inc. All rights reserved.

FEDERAL COMMUNICATIONS COMMISSION

NOTE: This equipment has been tested and found to comply with the limits for a Class A digital device, pursuant to part 15 of the FCC Rules. These limits are designed to provide reasonable protection against harmful interference when the equipment is operated in a commercial environment. This equipment generates, uses, and can radiate radiofrequency energy and, if not installed and used in accordance with the instruction manual, may cause harmful interference to radio communications. Operation of this equipment in a residential area is likely to cause harmful interference in which case the user will be required to correct the interference at his own expense.

FCC Caution: Any changes or modifications not expressly approved by the party responsible for compliance could void the user's authority to operate this equipment.

This device complies with part 15 of the FCC Rules.

Operation is subject to the following two conditions:

- (1) This device may not cause harmful interference, and
- (2) this device must accept any interference received, including interference that may cause undesired operation.

Warning:

This is a class A product. In a domestic environment this product may cause radio interference in which case the user may be required to take adequate measures.



THE MARK OF CROSSED-OUT WHEELED BIN INDICATES THAT THIS PRODUCT MUST NOT BE DISPOSED OF WITH YOUR OTHER HOUSEHOLD WASTE. INSTEAD, YOU NEED TO DISPOSE OF THE WASTE EQUIPMENT BY HANDING IT OVER TO A DESIGNATED COLLECTION POINT FOR THE RECYCLING OF WASTE ELECTRICAL AND ELECTRONIC EQUIPMENT. FOR MORE INFORMATION ABOUT WHERE TO DROP OFF YOUR WASTE EQUIPMENT FOR RECYCLING, PLEASE CONTACT YOUR HOUSEHOLD WASTE DISPOSAL SERVICE OR THE SHOP WHERE YOU PURCHASED THE PRODUCT.

DISCLAIMER

No warranty or representation, either expressed or implied, is made with respect to the contents of this documentation, its quality, performance, merchantability, or fitness for a particular purpose. Information presented in this documentation has been carefully checked for reliability; however, no responsibility is assumed for inaccuracies. The information contained in this documentation is subject to change without notice.

In no event will AVer be liable for direct, indirect, special, incidental, or consequential damages arising out of the use or inability to use this product or documentation, even if advised of the possibility of such damages.

More Help

For FAQs, technical support, software and instruction manual download, please visit: <https://www.averusa.com/education/support/>

Contact Information

AVer Information Inc.

www.averusa.com

668 Mission Ct.

Fremont, CA 94539, USA

Toll-free: 1(877)528-7824

Local: 1(408)263-3828

Support.usa@aver.com