

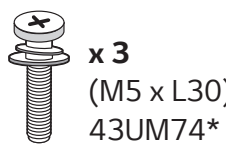

www.lg.com/support

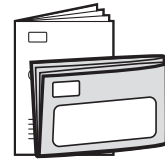
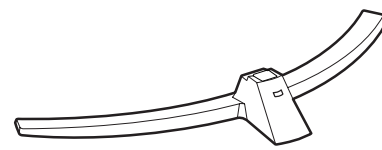
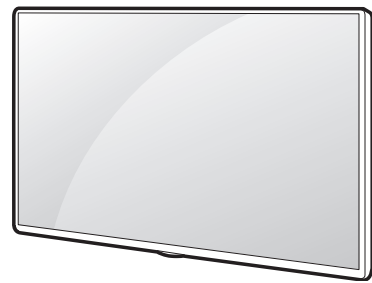

x 3  
(M5 x L30)  
43UM74\*

x 4  
(M5 x L30)  
50/55/65UM74\*

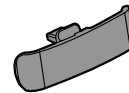
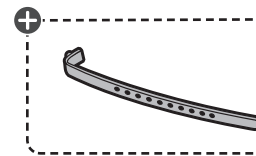
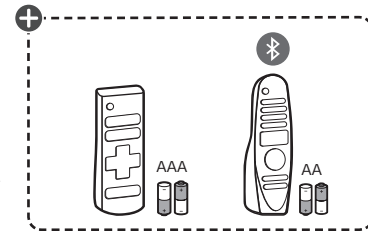

- English** • Read Safety and Regulatory.  
• For the power supply and power consumption, refer to the label attached to the product.
- Deutsch** • Lesen Sie die **Sicherheitsanweisungen und Richtlinien**.  
• Informationen zur Stromversorgung und zum Stromverbrauch sind dem Etikett auf dem Gerät zu entnehmen.
- Français** • Lire le document **Sécurité et mesures réglementaires**.  
• Reportez-vous à l'étiquette apposée sur le téléviseur pour connaître l'alimentation et la consommation électrique.
- Italiano** • Leggere il manuale **Sicurezza e normativa**.  
• Per l'alimentazione e il consumo di energia, consultare l'etichetta applicata sul prodotto.
- Español** • Leer **Seguridad y normativa**.  
• Para obtener información acerca de la fuente de alimentación y el consumo de energía, consulte la etiqueta del producto.
- Português** • Ler informações sobre a **Segurança e Regulamentos**.  
• No que respeita à fonte de alimentação e ao consumo de energia, consulte a etiqueta mostrada no produto.
- Nederlands** • **Veiligheidsinformatie en regelgeving** lezen.  
• Informatie over de stroomvoorziening en het stroomverbruik vindt u op het label op het product.
- Ελληνικά** • Διαβάστε τις **οδηγίες για την ασφάλεια και τους κανονισμούς**.  
• Για πληροφορίες σχετικά με την τροφοδοσία και την κατανάλωση ενέργειας, δείτε την ετικέτα του προϊόντος.
- Slovenščina** • Preberite **varnostne in regulativne vidike**.  
• Podatke o napajanju in porabi energije si oglejte na nalepki izdelka.
- Hrvatski** • Pročitajte **Sigurnost i usklađenost s propisima**.  
• Informacije o napajanju i potrošnji energije potražite na oznaci koja se nalazi na proizvodu.
- Shqip** • Lexoni paragrafin **"Siguria dhe rregullimi"**.  
• Për ushqimin me energji dhe konsumin e energjisë, shih etiketën e ngjitur në produkt.
- Bosanski** • Pročitajte dio **Sigurnost i propisi**.  
• Informacije o napajanju električnom energijom i potrošnji električne energije možete pronaći na naljepnici koja se nalazi na proizvodu.
- Македонски** • Прочитajte за **безбедноста и регулативата**.  
• За напојувањето и потрошувачката на енергија, погледнете ја етикетата која е прикачена на производот.
- Svenska** • Läs **Säkerhet och föreskrifter**.  
• För strömförsörjning och strömförbrukning, se etiketten på produkten.

- Magyar** • **Biztonság és szabályozás** megtekintése.  
• A tápellátásra és az áramfogyasztásra vonatkozó adatok a készülékre ragasztott címkén találhatóak.
- Polski** • Prosimy o przeczytanie **Zasad bezpieczeństwa i uwag dotyczących przepisów**.  
• Dokładne informacje o zasilaniu i zużyciu energii są umieszczone na etykietce znajdującej się na produkcie.
- Česky** • Přečtěte si část **Bezpečnost a zákonné předpisy**.  
• Informace o napájení a příkonu naleznete na štítku připevněném k výrobku.
- Slovenčina** • Prečitajte si **bezpečnostné a regulačné informácie**.  
• Informácie o zdroji napájania a spotrebe elektrickej energie nájdete na štítku pripojenom k zariadeniu.
- Română** • Consultați manualul referitor la **siguranță și reglementare**.  
• Pentru surse de alimentare și consumul de energie, consultați eticheta atașată pe produs.
- Български** • Прочетете **Безопасност и регулаторни стандарти**.  
• Направете справка с етикета на продукта за електрозахранването и консумацията на енергия.
- Eesti** • Lugege **ohutus- ja normatiivteavet**.  
• Toiteallika ja energiatarbe kohta saate teavet tootele kinnitatud märgiselt.
- Lietuvių k.** • Perskaitykite **Saugos ir norminius reikalavimus**.  
• Informacijos apie maitinimą ir energijos sąnaudas rasite etiketėje ant gaminio.
- Latviešu** • Izlasiet sadaļu **Drošība un normatīvi**.  
• Informāciju par elektroenerģijas padēvi un patēriņu skatiet izstrādājumam pievienotajā etiķetē.
- Srpski** • Pročitajte odeljak **Bezbednost i regulatorna pitanja**.  
• Da biste saznali informacije u vezi sa napajanjem i potrošnjom energije, pogledajte oznaku na proizvodu.
- Norsk** • Les **sikkerhet og forskrifter**.  
• Hvis du vil ha informasjon om strømforsyning og strømforbruk, kan du se på etiketten som er festet på produktet.
- Dansk** • Læs **sikkerhed og lovmæssige bestemmelser**.  
• Du kan få oplysninger om strømforsyning og strømforbrug på mærket, der sidder på produktet.
- Suomi** • Lue **Turvallisuus ja säännökset** -osio.  
• Tietoja virtalähteestä ja virrankulutuksesta on laitteeseen kiinnitetyssä tarrossa.

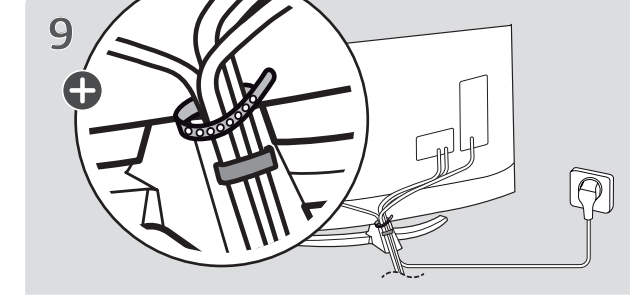
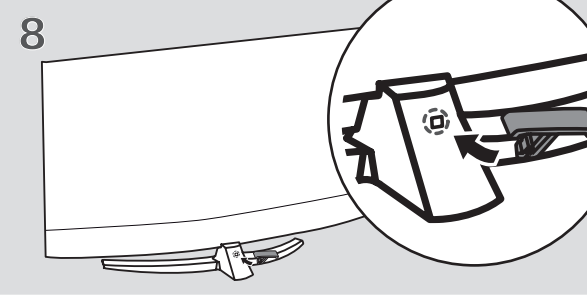
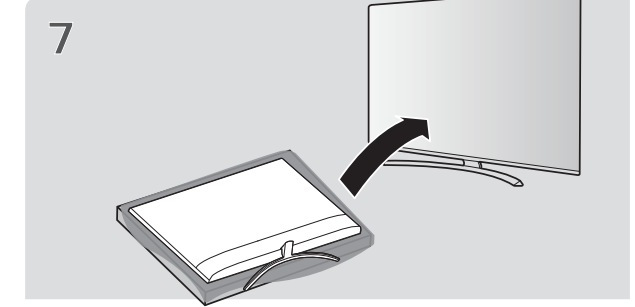
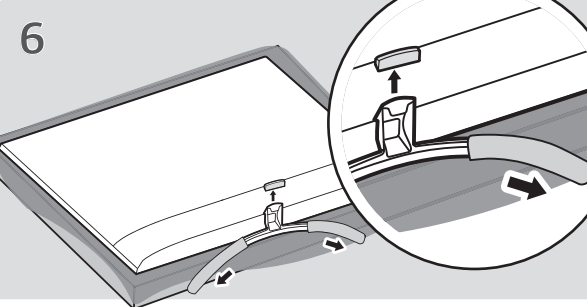
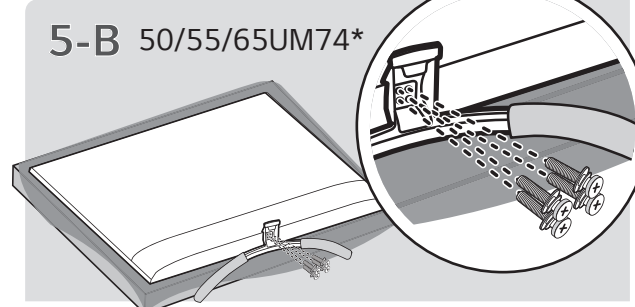
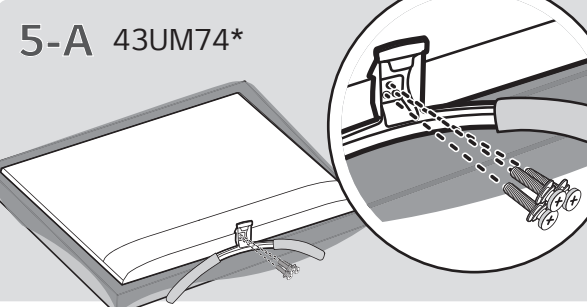
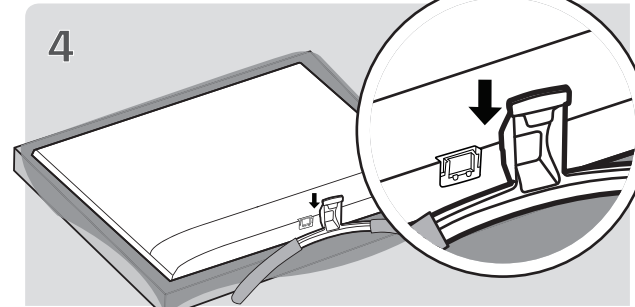
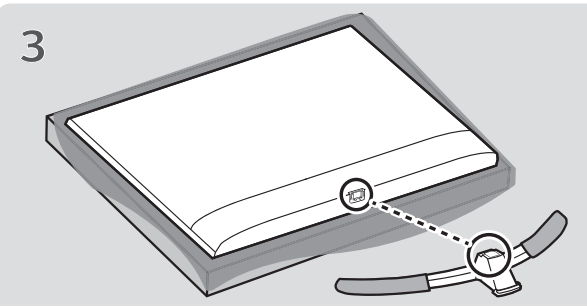
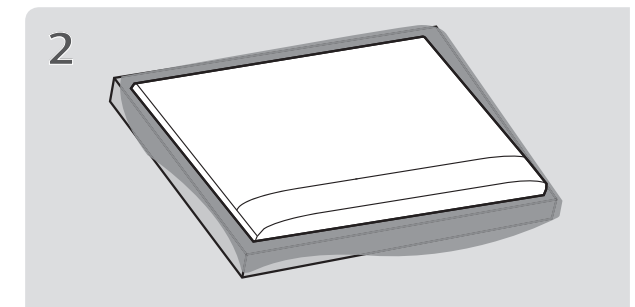
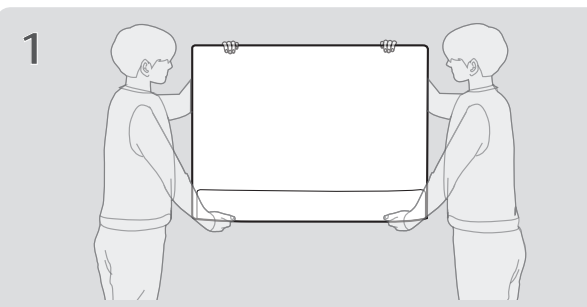

⊕ : Depending on model / Abhängig vom Modell / Selon le modèle / In base al modello / En función del modelo / Dependendo do modelo / Afhankelijk van het model / Ανάλογα με το μοντέλο / Odvisno od modela / Típusfüggő / Zależnie od modelu / Závísí na modelu / V závislosti od modelu / În funcție de model / В зависимости от модели / Söltub mudelist / Priklauso nuo modelio / Atkarībā no modeļa / U zavisnosti od modela / Ovisno o modelu / Në varësi të modelit / Ovisno o modelu / Во зависност од моделот / Beroende på modell / Avhengigt av modell / Afhængigt af modellen / Mallin mukaan

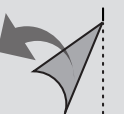

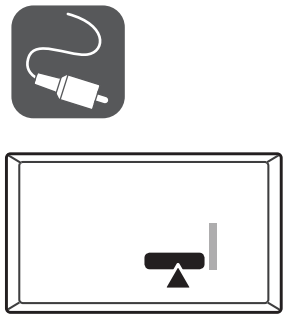

OPTICAL DIGITAL AUDIO OUT

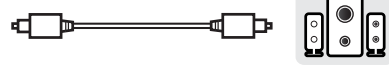

LAN

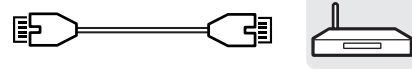

USB IN



HDMI IN



COMPONENT IN

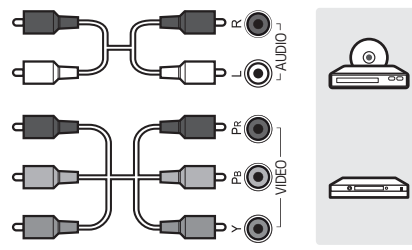

AV IN

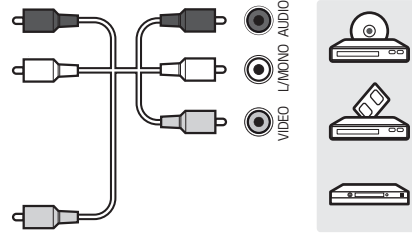

Satellite IN



ANTENNA/CABLE IN

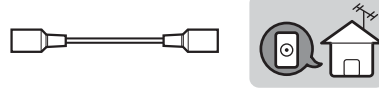

PCMCIA CARD SLOT

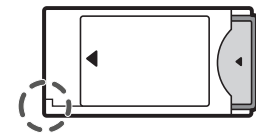

HDMI IN



HDMI IN/ARC



USB IN

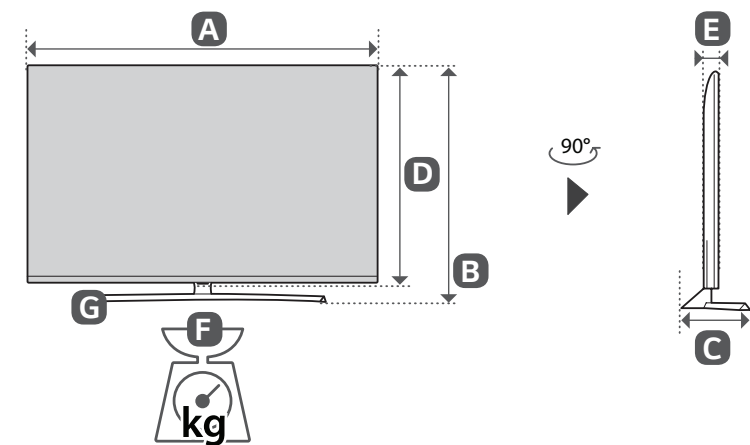
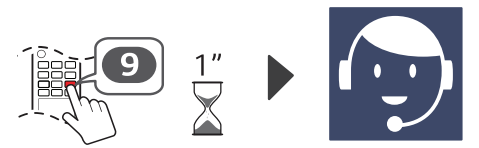
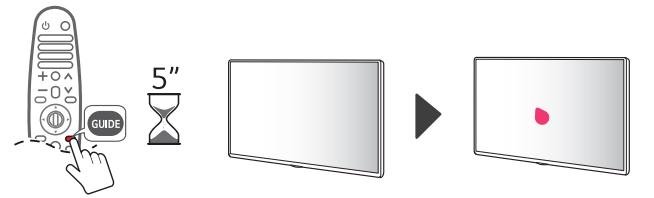
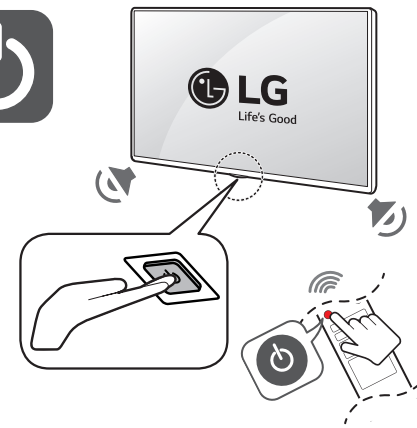
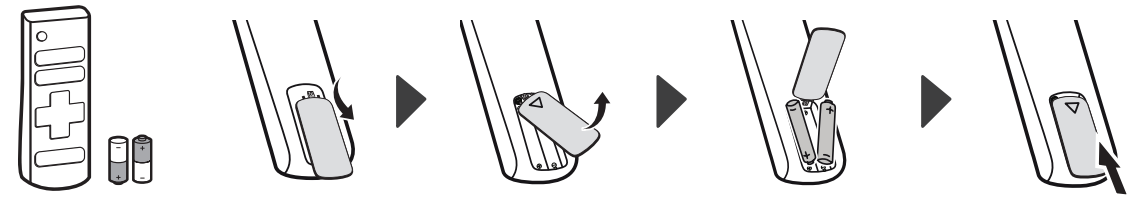
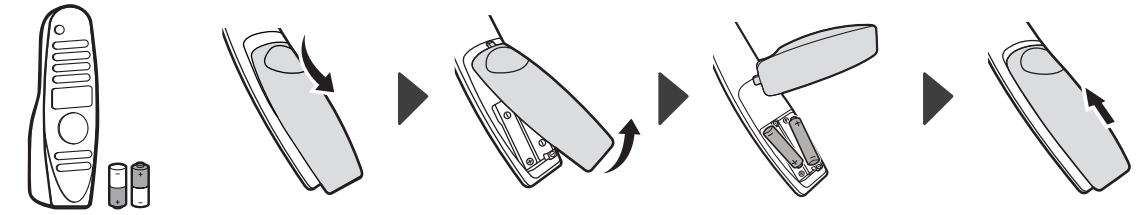

	A	B	C	D	E	F	F-G
	(mm)				(kg)		
43UM7400PLB 43UM74507LA 43UM7450PLA 43UM7490PLC	973	622	221	572	85.0	9.0	8.2
50UM74507LA 50UM7450PLA	1130	728	260	663	86.3	12.5	11.5
55UM7400PLB 55UM74507LA 55UM7450PLA	1244	791	260	726	87.1	15.6	14.6
65UM7400PLB 65UM74507LA 65UM7450PLA	1463	914	340	850	87.8	22.4	21.4
Power requirement				AC 100-240 V ~ 50 / 60 Hz			