

# Bagless Vacuum Cleaner

User's manual

EN



**SENCOR®**

SVC 1030 (Cat & Dog)

Before first use, please read all instructions contained in this user's manual carefully, even if you are already familiar with using similar products. Only use this product in accordance with the instructions described in the user's manual. Keep the user's manual in a safe place where it can be easily retrieved for future use.

Save the original packaging, including the internal packing material, warranty card and proof of purchase receipt, at least for the duration of the warranty. If you need to ship this product, pack it in the original cardboard box to ensure maximum protection during shipping or transport (e.g. when moving or when you need to send this product for repair).

# Bagless Vacuum Cleaner

SVC 1030 (Cat & Dog)

## CONTENTS

IMPORTANT SAFETY NOTICE . . . . .	2
DESCRIPTION OF THE VACUUM CLEANER . . . . .	5
VACUUM CLEANER ASSEMBLY . . . . .	6
VACUUM CLEANER OPERATION . . . . .	6
VACUUM CLEANER ACCESSORIES . . . . .	7
VACUUM CLEANER STORAGE . . . . .	8
CLEANING AND MAINTENANCE . . . . .	8
TROUBLESHOOTING . . . . .	11
TECHNICAL SPECIFICATIONS . . . . .	12
DISPOSAL OF USED ELECTRICAL AND ELECTRONIC EQUIPMENT . . . . .	12
INSTRUCTIONS AND INFORMATION REGARDING THE DISPOSAL OF USED PACKAGING MATERIALS . . . . .	12

# Bagless Vacuum Cleaner

SVC 1030 (Cat & Dog)

EN

## IMPORTANT SAFETY NOTICE

- 1) Carefully unpack the product and take care not to throw away any part of the packaging before you find all the parts of the product.
- 2) This product may not be used by any persons (including children) with mental disabilities, weak strength or by inexperienced persons, unless they have been properly trained or schooled in the safe use of the product, or unless they are properly supervised by a qualified person who is responsible for their safety.
- 3) Children must be supervised to ensure that they do not play with the product.
- 4) Before connecting this product to the socket outlet, make sure the voltage stated on the label of the product corresponds to the voltage in your wall socket.
- 5) Never use accessories, which have not been supplied with this product or which are not designed for this product.
- 6) Do not place the power cord near hot places or sharp objects. Do not place heavy objects on the power cord. Position the power cord so that it will not be stepped on or tripped over. Make sure the power cord is not touching a hot surface.
- 7) If the power cord of the product is damaged have it repaired by an authorised service technician to prevent causing a dangerous situation. It is forbidden to use the product if it has a damaged power cord or plug.
- 8) Do not disconnect the power cord from the wall outlet by pulling the cord.
- 9) In no case should you attempt to repair the unit yourself, do not make any amendments to it - danger of electric shock! Entrust all repairs and adjustments to a specialised company/service. Failure to do so will expose you to a danger of voiding the warranty policy.
- 10) Never use the product if you have wet hands or feet.
- 11) Only store and use the product away from flammable or volatile materials and solutions.
- 12) This product is designed for household use. Do not use it in industrial surroundings or outdoors!
- 13) Do not use the product for purposes other than those intended.
- 14) Do not spray the product with water or any other liquid. Do not pour water or any other liquids into the product. Do not submerge the product in water or in any other liquid.
- 15) Make sure the product does not come in contact with water. Never use the product near a bathtub, wash basin or any other containers filled with water.
- 16) If you are not using the product, disconnect the power cord from the socket.
- 17) If you will not be using the product, turn it off and disconnect the power cord from the wall outlet. Prior to cleaning, proceed in the same manner.
- 18) Never leave the product switched on without supervision.
- 19) In order to avoid deformation or a fire in the plastic components of the vacuum cleaner, do not expose the vacuum cleaner to direct sunlight, do not place it close to heaters, open fires or other sources of heat and do not leave the vacuum cleaner operating for too long if the air inflow is blocked.
- 20) Do not use the product in an excessively dusty environment.
- 21) Use extra care if the product is used near children. Always keep the product out of the reach of children.
- 22) If the product is being used, do not block the air inflow and outflow openings. Blocked air vents can cause overheating and motor damage.
- 23) Vacuuming the below mentioned objects can damage your product or cause injuries to the operating person:
  - wet floor, water or other liquids
  - any type of sharp objects such as broken glass or ceramics, needles, pins, etc.
  - burning cigarettes, or smouldering pieces, matches or any other flammable or volatile liquids (e.g. gasoline, paint thinners, etc.)
  - flour, cement, plaster (i.e. dust from holes drilled in walls)
- 24) In order to avoid damaging furniture or injuries to persons, hold the cord in your hand as it winds up.
- 25) Do not vacuum larger pieces of paper or plastic bags. They may easily clog the pipe or hose. In case the vacuum cleaner becomes clogged for any reason, turn it off by disconnecting it from the electric socket and clean the pipe or hose.
- 26) In order to avoid damage to the hose, do not step on it or forcefully bend it. Do not use the vacuum cleaner if the hose is bent or damaged in any other way.
- 27) Do not move over the power cord with the vacuum cleaner.

# Bagless Vacuum Cleaner

SVC 1030 (Cat & Dog)

- 28) Never use the vacuum cleaner without the protective motor filter, the outflow filter, inserted dust container or the HEPA filter.
- 29) Do not place the vacuuming hose, inlet nozzle or vacuuming accessories near to your eyes or ears.
- 30) Vacuuming of some types of floors or floor surfaces can create a static electricity charge, which is not dangerous for the user.

The manufacturer is not responsible for damages caused by incorrect use of this product or its accessories. Such damages include food spoilage, injuries, burns, scalding, fire, etc.

# Bagless Vacuum Cleaner

SVC 1030 (Cat & Dog)

EN

## DESCRIPTION

### A

- ① START/STOP button
- ② Dust container button
- ③ Dust container handle
- ④ Vacuum hose connection socket
- ⑤ Vacuum cleaner handle
- ⑥ Motor power output control
- ⑦ Outflow micro-filter cover
- ⑧ Cord winding button
- ⑨ Rubber wheel
- ⑩ Dust container
- ⑪ Handle
- ⑫ Sliding air suction knob
- ⑬ Telescopic tube
- ⑭ Telescopic tube position lock
- ⑮ Floor inlet nozzle
- ⑯ Flap position for vacuuming hard (smooth) floors
- ⑰ Flap position for vacuuming carpets
- ⑱ Hose
- ⑲ Accessory holder
- ⑳ Stopper for the vertical parking position
- ㉑ Stopper for the horizontal parking position
- ㉒ Clip
- ㉓ Hose end

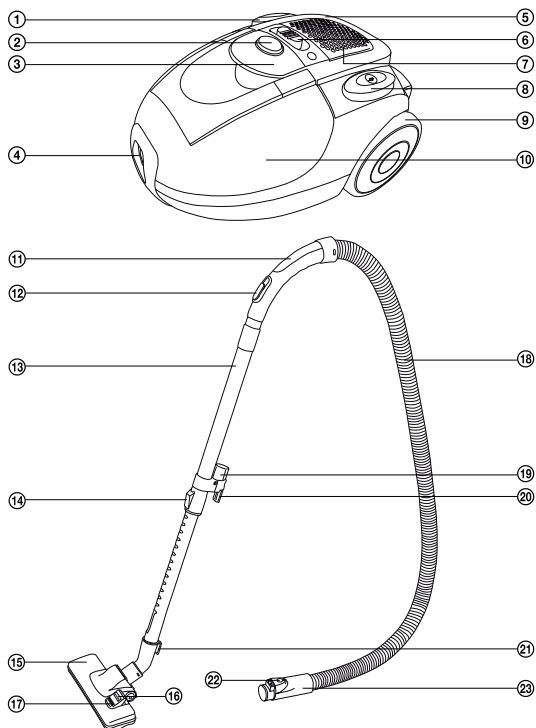

### B

- ① Full dust container indicator
- ② Horizontal parking position
- ③ Power cord

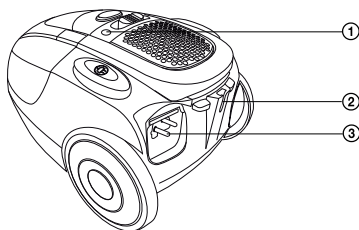

# Bagless Vacuum Cleaner

SVC 1030 (Cat & Dog)

C

- ① Handle
- ② Vertical parking position
- ③ Front wheel mechanism

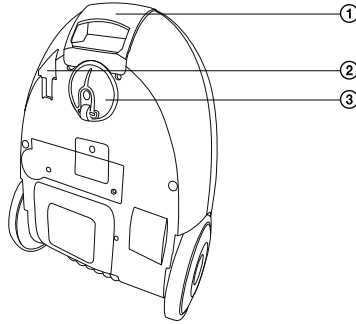

## ASSEMBLY

### Inserting the hose into the air suction socket on the vacuum cleaner:

Press the safety button on the hose end and insert the hose end into the air suction socket on the vacuum cleaner until you hear "click". The hose is now secured in the correct position.

### Attach the holder to the telescopic tube:

Make sure to place the holder with the hose on the wider part of the telescopic tube.

### Attach the floor inlet nozzle to the telescopic tube:

Make sure the floor nozzle is attached the narrower part of the telescopic tube.

### Adjust the length of the telescopic tube:

Adjust the length of the telescopic tube as follows: Move and hold the button on the tube forward as shown the by arrows and adjust the length of the tube as required. Release the button and move the tube slightly forward until you hear a "click". The telescopic tube is now securely fixed in position.

## USING YOUR VACUUM CLEANER

### Connecting your vacuum cleaner to the electrical power grid

Pull the plug attached to the power cord out from the vacuum cleaner until the desired length of the cord is out of the product. Insert the plug into a power socket.



#### Caution:

Yellow marking on the power cord warns that the power cord is close to its end. Do not pull the cord further than the red marking.

Adjusting the floor inlet nozzle according to the floor surface.

You may set the inlet nozzle according to the floor surface by adjusting the inlet flap:

- If you want to vacuum carpets, close the bristles of the inlet inside the inlet nozzle, by turning the flap accordingly.
- If you want to vacuum hard and smooth surfaces, move the bristles out of the nozzle, by turning the flap accordingly.

# Bagless Vacuum Cleaner

SVC 1030 (Cat & Dog)

EN

## Turning your vacuum cleaner on and off

To switch your machine on or off, press the START / STOP button on the vacuum cleaner body.

## Adjusting the suction strength

The suction strength may be adjusted by moving the rider on the vacuum cleaner body ( small range) or by the moveable rider on the hose handler.



### Tips

- Use the maximum suction strength when vacuuming carpets or floors with a hard surface. Use the reduced strength when vacuuming upholstery, window curtains, etc.
- If the hose holder becomes blocked when vacuuming, disconnect it from the telescopic tube and also disconnect the hose from the vacuum cleaner body. Then place the holder inside the suction socket on the vacuum cleaner body and vacuum the stuck dirt out.

## Temporary interruption of the vacuuming process

If you want to stop vacuuming for a short time, you may use one of the parking positions:

- for the horizontal parking position use the stopper at the end of the floor nozzle,
- for the vertical parking position use the stopper on the telescopic tube.



### Attention:

Do not move the vacuum cleaner from place to place if the hose is in the parked position! It may break off or the stoppers for the floor nozzle or telescopic tube may break off.

## USING YOUR ACCESSORIES

D

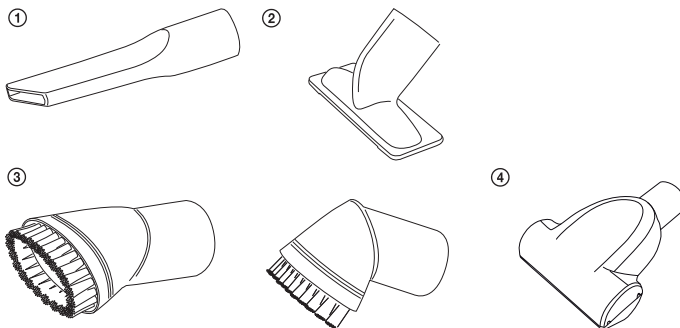

- ① Slot nozzle for vacuuming in hard to reach places (e.g. windows, corners, book shelves, areas between mattresses, upholstery, etc.)
- ② Upholstery nozzle
- ③ Brush nozzle (by turning the brush part it is possible to use it for vacuuming hard to reach places)
- ④ The mini turbo-brush for upholstery can be used for vacuuming animal hair from upholstery. Air vacuum rotates the brushes making the removal and vacuuming of animal hair from couches and sofas very easy. The size of the turbo brushes makes work possible in hard to reach places, where a standard turbo nozzle could not reach.

# Bagless Vacuum Cleaner

SVC 1030 (Cat & Dog)



**Tip:**

If during vacuuming you use an accessory very often, you may attach it to the special holder on the telescopic tube.

## Ending the vacuuming process

When you finish vacuuming, switch the vacuum cleaner off by pressing the START / STOP button and then disconnect the power plug from the socket.

To wind the power cord back to the vacuum cleaner, press and hold the winding button with one hand. Hold the cord with your other hand to protect the vacuum cleaner input area from damage



**Tip:**

If the winding process stops and part of the power cord is still outside, release the winding button and pull the cable out again by about 50 cm and press the winding button again and repeat the winding process.

## Carrying your vacuum cleaner

It is possible to hold and carry the vacuum cleaner using the fold-out handle (pic. A5) or the handle at the front of the vacuum cleaner (pic. C1).



**Caution:**

Never try to carry your vacuum cleaner by holding the dust container handle!

## STORAGE OF VACUUM CLEANER

Before storage you can disassemble your product to the individual parts or you can store it assembled with the telescopic tube stored in one of the parking positions.

## CLEANING AND MAINTENANCE



**Caution:**

Before cleaning disconnect this product from the power source.

### Emptying the dust container

Empty the dust container as soon as the full dust container warning light comes on; otherwise the air flow and the suction strength will be reduced.

**E**

- ① Safety lock of the bottom hatch
- ② Plastic conical filter
- ③ Bottom hatch
- ④ Plastic conical filter

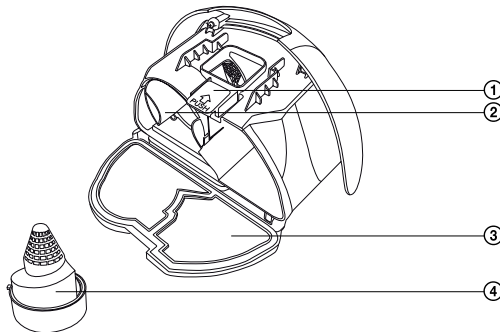



# Bagless Vacuum Cleaner

SVC 1030 (Cat & Dog)

EN

- 1) Press the safety lock and pull the dust container handle up at the same time to remove the dust container from the vacuum cleaner.
- 2) Place the dust container over a waste bin.
- 3) Press the safety clip of the bottom hatch on the dust container and the bottom hatch will open.
- 4) By turning in the anti-clockwise direction remove the plastic conical filter from the dust container, tip out the dust and if necessary wash under running lukewarm water.
- 5) In the same way tip out the dust and dirt from the dust container into ordinary household waste. If the container is heavily soiled you may wash the entire container under lukewarm running water. However, before doing so, it is necessary to remove the H.E.P.A filter and its foam pre-filter from the container!
- 6) Then insert the plastic conical filter back into the dust container and lock in position by turning in the clockwise direction.
- 7) Close the bottom hatch of the dust container. Make sure the safety clip clicks in.
- 8) Place the dust container back into the vacuum cleaner.



### Caution:

Before replacing the dust container and the plastic conical filter back into the vacuum cleaner, make sure that all parts are completely dry.

## Replacing and cleaning the H.E.P.A. filter and the foam pre-filter

F

- ① H.E.P.A. filter
- ② Safety clip for the H.E.P.A. filter

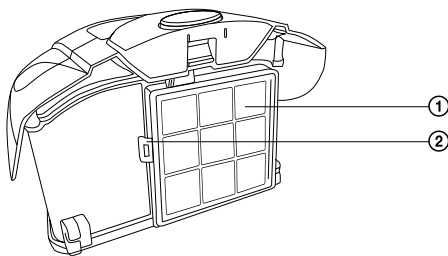

G

- ① Safety clip
- ② Hinge for the H.E.P.A filter frame
- ③ Hinge for the H.E.P.A filter frame
- ④ Foam pre-filter
- ⑤ H.E.P.A. filter

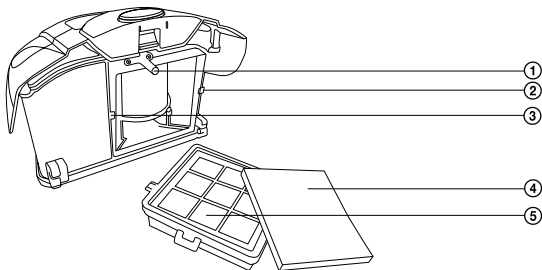

# Bagless Vacuum Cleaner

SVC 1030 (Cat & Dog)

- 1) Press the safety clip and pull the dust container handle up at the same time to remove the dust container from the vacuum cleaner.
- 2) Fold out both safety clips of the H.E.P.A. filter frame, take it off the dust container and from behind it also remove the foam pre-filter.
- 3) Wash both filters under running lukewarm water and if necessary replace with new ones.
- 4) Then first reinsert the foam pre-filter and then the H.E.P.A. filter until you hear both clips click in.
- 5) Place the dust container back into the vacuum cleaner.



## Attention:

Never insert the filters back into the vacuum cleaner if they are wet or damp! Always wait until they are thoroughly dry. The dust container is equipped with a safety clip (see. pic. G ①), which in the absence of the H.E.P.A. filter will not make it possible to insert the dust container into the vacuum cleaner.

## Changing the outflow filter

### H

- ① Outflow micro-filter
- ② Outflow micro-filter cover
- ③ Cover dip
- ④ Cover clip

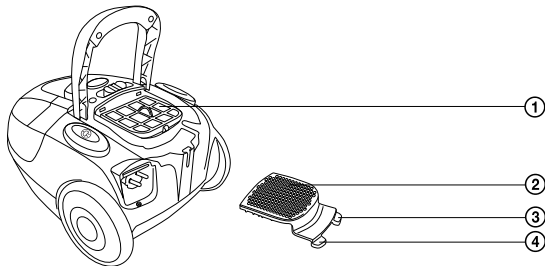

### I

- ① Outflow micro-filter cover
- ② Foam pre-filter
- ③ Outflow micro-filter

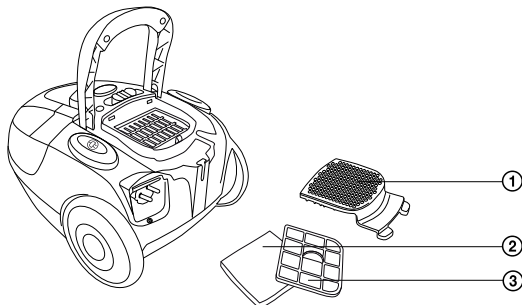

# Bagless Vacuum Cleaner

SVC 1030 (Cat & Dog)

EN

- 1) First remove the grill of the outflow filter by pulling upwards in the place of both safety clips.
- 2) Then remove the outflow filter and the foam pre-filter and replace them with new ones.
- 3) After reinserting both filters attach the cover and click in both clips.



## Caution:

Make sure you put the outflow filter in the vacuum cleaner with the plastic grill facing outwards!

## Cleaning your vacuum cleaner.

To clean the outside parts of the product use a fine cloth dipped in lukewarm water. Do not use aggressive cleaning agents, paint thinners or solvents. Using these solutions could damage the surface of the product.

## TROUBLESHOOTING

Before you decide to contact an authorized service centre, please read these following tips in the troubleshooting chart:

Problem	Possible cause	Recommended action
The engine will not start	<ul style="list-style-type: none"><li>- The power cord is not firmly inserted in the socket</li><li>- The wall power outlet is damaged</li><li>- The vacuum cleaner is not switched on</li></ul>	<ul style="list-style-type: none"><li>- Insert the plug firmly into the power outlet</li><li>- Inspect the power outlet</li><li>- Turn the product on.</li></ul>
The suction output is insufficient	<ul style="list-style-type: none"><li>- The product is clogged</li><li>- The dust filter needs cleaning.</li><li>- The dust container is inserted in the wrong position</li><li>- The filter is clogged</li></ul>	<ul style="list-style-type: none"><li>- Remove the blockage or foreign object</li><li>- Clean the dust filter</li><li>- Close the dust container</li><li>- Clean the filter</li></ul>
The power cord is not wound in completely	The power cord may have slipped down from the winding pulley during winding.	Hold the power cord during the winding. Apply slight tension (by pulling the power cord back) to the power cord during the winding process
The power cord cannot be pulled out	The power cord is wound up incorrectly	Press the winding button and try to rewind the power cord again
The speed control is not working.	The product is out of order	Have the product repaired by a technician. (only by a qualified technician).
The power cord starts to wind in when you do not require.	The winding mechanism is out of order	Have the product repaired by a technician. (only by a qualified technician).
The dust container cannot be closed	The dust filter is inserted incorrectly or in an incorrect position	Reinstall and secure the filter in position and try again

# Bagless Vacuum Cleaner

SVC 1030 (Cat & Dog)

## TECHNICAL SPECIFICATIONS

Nominal voltage .....	220 – 240 V AC
Nominal frequency .....	50 Hz
Rated power input .....	700 W
Safety class (with regard to electric shock protection) .....	II
Noise level .....	76 dB(A)
Length of the power cord .....	6 m
Operating range .....	9 m
Dust container capacity .....	2.3 l
Dimensions (length x width x height) .....	397 x 303 x 228 mm
Weight .....	4.9 kg

The declared noise emission level of the appliance is 76 dB(A), which represents a level A of acoustic power with respect to a reference acoustic power of 1 pW.

Amendments to text and technical parameters are reserved.

# Bagless Vacuum Cleaner

SVC 1030 (Cat & Dog)

EN

## PRODUCT INFORMATION SHEET

Name/trademark	SENCOR
Model identification number	SVC 1030
Energy efficiency class*	A
Annual power consumption (in kWh)**	23.5
Carpet cleaning efficiency class	D
Hard floor cleaning efficiency class	B
Vacuum cleaner dust emission class	C
Level of acoustic power (dB(A))	76
Rated power input (W)	700 W

\* Class A (highest efficiency class, low power consumption) to Class G (lowest efficiency class, high power consumption)

\*\* Approximate annual power consumption (in kWh per year) based on 50 cleaning cycles. Actual power consumption will depend on how the appliance is used.

The values are determined pursuant to (EU) No. 665/2013.

# Bagless Vacuum Cleaner

SVC 1030 (Cat & Dog)

## INSTRUCTIONS AND INFORMATION REGARDING THE DISPOSAL OF USED PACKAGING MATERIALS

Dispose of packaging material at a public waste disposal site.

## DISPOSAL OF USED ELECTRICAL AND ELECTRONIC APPLIANCES



The meaning of the symbol on the product, its accessory or packaging indicates that this product shall not be treated as household waste. Please, dispose of this product at your applicable collection point for the recycling of electrical & electronic equipment waste. Alternatively in some states of the European Union or other European states you may return your products to your local retailer when buying an equivalent new product. The correct disposal of this product will help save valuable natural resources and help in preventing the potential negative impact on the environment and human health, which could be caused as a result of improper liquidation of waste. Please ask your local authorities or the nearest waste collection centre for further details. The improper disposal of this type of waste may fall subject to national regulations for fines.

### For business entities in the European Union

If you wish to dispose of an electrical or electronic device, request the necessary information from your seller or supplier.

### Disposal in other countries outside the European Union

If you wish to dispose of this product, request the necessary information about the correct disposal method from local government departments or from your seller.



This product meets all the basic EU regulation requirements that relate to it.

Changes to the text, design and technical specifications may occur without prior notice and we reserve the right to make these changes.