

HD2178



User manual

PHILIPS



© 2014 Koninklijke Philips N.V.
HD2178_CN_UM_v1.0_140228



English

1 Your electric pressure cooker

Congratulations on your purchase, and welcome to Philips!

To fully benefit from the support that Philips offers, register your product at www.Philips.com/welcome.

2 Important

Read this safety leaflet carefully before you use the electric pressure cooker and save it for future reference.

Danger

- Do not immerse the appliance in water, nor rinse it under the tap.

Warning

- Check if the voltage indicated on the appliance corresponds to the local power voltage before you connect it.
- Only connect the appliance to a grounded power outlet. Always make sure that the plug is inserted firmly into the power outlet.

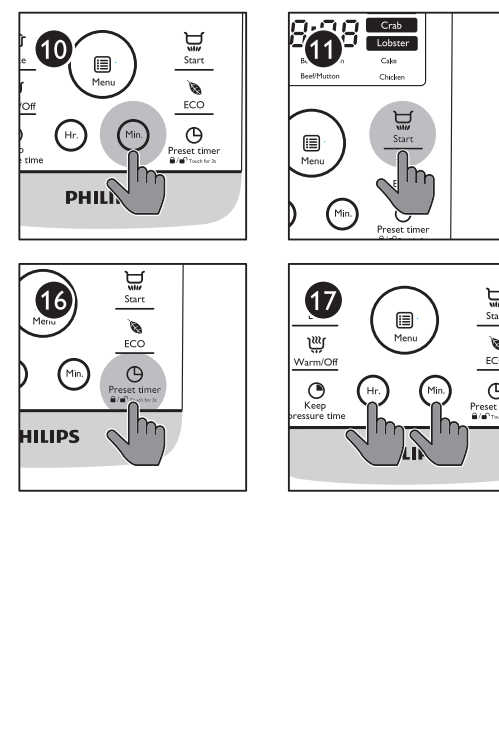
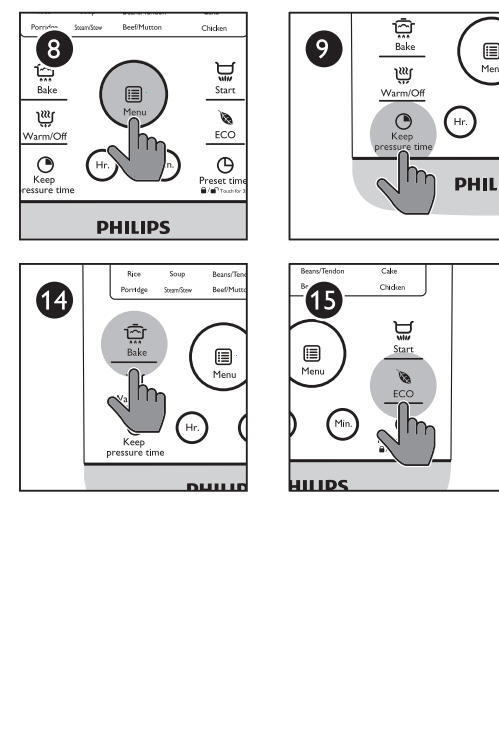
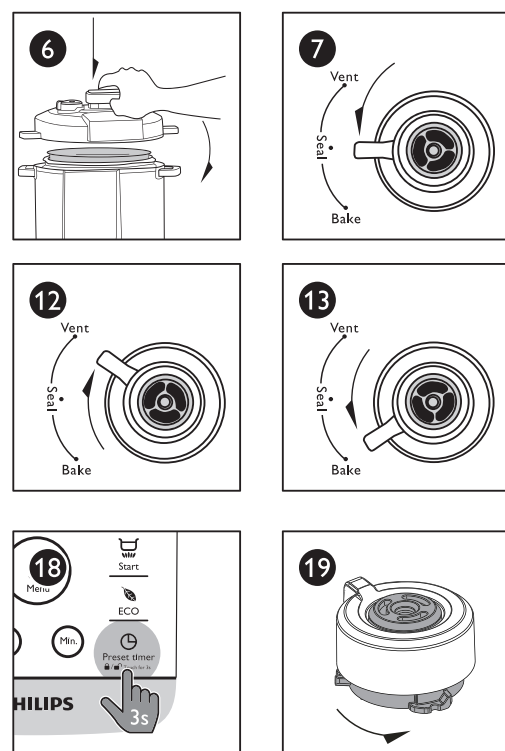
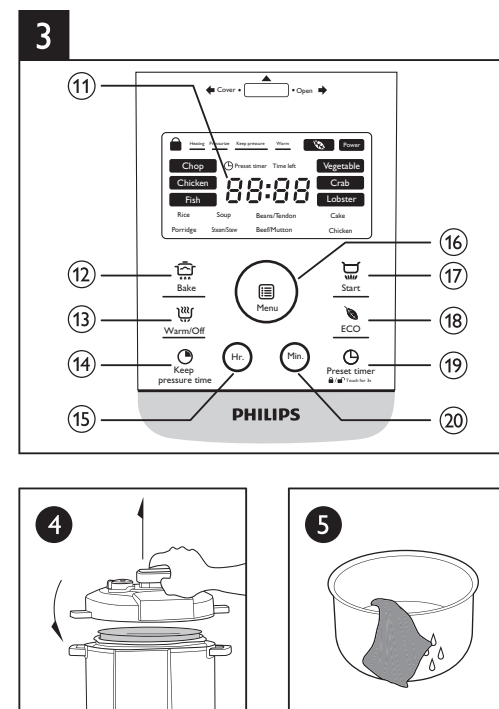
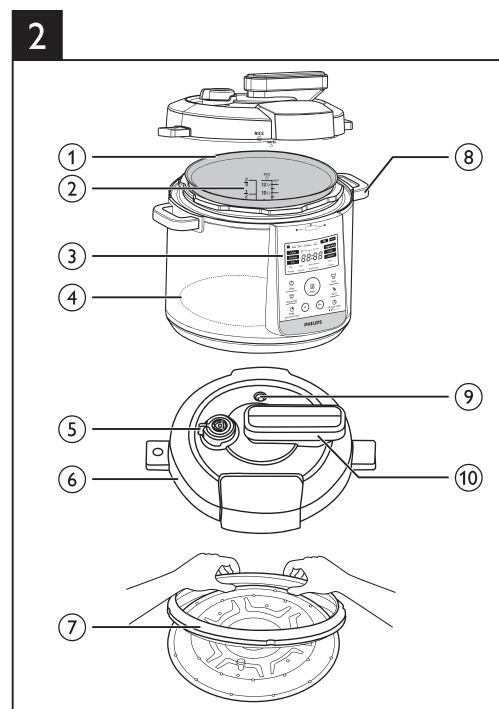
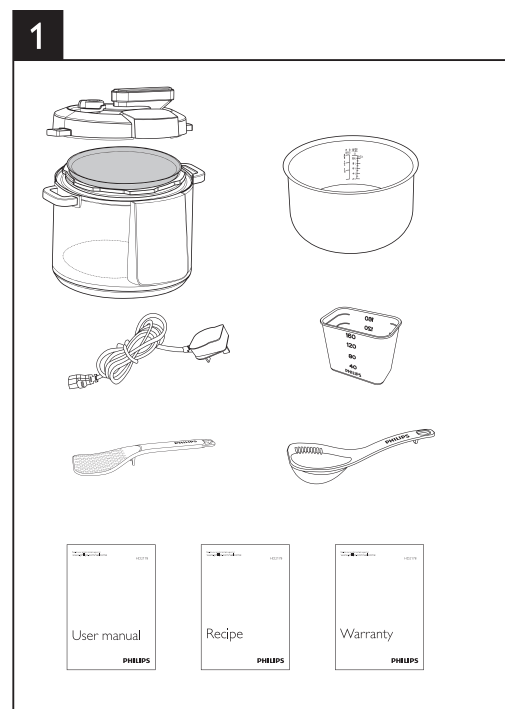

- Do not use the appliance if the plug, the power cord, the inner pot, the sealing ring, or the main body is damaged.
- Make sure that the damaged power cord is replaced by Philips, a service center authorized by Philips or similarly qualified persons in order to avoid a hazard.
- This appliance can be used by children aged from 8 years and above and persons with reduced physical, sensory or mental capabilities or lack of experience and knowledge if they have been given supervision or instruction concerning use of the appliance in a safe way and understand the hazards involved. Children shall not play with the appliance. Cleaning and user maintenance shall not be made by children without supervision.
- This appliance shall not be used by children. Keep the appliance and its cord out of reach of children. Do not let the power cord hang over the edge of the table or worktop on which the appliance stands.
- Make sure the heating element, the temperature sensor, and the outside of the inner pot are clean and dry before you put the plug in the power outlet.

- The heating element surface is subject to residual heat after use.
- Do not plug in the appliance or turn the control knob with wet hands.
- The appliance is not intended to be operated by means of an external timer or a separate remote-control system.
- The ducts in the pressure regulator allowing the escape of steam should be checked regularly to ensure that they are not blocked.
- Make sure the power socket is clean and dry before you plug in the appliance.
- The container must not be opened until the pressure has decreased sufficiently.
- Do not use the appliance if too much air or steam is leaking from under the top lid.
- When cooking soup or viscous liquid, do not release pressure by turning the pressure regulator to the steam vent position, otherwise liquid might spurt from the pressure regulator. Wait until the pressure is naturally released and the floater has dropped to open the top lid.
- Make sure to avoid spillage on the power connector to avoid a potential hazard.

- Make sure to follow the instructions in the user manual to avoid a potential hazard.

Caution

- Never use any accessories or parts from other manufacturers or that Philips does not specifically recommend. If you use such accessories or parts, your guarantee becomes invalid.
- Do not expose the appliance to high temperatures, nor place it on a working or still hot stove or cooker.
- Do not expose the appliance to direct sunlight.
- Place the appliance on a stable, horizontal, and level surface.
- Do not use the handle on the top lid to move the appliance, use the side handles instead.
- When pressure is being released from the pressure regulator, hot steam or liquid will be ejected. Keep hands and face away from the steam vent.
- Always put the inner pot in the appliance before you put the plug in the power outlet and switch it on.
- Do not place the inner pot directly over an open fire to cook food.

- Do not use the inner pot if it is deformed.
- Make sure that the sealing ring is clean and in good condition.
- The accessible surfaces may become hot when the appliance is operating. Take extra caution when touching the surfaces.
- Beware of hot steam coming out of the floating valve and pressure regulator during cooking or when you open the lid. Keep hands and face away from the appliance to avoid the steam.
- Do not lift and move the appliance while it is operating.
- Do not exceed the maximum water level indicated in the inner pot to prevent overflow.
- Do not place the cooking utensils inside the pot while cooking.
- Only use the cooking utensils provided. Avoid using sharp utensils.
- To avoid scratches, it is not recommended to cook ingredients with crustaceans and shellfish. Remove the hard shells before cooking.
- Do not place a magnetic substance on the lid. Do not use the appliance near a magnetic substance.
- Always let the appliance cool down to room temperature before you clean or move it.
- Always clean the appliance after use. Do not clean the appliance in dishwasher.
- Always unplug the appliance if not used for a longer period.
- The appliance is intended to be used in household or similar applications such as:
 - staff kitchen areas in shops, offices, and other residential type environments;
 - farm houses;
 - by clients in hotels, motels and other residential type environments;
 - bed and breakfast type environments.
- If the appliance is used improperly or for professional or semi-professional purposes, or if it is not used according to the instructions in this safety leaflet, the guarantee becomes invalid and Philips refuses liability for any damage caused.

Electromagnetic fields (EMF)

This Philips appliance complies with all applicable standards and regulations regarding exposure to electromagnetic fields.

3 What's in the box (fig. 1)

Electric pressure cooker main unit	Inner pot
Rice spoon	Soup ladle
Measuring cup	User manual
Warranty card	Power cord
Recipe	

Overview (fig. 2)

① Inner pot	⑥ Top lid
② Water level indication	⑦ Sealing ring
③ Control panel	⑧ Main unit handle
④ Heating element	⑨ Floating valve
⑤ Pressure regulator	⑩ Lid handle

Controls overview (fig. 3)

⑪ Display screen	⑱ Menu button
⑭ Bake button	⑲ Start button
⑮ Warm/off button	⑳ Eco button
⑯ Keep pressure time button	㉑ Preset timer button
⑰ Hour button	㉒ Minute button

Before first use

- 1 Remove all packaging materials from the appliance.
- 2 Take out all the accessories from the inner pot.
- 3 Clean the parts of the electric pressure cooker thoroughly before using it for the first time (see chapter 'Cleaning').

Note

- Make sure all parts are completely dry before you start using the electric pressure cooker.

3 Using the electric pressure cooker

Preparations before cooking

Before using the electric pressure cooker to cook food, you need to follow below preparations:

- 1 Hold the lid handle and turn it anti-clockwise until the top lid cannot move any more, then lift up the top lid (fig. 4).
- 2 Take out the inner pot from the electric pressure cooker and put the pre-washed food in the inner pot.

Note

- Do not fill the inner pot with less than 1/3 or more than 2/3 full of food and liquid.
- For food that expands during cooking, do not fill the inner pot with more than 1/2 full of food and liquid.
- For rice cooking, follow the water level indications on the inside of the inner pot. You can adjust the water level for different types of rice and your own preference. Do not exceed the maximum water level indication.
- Make sure the floater falls down before cooking.

- 3 Wipe the outside of the inner pot dry (fig. 5) and put it back into the electric pressure cooker.
- 4 Place the top lid onto the electric pressure cooker and turn it clockwise (fig. 6). You will hear a "click" sound when the top lid is properly locked.



Note

- Make sure the sealing ring is properly assembled around the inside of the top lid.
- Make sure the pressure regulator and floating valve are clean and not blocked.
- Make sure the outside of the inner pot is dry and clean, and that there is no foreign residue on the heating element.
- Make sure the inner pot is in proper contact with the heating element.

Pressure cooking

Note

- Make sure the floater drops down before cooking.

- 1 Follow the steps in "Preparations before cooking".
- 2 Turn the pressure regulator to the seal position (fig. 7).
- 3 Put the plug in the power socket.
- 4 Press the desired cooking function button to choose a cooking mode by pressing the menu button () (fig. 8).
 - ↳ The selected cooking mode indicator flashes.
 - ↳ The default pressure keeping time is displayed on the screen.
- 5 If you want to set a different pressure keeping time, press the keep pressure time button () (fig. 9).
 - ↳ The pressure keeping time flashes on the screen.
- 6 Press the minute button (**Min.**) to set the minute unit (fig. 10).
- 7 Press the start button () and the electric pressure cooker starts working in the selected mode (fig. 11).
 - ↳ You will hear two beeps after you press the start button.
- 8 When the electric pressure cooker reaches the working pressure, the pressure keeping time starts to count down.

- 9 When the pressure keeping time has elapsed, you will hear two beeps and the electric pressure cooker switches to keep-warm mode automatically.
 - ↳ The keep warm indicator lights up.
- 10 Turn the pressure regulator to the vent position (fig. 12).
 - ↳ The electric pressure cooker starts releasing pressure.
 - ↳ The floater drops when the pressure is released sufficiently.
- 11 Hold the top lid handle and turn the lid anti-clockwise until it cannot move any more, then lift it up (fig. 4).

Note



- When cooking soup or viscous liquid, do not release pressure by turning the pressure regulator to the steam vent position, otherwise liquid might spurt from the pressure control valve. Wait until the pressure is naturally released and the floater has dropped to open the top lid.
- After the cooking is finished and the pressure is released, unplug the electric pressure cooker to turn off the keep warm function or when not in use.
- You can press the Warm/Off button to cancel the cooking process.

Tip

- You can adjust the pressure keeping time for different types of food according to your preference. Pressure keeping time is not adjustable for rice cooking function.



Baking

You can cook food without adding water in the inner pot.

- 1 Follow the steps in "Preparations before cooking".
- 2 Turn the pressure regulator to the bake position (fig. 13).
- 3 Put the plug in the power socket.
- 4 Press the baking function button () to choose a desired baking mode (fig. 14).
 - ↳ The selected baking mode indicator flashes.
 - ↳ The default baking time is displayed on the screen.
- 5 If you want to set a different baking time, press the keep pressure time button () (fig. 9).
 - ↳ The pressure keeping time flashes on the screen.
- 6 Press the minute button (**Min.**) to set the minute unit (fig. 10).
- 7 Press the start button () and the electric pressure cooker starts working in the selected mode (fig. 11).
 - ↳ You will hear two beeps after you press the start button.
- 8 When the electric pressure cooker reaches the working temperature, the pressure keeping time starts to count down.
- 9 When the baking is finished, you will hear two beeps and the electric pressure cooker switches to keep-warm mode automatically.
- 10 Turn the pressure regulator to the vent position (fig. 12).
 - ↳ The electric pressure cooker starts releasing pressure.
 - ↳ The floater drops when the pressure is released sufficiently.
- 11 Hold the top lid handle and turn the lid anti-clockwise until it cannot move any more, then lift it up (fig. 4).

Cooking food in ECO mode

You can cook food in ECO mode, but you cannot preset the delayed cooking time in ECO mode.



- 1 Press the ECO button () (fig. 15) for one second.
 - ↳ The electric pressure cooker enters the rice cooking mode by default.
- 2 If you want to choose other cooking mode, press the menu button () to the desired cooking mode (fig. 8).
- 3 Press the minute button (**Min.**) to set the minute unit (fig. 10).
- 4 Press the ECO button () (fig. 15) for one second and the electric pressure cooker starts working in the selected mode.

Note

- The ECO cooking mode cannot be preset.
- The ECO button is not responsive during cooking process.



Preset time for delayed cooking

You can preset the delayed cooking time for different cooking functions. The preset timer is available up to 24 hours, but is not applicable to the cake baking function.

- 1 Choose the desired cooking mode, then press the preset timer button () (fig. 16).
- 2 Press the hour button (**Hr.**) and minute button (**Min.**) to choose the preset time (fig. 17).
- 3 Once the preset time is set, press the start button () to enter preset mode (fig. 11).
 - ↳ The remaining preset time is displayed on the screen.
- 4 When the preset time is elapsed, the electric pressure cooker starts working in the selected cooking mode automatically.

Setting up child lock

To protect your child from using the multicooker, you can set up the child lock function.

- Press and hold the preset timer button () for 3 seconds to enter the child lock mode (fig. 18).
 - ↳ The child lock icon appears on the display screen.
- To unlock, press and hold the preset timer button () for 3 seconds again (fig. 18).
 - ↳ The child lock icon disappears from the display screen.

Cooking time regulating range

Cooking function	Pressure keeping	Default pressure keeping time (minute)	Cooking time (minute)
Fish		15	15-59
Chicken		18	18-59
Crab		20	20-59
Vegetable		3	1-59
Chop		23	20-59
Lobster		20	20-59
Rice	√	14	N/A
Soup	√	20	20-59
Chicken	√	15	12-59
Beans/Tendon	√	30	25-59
Congee	√	13	1-59
Steam/Stew	√	20	5-59
Beef/Mutton	√	30	30-59
Cake	√	45	45-59

Assembling and disassembling the pressure regulator

Caution

- Do not disassemble the pressure regulator during cooking. Always unplug the electric pressure cooker and wait until the pressure has been released sufficiently.

To disassemble the pressure regulator:

- 1 Turn the pressure regulator clockwise to the vent position (fig. 12).
- 2 Press down the pressure regulator and turn it clockwise until it cannot move any more, then pull up the pressure regulator.

To assemble the pressure regulator:

- 1 Place the pressure regulator in position (fig. 19) and turn it anti-clockwise to the bake position (fig. 13).

- 2 When the pressure regulator is properly assembled, you will hear a "click" sound.

4 Specifications

Model Number	HD2178
Rated power output	1000W
Rated capacity	6L

Note

- Always unplug the appliance if not used for a longer period.

5 Cleaning and Maintenance

Note

- Unplug the electric pressure cooker before starting to clean it.
- Wait until the electric pressure cooker has cooled down sufficiently before cleaning it.

Interior

Inside of the outer lid and the main body:

- Wipe with wrung out and damp cloth.
- Make sure to remove all the food residues stuck to the electric pressure cooker.

Heating element:

- Wipe with wrung out and damp cloth.
- Remove food residues with wrung out and damp cloth or toothpicks.

Sealing ring:

- Soak in warm water and clean with sponge.

Exterior

Surface of the outer lid and outside of the main body:

- Wipe with a cloth damped with soap water.
- Only use soft and dry cloth to wipe the control panel.
- Make sure to remove all the food residues around the pressure regulator and floating valve.

Pressure control valve and floating valve:

- Disassemble the pressure control valve, soak it in warm water, and clean with sponge.
- Remove food residues in the pressure control valve and floating valve with toothpicks.

Accessories

Rice spoon, soup ladle, and inner pot:

- Soak in hot water and clean with sponge.

6 Environment

Do not throw away the appliance with normal household waste at the end of its life, but hand it in at an official collection point for recycling. By doing this, you can help to preserve the environment. 

7 Guarantee and service

If you need service or information, or if you have a problem, visit the Philips website at www.philips.com or contact the Philips Customer Care Center in your country. You can find its phone number in the worldwide guarantee leaflet. If there is no Customer Care Center in your country, go to your local Philips dealer.

8 Troubleshooting

If your electric pressure cooker does not function properly or if the cooking quality is insufficient, consult the table below. If you are unable to solve the problem, contact a Philips service center or the Consumer Care Center in your country.

Problem	Solution
I have difficulties closing the top lid.	The sealing ring is not well assembled. Make sure the sealing ring is well assembled around the inside of the top lid.
	The floater blocks the locking pin. Push down the floater so that it does not block the locking pin.
I have difficulties opening the top lid after the pressure is released.	The floater has not dropped. Push the floater down.
The food is not cooked.	Make sure that there is no foreign residue on the heating element and the outside of the inner pot before switching the electric pressure cooker on.
	The heating element is damaged, or the inner pot is deformed. Take the cooker to your Philips dealer or a service center authorized by Philips.
Air or steam leaks from under the lid.	The sealing ring is not well assembled. Make sure the sealing ring is well assembled around the inside of the top lid.
	There is food residue in the sealing ring. Make sure the sealing ring is clean. The top lid is not properly closed. Make sure the top lid is properly closed.
Air or steam leaks from the floating valve.	There is food residue in the rubber ring of the floating valve. Clean the rubber ring of the floating valve.
	The rubber ring of the floating valve is broken. Replace the rubber ring.
The floater does not rise after the appliance starts pressurizing.	Make sure there is enough food and water in the inner pot.
	The top lid or the pressure regulator has malfunction. Take the appliance to your Philips dealer or a service center authorized by Philips.
E3 is displayed on the screen.	The temperature inside the inner pot is too high. Wait until it falls down to room temperature.
E1, E2, or E4 is displayed on the screen.	The electric pressure cooker has malfunction. Take the appliance to a Philips dealer or a service center authorised by Philips.