

868 Omni antenna

Antenna kit for LoRa®



Antenna kit for LoRa® with a 6.5 dBi Omni antenna for 824-928 MHz, 1 m long SMA cable, and mechanical holder for quick and easy mast attachment.

After reviewing your suggestions, we went back to the drawing board and redesigned the Antenna kit for LoRa®. The new kit offers significantly higher durability in a smaller package – without sacrificing performance. The improved cable durability and the added IP66 water resistance with protection against powerful jets make this kit an excellent choice for all kinds of marine and coastal projects.

Mount this antenna on a 25-50 mm mast or on the wall and enjoy the superb coverage!

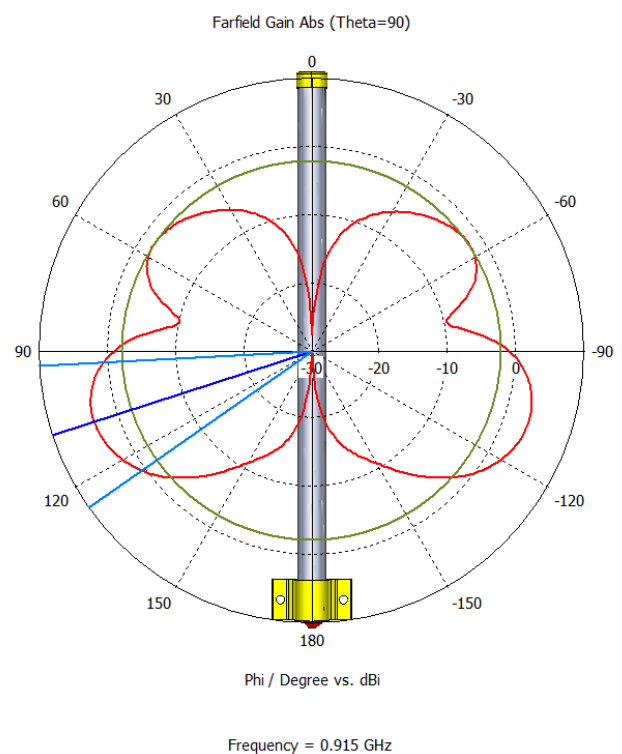
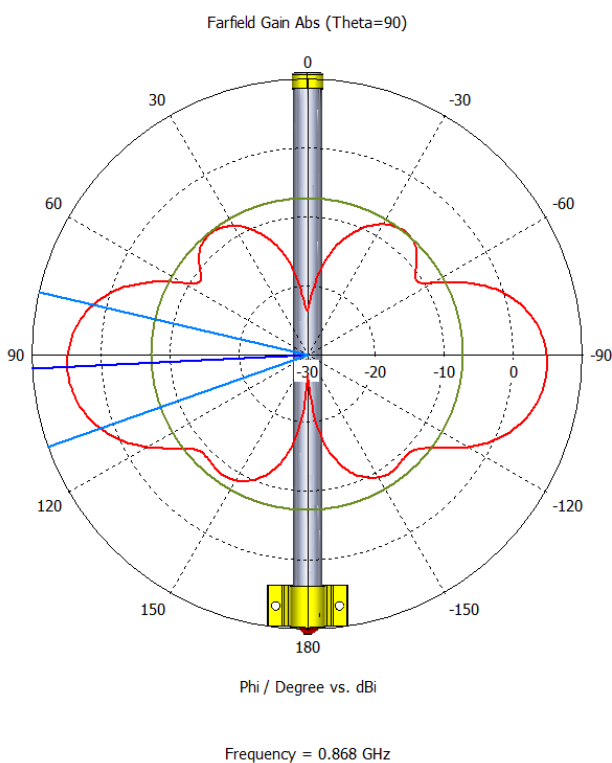

Specifications

Product code	868_Omni_antenna
Frequency	824 - 928 MHz
Peak gain	6.5dBi (868 MHz) / 4.5dBi (915 MHz)
Horizontal beamwidth	360°
Vertical beamwidth	30°
Nominal impedance	50 Ω
Lightning protection	DC ground
Connector	SMA female
Weight	0.6 kg
Dimensions	42 x 68 x 495 mm

Included parts



SMA
cable



Fastening
set