

PRODUCT FAMILY DATASHEET

PANEL VALUE 600

Square recessed panel luminaires, 600 x 600 mm

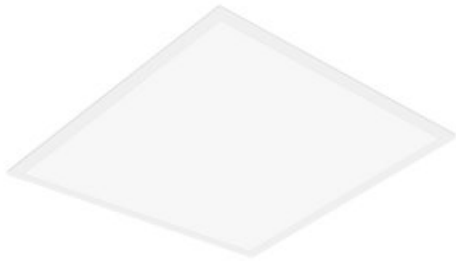

Areas of application

- Direct replacement for luminaires with fluorescent lamps
- Offices, conference rooms
- Reception areas, foyers, corridors, elevators
- Suitable for recessed ceiling systems with grid size of 600 x 600 mm

Product benefits

- Value for money luminaire
- Low flicker light thanks to special electronic control gear
- Energy savings thanks to system efficacy of up to 100 lm/W
- External driver for extended flexibility and easy installation
- Versions with DALI ECG available

Product features

- Lifetime (L70/B50): up to 50,000 h (at 25 °C)
- Extruded aluminum frame
- Polystyrene diffuser



TECHNICAL DATA

Electrical data

Product description	Nominal wattage	Operating mode	Nominal voltage	Nominal current	Inrush current
PANEL VAL 600 36 W 6500 K WT DALI	36.00 W	External LED driver	220...240 V	178 mA	10.4 A
PANEL VAL 600 36 W 6500 K WT	36.00 W	External LED driver	220...240 V	170 mA	10.4 A
PANEL VAL 600 36 W 4000 K WT DALI	36.00 W	External LED driver	220...240 V	178 mA	10.4 A
PANEL VAL 600 36 W 3000 K WT DALI	36.00 W	External LED driver	220...240 V	178 mA	10.4 A
PANEL VAL 600 36 W 4000 K WT	36.00 W	External LED driver	220...240 V	170 mA	10.4 A
PANEL VAL 600 36 W 3000 K WT	36.00 W	External LED driver	220...240 V	170 mA	10.4 A

Product description	Inrush current time T_{h50}	Power factor λ	Mains frequency	Max. no. of lum. on circuit break. B16 A	Max. no. of lum. on circuit break. C10 A
PANEL VAL 600 36 W 6500 K WT DALI	200 μ s	> 0,90	0/50/60 Hz	23	23
PANEL VAL 600 36 W 6500 K WT	200 μ s	> 0,90		19	19
PANEL VAL 600 36 W 4000 K WT DALI	200 μ s	> 0,90	0/50/60 Hz	23	23
PANEL VAL 600 36 W 3000 K WT DALI	200 μ s	> 0,90	0/50/60 Hz	23	23
PANEL VAL 600 36 W 4000 K WT	200 μ s	> 0,90		19	19
PANEL VAL 600 36 W 3000 K WT	200 μ s	> 0,90		19	19

Product description	Max. no. of lum. on circuit break. C16 A	Total harmonic distortion
PANEL VAL 600 36 W 6500 K WT DALI	38	< 15 %
PANEL VAL 600 36 W 6500 K WT	30	< 15 %
PANEL VAL 600 36 W 4000 K WT DALI	38	< 15 %
PANEL VAL 600 36 W 3000 K WT DALI	38	< 15 %
PANEL VAL 600 36 W 4000 K WT	30	< 15 %
PANEL VAL 600 36 W 3000 K WT	30	< 15 %

Luminaire control gear data

Product description	Low flicker
PANEL VAL 600 36 W 6500 K WT DALI	Yes



Product description	Low flicker
PANEL VAL 600 36 W 6500 K WT	Yes
PANEL VAL 600 36 W 4000 K WT DALI	Yes
PANEL VAL 600 36 W 3000 K WT DALI	Yes
PANEL VAL 600 36 W 4000 K WT	Yes
PANEL VAL 600 36 W 3000 K WT	Yes

Photometrical data

Product description	Color temperature	Luminous flux	Luminous efficacy	Light color (designation)	Standard deviation of color matching
PANEL VAL 600 36 W 6500 K WT DALI	6500 K	3600 lm	100 lm/W	Cool Daylight	5 sdc
PANEL VAL 600 36 W 6500 K WT	6500 K	3600 lm	100 lm/W	Cool Daylight	5 sdc
PANEL VAL 600 36 W 4000 K WT DALI	4000 K	3600 lm	100 lm/W	Cool White	5 sdc
PANEL VAL 600 36 W 3000 K WT DALI	3000 K	3600 lm	100 lm/W	Warm White	5 sdc
PANEL VAL 600 36 W 4000 K WT	4000 K	3600 lm	100 lm/W	Cool White	5 sdc
PANEL VAL 600 36 W 3000 K WT	3000 K	3600 lm	100 lm/W	Warm White	5 sdc

Product description	Color rendering index Ra
PANEL VAL 600 36 W 6500 K WT DALI	> 80
PANEL VAL 600 36 W 6500 K WT	> 80
PANEL VAL 600 36 W 4000 K WT DALI	> 80
PANEL VAL 600 36 W 3000 K WT DALI	> 80
PANEL VAL 600 36 W 4000 K WT	> 80
PANEL VAL 600 36 W 3000 K WT	> 80

Light technical data

Product description	Beam angle
PANEL VAL 600 36 W 6500 K WT DALI	120 °
PANEL VAL 600 36 W 6500 K WT	120 °



Product description	Beam angle
PANEL VAL 600 36 W 4000 K WT DALI	120 °
PANEL VAL 600 36 W 3000 K WT DALI	120 °
PANEL VAL 600 36 W 4000 K WT	120 °
PANEL VAL 600 36 W 3000 K WT	120 °

Dimensions & weight

Product description	Length	Height	Width	Mounting length
PANEL VAL 600 36 W 6500 K WT DALI	595.00 mm	35.00 mm	595.00 mm	580 mm
PANEL VAL 600 36 W 6500 K WT	595.00 mm	35.00 mm	595.00 mm	580 mm
PANEL VAL 600 36 W 4000 K WT DALI	595.00 mm	35.00 mm	595.00 mm	580 mm
PANEL VAL 600 36 W 3000 K WT DALI	595.00 mm	35.00 mm	595.00 mm	580 mm
PANEL VAL 600 36 W 4000 K WT	595.00 mm	35.00 mm	595.00 mm	580 mm
PANEL VAL 600 36 W 3000 K WT	595.00 mm	35.00 mm	595.00 mm	580 mm

Product description	Mounting width	Product weight
PANEL VAL 600 36 W 6500 K WT DALI	580 mm	1800.000 g
PANEL VAL 600 36 W 6500 K WT	580 mm	1800.000 g
PANEL VAL 600 36 W 4000 K WT DALI	580 mm	1800.000 g
PANEL VAL 600 36 W 3000 K WT DALI	580 mm	1800.000 g
PANEL VAL 600 36 W 4000 K WT	580 mm	1800.000 g
PANEL VAL 600 36 W 3000 K WT	580 mm	1800.000 g

Product line drawing

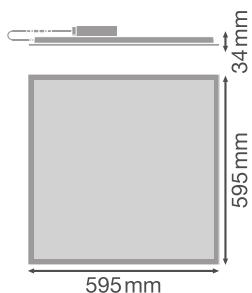

PANEL VAL 600 36 W 3000 K WT

Colors & materials

Product description	Body material	Product color	Housing color	Cover material	Light emitting surface material
PANEL VAL 600 36 W 6500 K WT DALI	Aluminum	White	White	Polystyrene (PS)	Polystyrene
PANEL VAL 600 36 W 6500 K WT	Aluminum	White	White	Polystyrene (PS)	Polystyrene
PANEL VAL 600 36 W 4000 K WT DALI	Aluminum	White	White	Polystyrene (PS)	Polystyrene
PANEL VAL 600 36 W 3000 K WT DALI	Aluminum	White	White	Polystyrene (PS)	Polystyrene
PANEL VAL 600 36 W 4000 K WT	Aluminum	White	White	Polystyrene (PS)	Polystyrene
PANEL VAL 600 36 W 3000 K WT	Aluminum	White	White	Polystyrene (PS)	Polystyrene

Temperatures & operating conditions

Product description	Ambient temperature range
PANEL VAL 600 36 W 6500 K WT DALI	-10...+45 °C
PANEL VAL 600 36 W 6500 K WT	-10...+45 °C
PANEL VAL 600 36 W 4000 K WT DALI	-10...+45 °C
PANEL VAL 600 36 W 3000 K WT DALI	-10...+45 °C
PANEL VAL 600 36 W 4000 K WT	-10...+45 °C
PANEL VAL 600 36 W 3000 K WT	-10...+45 °C

Lifespan

Product description	Number of switching cycles	Lifespan	Lifespan L70/B50 at 25 °C	Lifespan L80/B10 at 25 °C	Lifespan L90/B10 at 25 °C
PANEL VAL 600 36 W 6500 K WT DALI	25000	50000 h	50000 h	50000 h	30000 h
PANEL VAL 600 36 W 6500 K WT	25000	50000 h	50000 h	50000 h	30000 h
PANEL VAL 600 36 W 4000 K WT DALI	25000	50000 h	50000 h	50000 h	30000 h
PANEL VAL 600 36 W 3000 K WT DALI	25000	50000 h	50000 h	50000 h	30000 h
PANEL VAL 600 36 W 4000 K WT	25000	50000 h	50000 h	50000 h	30000 h
PANEL VAL 600 36 W 3000 K WT	25000	50000 h	50000 h	50000 h	30000 h

Additional product data

Product description	Mounting location	Low flicker	Product remark
PANEL VAL 600 36 W 6500 K WT DALI	Ceiling / Wall	Yes	Available from February 2020
PANEL VAL 600 36 W 6500 K WT	Ceiling / Wall	Yes	Available from February 2020
PANEL VAL 600 36 W 4000 K WT DALI	Ceiling / Wall	Yes	Available from February 2020
PANEL VAL 600 36 W 3000 K WT DALI	Ceiling / Wall	Yes	Available from February 2020
PANEL VAL 600 36 W 4000 K WT	Ceiling / Wall	Yes	Available from February 2020
PANEL VAL 600 36 W 3000 K WT	Ceiling / Wall	Yes	Available from February 2020

Capabilities

Product description	Dimmable	Type of connection	ErP LEDmod replaceable	Ball shot safe
PANEL VAL 600 36 W 6500 K WT DALI	Yes	Screwless terminal	Not replaceable	No
PANEL VAL 600 36 W 6500 K WT	No	Screwless terminal	Not replaceable	No
PANEL VAL 600 36 W 4000 K WT DALI	Yes	Screwless terminal	Not replaceable	No
PANEL VAL 600 36 W 3000 K WT DALI	Yes	Screwless terminal	Not replaceable	No
PANEL VAL 600 36 W 4000 K WT	No	Screwless terminal	Not replaceable	No
PANEL VAL 600 36 W 3000 K WT	No	Screwless terminal	Not replaceable	No

Certificates & standards

Product description	Protection class IK (shock resistance)	Glow Wire Test according to IEC 69	Protection class	Type of protection	Standards
PANEL VAL 600 36 W 6500 K WT DALI	IK02	650 °C	II	IP40	CE / CB / EAC / RoHS



Product description	Protection class IK (shock resistance)	Glow Wire Test according to IEC 69	Protection class	Type of protection	Standards
PANEL VAL 600 36 W 6500 K WT	IK02	650 °C	II	IP40	CE / CB / EAC / RoHS
PANEL VAL 600 36 W 4000 K WT DALI	IK02	650 °C	II	IP40	CE / CB / EAC / RoHS
PANEL VAL 600 36 W 3000 K WT DALI	IK02	650 °C	II	IP40	CE / CB / EAC / RoHS
PANEL VAL 600 36 W 4000 K WT	IK02	650 °C	II	IP40	CE / CB / EAC / RoHS
PANEL VAL 600 36 W 3000 K WT	IK02	650 °C	II	IP40	CE / CB / EAC / RoHS

Product description
PANEL VAL 600 36 W 6500 K WT DALI
PANEL VAL 600 36 W 6500 K WT
PANEL VAL 600 36 W 4000 K WT DALI
PANEL VAL 600 36 W 3000 K WT DALI
PANEL VAL 600 36 W 4000 K WT
PANEL VAL 600 36 W 3000 K WT

EQUIPMENT / ACCESSORIES

- Accessories for several mounting options available
- External control gear included
- Security brackets included

APPLICATION ADVICE

For more detailed application information and graphics please see product datasheet.

SALES AND TECHNICAL SUPPORT

Sales and Technical Support www.ledvance.com















COUNTRY SPECIFIC INFORMATION

Product description	Product code	METEL-Code	SEG number	STK number	UK Org
PANEL VAL 600 36 W 6500 K WT DALI	4058075392489	-	7018125	4283687	-



Product description	Product code	METEL-Code	SEG number	STK number	UK Org
PANEL VAL 600 36 W 6500 K WT	4058075392403	-	7018120	4283682	-
PANEL VAL 600 36 W 4000 K WT DALI	4058075392465	-	7018124	4283686	-
PANEL VAL 600 36 W 3000 K WT DALI	4058075392441	-	7018123	4283685	-
PANEL VAL 600 36 W 4000 K WT	4058075392380	-	7018119	4283681	-
PANEL VAL 600 36 W 3000 K WT	4058075392366	-	7018118	4283680	-













DOWNLOAD DATA

DOWNLOAD DATA	
	Tender documents Tender Text 4058075392489
	Declarations of conformity PL VAL DALI
	IES file (IES) PL VAL DALI 600 36W 6500K
	LDT file (Eulumdat) PL VAL DALI 600 36W6500K
	R3D file (Relux 3D Model) PANEL VALUE 600
	M3D file (3D Model) PANEL VALUE 600
	UGR file (UGR table) PL VAL DALI 600 36W 6500K
	User instruction PL VAL UI
	Tender documents Tender Text 4058075392403
	Declarations of conformity PL VAL
	IES file (IES) PL VAL 600 36W 6500K
	LDT file (Eulumdat) PL VAL 600 36W6500K
	R3D file (Relux 3D Model) PANEL VALUE 600
	M3D file (3D Model) PANEL VALUE 600



DOWNLOAD DATA	
	UGR file (UGR table) PL VAL 600 36W 6500K
	Tender documents Tender Text 4058075392465
	Declarations of conformity PL VAL DALI
	IES file (IES) PL VAL DALI 600 36W 4000K
	LDT file (Eulumdat) PL VAL DALI 600 36W4000K
	R3D file (Relux 3D Model) PANEL VALUE 600
	M3D file (3D Model) PANEL VALUE 600
	UGR file (UGR table) PL VAL DALI 600 36W 4000K
	Tender documents Tender Text 4058075392441
	Declarations of conformity PL VAL DALI
	IES file (IES) PL VAL DALI 600 36W 3000K
	LDT file (Eulumdat) PL VAL DALI 600 36W3000K
	R3D file (Relux 3D Model) PANEL VALUE 600
	M3D file (3D Model) PANEL VALUE 600
	UGR file (UGR table) PL VAL DALI 600 36W 3000K
	User instruction PL VAL UI
	Tender documents Tender Text 4058075392380
	Declarations of conformity PL VAL



DOWNLOAD DATA	
	IES file (IES) PL VAL 600 36W 4000K
	LDT file (Eulumdat) PL VAL 600 36W4000K
	R3D file (Relux 3D Model) PANEL VALUE 600
	M3D file (3D Model) PANEL VALUE 600
	UGR file (UGR table) PL VAL 600 36W 4000K
	User instruction PL VAL UI
	Tender documents Tender Text 4058075392366
	Declarations of conformity PL VAL
	IES file (IES) PL VAL 600 36W 3000K
	LDT file (Eulumdat) PL VAL 600 36W3000K
	R3D file (Relux 3D Model) PANEL VALUE 600
	M3D file (3D Model) PANEL VALUE 600
	UGR file (UGR table) PL VAL 600 36W 3000K

LOGISTICAL DATA

Product code	Packaging unit (Pieces/Unit)	Dimensions (length x width x height)	Gross weight	Volume
4058075392489	Folding box 1	602 mm x 40 mm x 648 mm	2192.00 g	15.60 dm ³
4058075392403	Folding box 1	602 mm x 40 mm x 648 mm	2192.00 g	15.60 dm ³
4058075392465	Folding box 1	602 mm x 40 mm x 648 mm	2192.00 g	15.60 dm ³
4058075392441	Folding box 1	602 mm x 40 mm x 648 mm	2192.00 g	15.60 dm ³



Product code	Packaging unit (Pieces/Unit)	Dimensions (length x width x height)	Gross weight	Volume
4058075392380	Folding box 1	602 mm x 40 mm x 648 mm	2192.00 g	15.60 dm ³
4058075392366	Folding box 1	602 mm x 40 mm x 648 mm	2192.00 g	15.60 dm ³

The mentioned product code describes the smallest quantity unit which can be ordered. One shipping unit can contain one or more single products. When placing an order, for the quantity please enter single or multiples of a shipping unit.

ADDITIONAL CATALOG INFORMATION

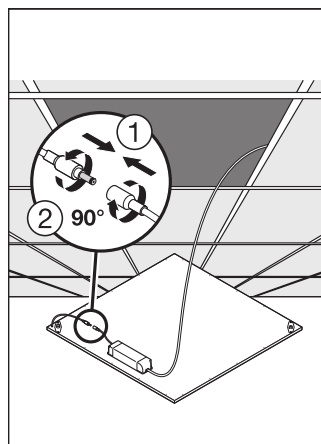
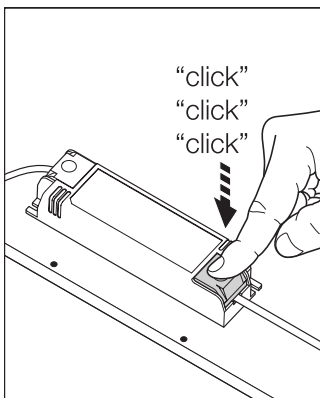
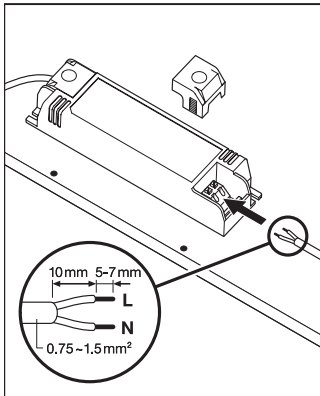
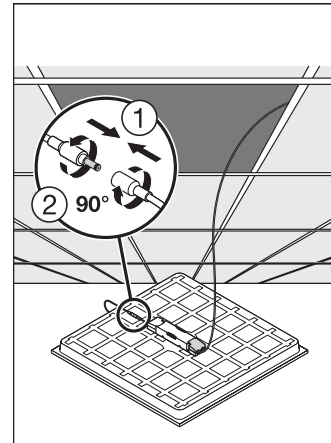
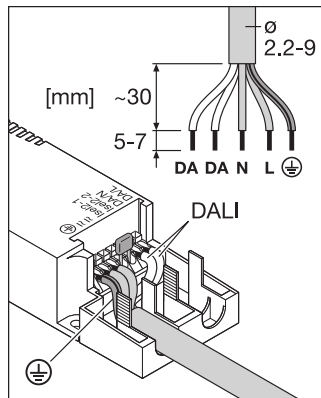
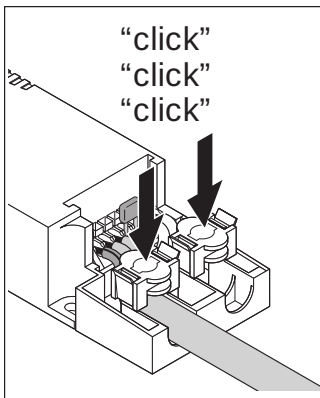

ACCESSORIES OPTIONAL

Product description	Accessory name	Accessory code
PANEL VAL 600 36 W 6500 K WT DALI	SECURITY KIT SECURITY KIT 4x	▶ 4058075472990
PANEL VAL 600 36 W 6500 K WT DALI	SUSPENSION KIT Suspension Kit	▶ 4058075402928
PANEL VAL 600 36 W 6500 K WT DALI	CONNECTOR BOX 5POLE L/N/PE/D+/D- 4x	▶ 4058075473034
PANEL VAL 600 36 W 6500 K WT DALI	RECESSED MOUNT FRAME 600 RECESSED MOUNT FRAME	▶ 4058075402881
PANEL VAL 600 36 W 6500 K WT DALI	SURFACE MOUNT KIT VALUE 600 SURFACE MOUNT KIT H70 VAL	▶ 4058075402843
PANEL VAL 600 36 W 6500 K WT DALI	EMERGENCY CONVERSION BOX CONVERSION BOX	▶ 4058075237025
PANEL VAL 600 36 W 6500 K WT DALI	RECESSED MOUNT CLIPS RECESSED MOUNT CLIPS VAL 4x	▶ 4058075409859
PANEL VAL 600 36 W 6500 K WT DALI	SURFACE MOUNT KIT 600 SURFACE MOUNT KIT H75	▶ 4058075472914
PANEL VAL 600 36 W 6500 K WT	EMERGENCY CONVERSION BOX CONVERSION BOX	▶ 4058075237025
PANEL VAL 600 36 W 6500 K WT	SUSPENSION KIT Suspension Kit	▶ 4058075402928
PANEL VAL 600 36 W 6500 K WT	SECURITY KIT SECURITY KIT 4x	▶ 4058075472990
PANEL VAL 600 36 W 6500 K WT	RECESSED MOUNT CLIPS RECESSED MOUNT CLIPS VAL 4x	▶ 4058075409859
PANEL VAL 600 36 W 6500 K WT	SURFACE MOUNT KIT 600 SURFACE MOUNT KIT H75	▶ 4058075472914
PANEL VAL 600 36 W 6500 K WT	RECESSED MOUNT FRAME 600 RECESSED MOUNT FRAME	▶ 4058075402881
PANEL VAL 600 36 W 6500 K WT	SURFACE MOUNT KIT VALUE 600 SURFACE MOUNT KIT H70 VAL	▶ 4058075402843
PANEL VAL 600 36 W 6500 K WT	CONNECTOR BOX 5POLE L/N 4x	▶ 4058075473010
PANEL VAL 600 36 W 4000 K WT DALI	SURFACE MOUNT KIT VALUE 600 SURFACE MOUNT KIT H70 VAL	▶ 4058075402843
PANEL VAL 600 36 W 4000 K WT DALI	EMERGENCY CONVERSION BOX CONVERSION BOX	▶ 4058075237025
PANEL VAL 600 36 W 4000 K WT DALI	SURFACE MOUNT KIT 600 SURFACE MOUNT KIT H75	▶ 4058075472914
PANEL VAL 600 36 W 4000 K WT DALI	SECURITY KIT SECURITY KIT 4x	▶ 4058075472990
PANEL VAL 600 36 W 4000 K WT DALI	SUSPENSION KIT Suspension Kit	▶ 4058075402928
PANEL VAL 600 36 W 4000 K WT DALI	RECESSED MOUNT CLIPS RECESSED MOUNT CLIPS VAL 4x	▶ 4058075409859
PANEL VAL 600 36 W 4000 K WT DALI	CONNECTOR BOX 5POLE L/N/PE/D+/D- 4x	▶ 4058075473034



Product description	Accessory name	Accessory code
PANEL VAL 600 36 W 4000 K WT DALI	RECESSED MOUNT FRAME 600 RECESSED MOUNT FRAME	▶ 4058075402881
PANEL VAL 600 36 W 3000 K WT DALI	EMERGENCY CONVERSION BOX CONVERSION BOX	▶ 4058075237025
PANEL VAL 600 36 W 3000 K WT DALI	SUSPENSION KIT Suspension Kit	▶ 4058075402928
PANEL VAL 600 36 W 3000 K WT DALI	SURFACE MOUNT KIT VALUE 600 SURFACE MOUNT KIT H70 VAL	▶ 4058075402843
PANEL VAL 600 36 W 3000 K WT DALI	CONNECTOR BOX 5POLE L/N/PE/D+/D- 4x	▶ 4058075473034
PANEL VAL 600 36 W 3000 K WT DALI	SECURITY KIT SECURITY KIT 4x	▶ 4058075472990
PANEL VAL 600 36 W 3000 K WT DALI	SURFACE MOUNT KIT 600 SURFACE MOUNT KIT H75	▶ 4058075472914
PANEL VAL 600 36 W 3000 K WT DALI	RECESSED MOUNT FRAME 600 RECESSED MOUNT FRAME	▶ 4058075402881
PANEL VAL 600 36 W 3000 K WT DALI	RECESSED MOUNT CLIPS RECESSED MOUNT CLIPS VAL 4x	▶ 4058075409859
PANEL VAL 600 36 W 4000 K WT	RECESSED MOUNT FRAME 600 RECESSED MOUNT FRAME	▶ 4058075402881
PANEL VAL 600 36 W 4000 K WT	SECURITY KIT SECURITY KIT 4x	▶ 4058075472990
PANEL VAL 600 36 W 4000 K WT	SUSPENSION KIT Suspension Kit	▶ 4058075402928
PANEL VAL 600 36 W 4000 K WT	SURFACE MOUNT KIT VALUE 600 SURFACE MOUNT KIT H70 VAL	▶ 4058075402843
PANEL VAL 600 36 W 4000 K WT	SURFACE MOUNT KIT 600 SURFACE MOUNT KIT H75	▶ 4058075472914
PANEL VAL 600 36 W 4000 K WT	CONNECTOR BOX 5POLE L/N 4x	▶ 4058075473010
PANEL VAL 600 36 W 4000 K WT	RECESSED MOUNT CLIPS RECESSED MOUNT CLIPS VAL 4x	▶ 4058075409859
PANEL VAL 600 36 W 4000 K WT	EMERGENCY CONVERSION BOX CONVERSION BOX	▶ 4058075237025
PANEL VAL 600 36 W 3000 K WT	SECURITY KIT SECURITY KIT 4x	▶ 4058075472990
PANEL VAL 600 36 W 3000 K WT	RECESSED MOUNT FRAME 600 RECESSED MOUNT FRAME	▶ 4058075402881
PANEL VAL 600 36 W 3000 K WT	SUSPENSION KIT Suspension Kit	▶ 4058075402928
PANEL VAL 600 36 W 3000 K WT	EMERGENCY CONVERSION BOX CONVERSION BOX	▶ 4058075237025
PANEL VAL 600 36 W 3000 K WT	CONNECTOR BOX 5POLE L/N 4x	▶ 4058075473010
PANEL VAL 600 36 W 3000 K WT	RECESSED MOUNT CLIPS RECESSED MOUNT CLIPS VAL 4x	▶ 4058075409859
PANEL VAL 600 36 W 3000 K WT	SURFACE MOUNT KIT 600 SURFACE MOUNT KIT H75	▶ 4058075472914
PANEL VAL 600 36 W 3000 K WT	SURFACE MOUNT KIT VALUE 600 SURFACE MOUNT KIT H70 VAL	▶ 4058075402843

References / Links

– For Guarantee see www.ledvance.com/guarantee



DISCLAIMER

Subject to change without notice. Errors and omission excepted. Always make sure to use the most recent release.

