

Always there to help you

Register your product and get support at
www.philips.com/support



HTL2163B



Quick start guide

PHILIPS



- EN** Before using your product, read all accompanying safety information
- CS** Před použitím produktu si přečtěte doprovodné bezpečnostní informace
- DA** Læs alle medfølgende sikkerhedsoplysninger, inden du tager produktet i brug
- DE** Lesen Sie vor Verwendung dieses Produkts alle begleitenden Sicherheit-sinformationen
- EL** Πριν χρησιμοποιήσετε το προϊόν, διαβάστε όλες τις παρεχόμενες πληροφορίες ασφάλειας
- ES** Antes de usar el producto, lea toda la información de seguridad adjunta
- FI** Lue kaikki turvallisuu tiedot ennen tuotteen käyttöä
- FR** Avant d'utiliser votre produit, lisez l'intégralité des consignes de sécurité jointes
- HU** A termék használatá előtt alaposan olvassa el a mellékelt biztonsági tudnivalókat
- IT** Prima di utilizzare il prodotto, leggere tutte le relative informazioni sulla sicurezza
- NL** Lees voordat u het product gaat gebruiken eerst alle bijbehorende veiligheidsinformatie
- NO** Les all vedlagt sikkerhetsinformasjon før du bruker produktet
- PL** Przed rozpoczęciem korzystania z produktu należy zapoznać się z informacjami dotyczącymi bezpieczeństwa
- PT** Antes de utilizar o produto, leia todas as informações de segurança que o acompanham
- RO** Înainte de a utiliza acest produs, citiți toate informațiile de siguranță care îl însoțesc
- SK** Pred použitím produktu si prečítajte všetky sprievodné bezpečnostné informácie maklumat keselamatan yang disertakan
- SV** Innan du använder produkten ska du läsa all tillhörande säkerhetsinformation
- TR** Ürününüzü kullanmadan önce ilgili tüm güvenlik bilgilerini okuyun

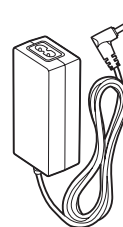
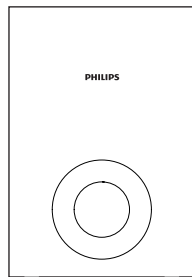

Power Adapter

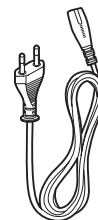

Power Cord



Cable Tie

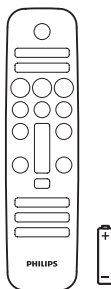

4 X

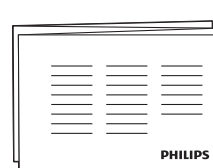

1

EN Assemble your SoundBar / Position the SoundBar

CS Sestavte zařízení SoundBar. / Umístění zařízení SoundBar

DA Saml SoundBar. / Placer din SoundBar

DE Sicherheitsinformationen. / Positionieren des SoundBars

EL Συναρμολογήστε το SoundBar. / Τοποθέτηση του SoundBar

ES Montaje del SoundBar. / Colocación del SoundBar

FI SoundBarin kokoaminen. / SoundBarin sijoittaminen

FR Assemblage de votre barre de son. / Placer la barre de son

HU Rakja össze a SoundBar rendszert. / A SoundBar elhelyezése

IT Assemblaggio della SoundBar. / Posizionamento della SoundBar

NL Zet de SoundBar in elkaar. / De SoundBar plaatsen

NO Monter SoundBar. / Plasser SoundBar

PL Montaż zestawu SoundBar. / Ustawianie zestawu SoundBar

PT Montar o seu SoundBar. / Posicionar o SoundBar

RO Asamblarea SoundBar-ului. / Poziționare SoundBar

SK Poskladajte zariadenie SoundBar. / Umiestnite zariadenie SoundBar

SV Montera Soundbar. / Placera SoundBar

TR SoundBar'ınızı monte edin. / SoundBar'ı yerleştirin

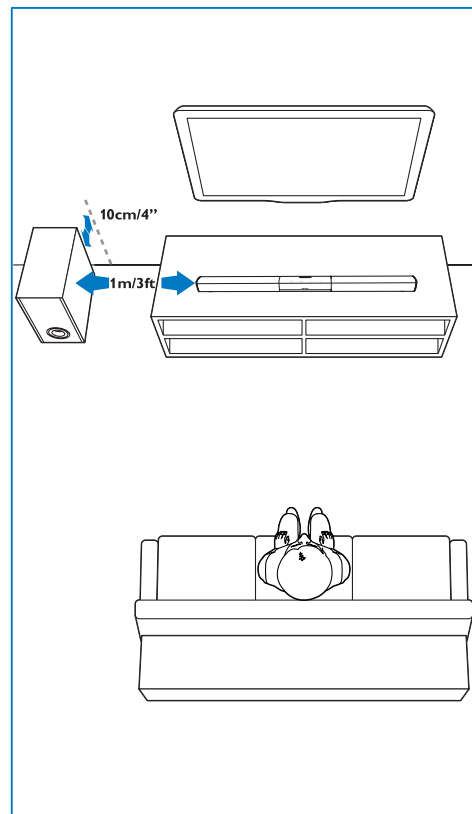
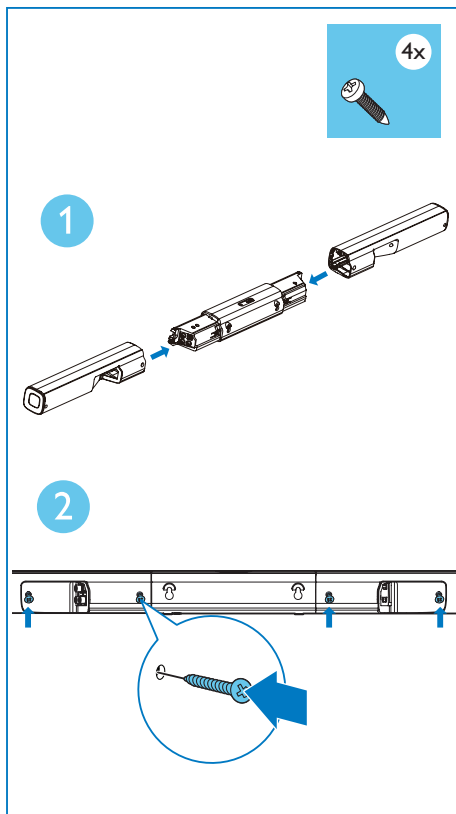

- EN** Wall mount the SoundBar (optional)
- CS** Montáž zařízení SoundBar na stěnu (volitelné)
- DA** Monter din SoundBar på væggen (valgfrit)
- DE** Wandmontage des SoundBars (optional)
- EL** Επιτοίχια τοποθέτηση του SoundBar (προαιρετικά)
- ES** Montaje en pared del SoundBar (opcional)
- FI** SoundBarin kiinnittäminen seinään (valinnainen)
- FR** Fixer la barre de son sur un mur (facultatif)
- HU** A SoundBar fali rögzítése (opcionális)
- IT** Montaggio a parete della SoundBar (opzionale)
- NL** De SoundBar aan de wand bevestigen (optioneel)
- NO** Monter SoundBar på veggene (valgfritt)
- PL** Montaż naścienny zestawu SoundBar (opcjonalnie)
- PT** Montar o SoundBar na parede (opcional)
- RO** Montare pe perete SoundBar (opțional)
- SK** Upevnite zariadenie SoundBar na stenu (voliteľné)
- SV** Vägghmontera SoundBar (valfritt)
- TR** SoundBar'ı duvara monte edin (isteğe bağlı)

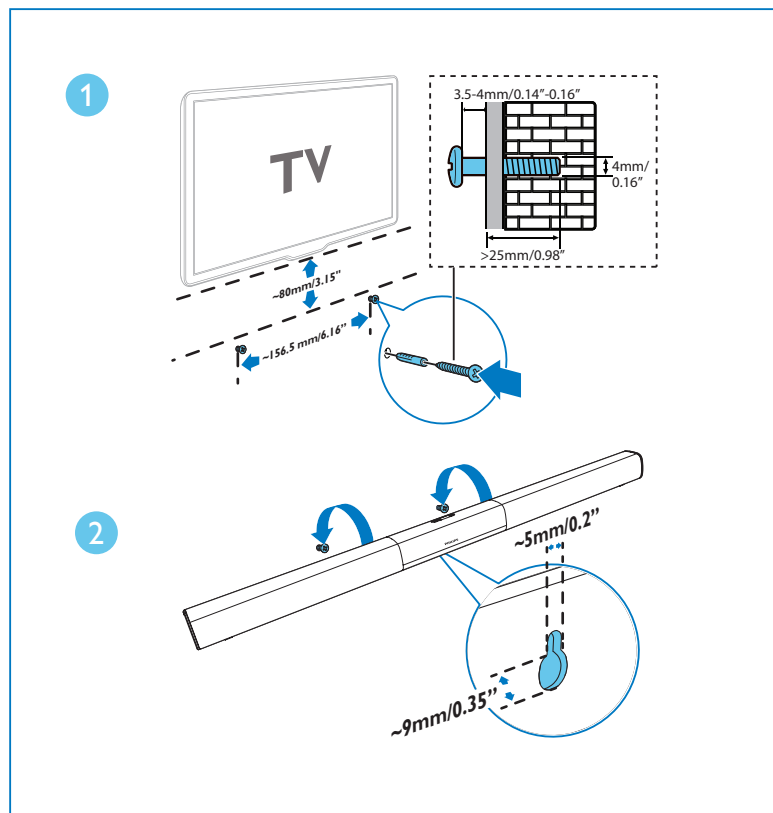

2

- EN** Connect the SoundBar
- CS** Připojení zařízení SoundBar
- DA** Tilslut din SoundBar
- DE** Anschließen des SoundBars
- EL** Σύνδεση του SoundBar
- ES** Conexión del SoundBar
- FI** SoundBarin liittäminen
- FR** Connecter la barre de son
- HU** A SoundBar csatlakoztatása
- IT** Collegamento della SoundBar
- NL** De SoundBar aansluiten
- NO** Koble til SoundBar
- PL** Podłączenie zestawu SoundBar
- PT** Ligar os cabos do SoundBar
- RO** Conectare SoundBar
- SK** Pripojte zariadenie SoundBar
- SV** Ansluta SoundBar
- TR** SoundBar'ı bağlayın

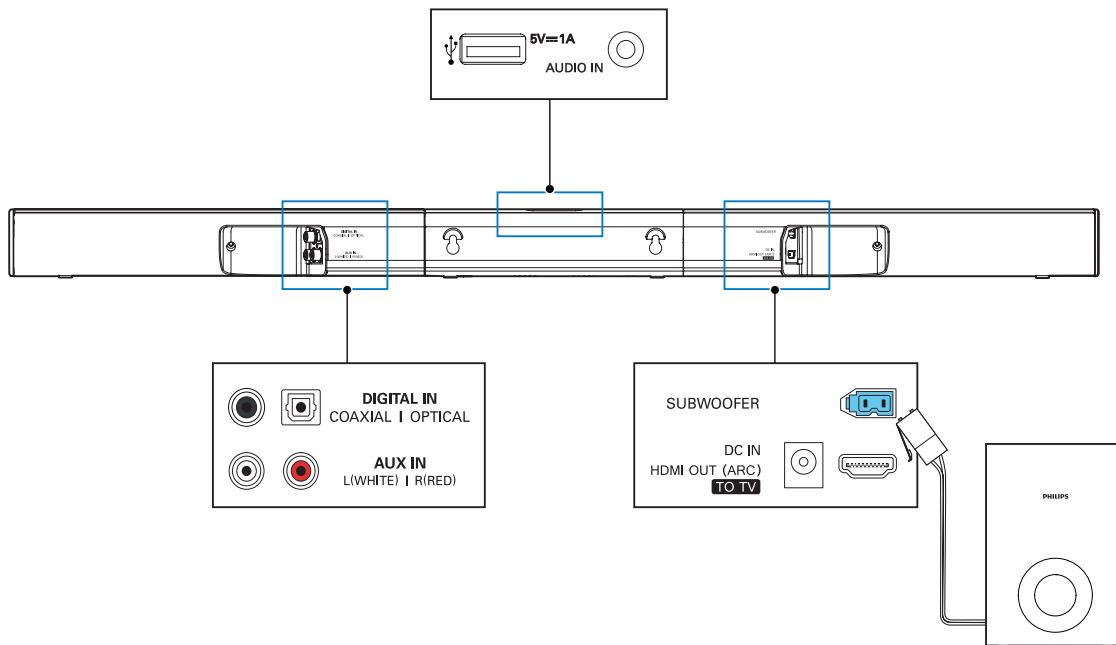

3

EN Hear audio from TV in one of the following ways

CS Zvuk můžete poslouchat z televizoru jedním z následujících způsobů

DA Hør lyd fra tv'et på en af følgende måder

DE Genießen Sie den Ton Ihres Fernsehers auf eine der folgenden Arten

EL Ακούστε τον ήχο από την τηλεόραση με έναν από τους παρακάτω τρόπους

ES Escuche el audio del televisor utilizando uno de los métodos siguientes

FI Kuuntele television ääntä jollakin seuraavista tavoista

FR Vous pouvez lire du contenu audio à partir du téléviseur de plusieurs façons

HU A televízió hangja a következő módok valamelyikén hallgatható

IT È possibile ascoltare l'audio dal televisore in uno dei modi indicati di seguito

NL Het TV-geluid beluisteren op een van deze manieren

NO Hør lyd fra TV-en på en av følgende måter

PL Odtwarzaj dźwięk z telewizora w następujący sposób

PT Ouvir áudio no televisor de uma das seguintes formas

RO Beneficiați de conținutul audio de la TV într-unul dintre următoarele moduri

SK Zvuk z televizora môžete prehrávať niekoľkými spôsobmi

SV Spela upp TV-ljud på ett av följande sätt

TR TV'den ses almak için aşağıdaki yöntemlerden birini kullanın

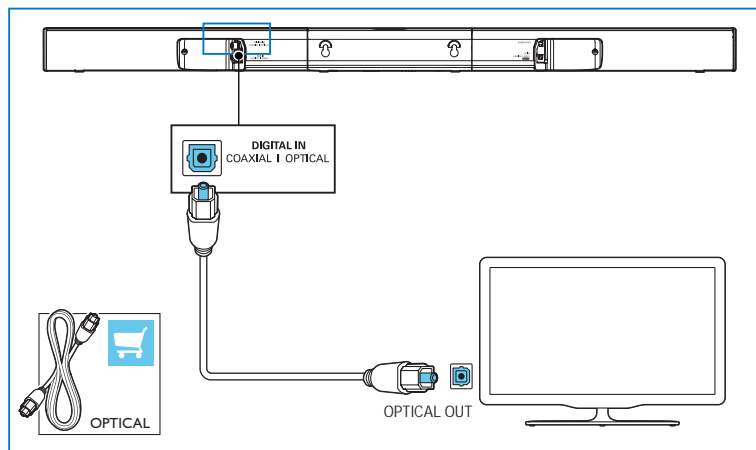
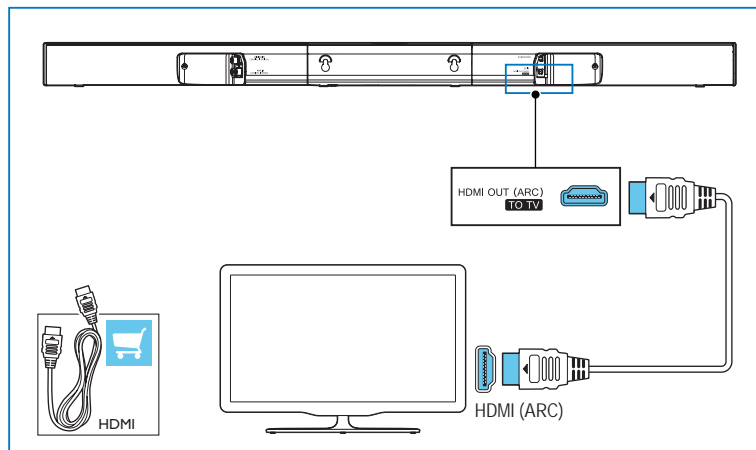

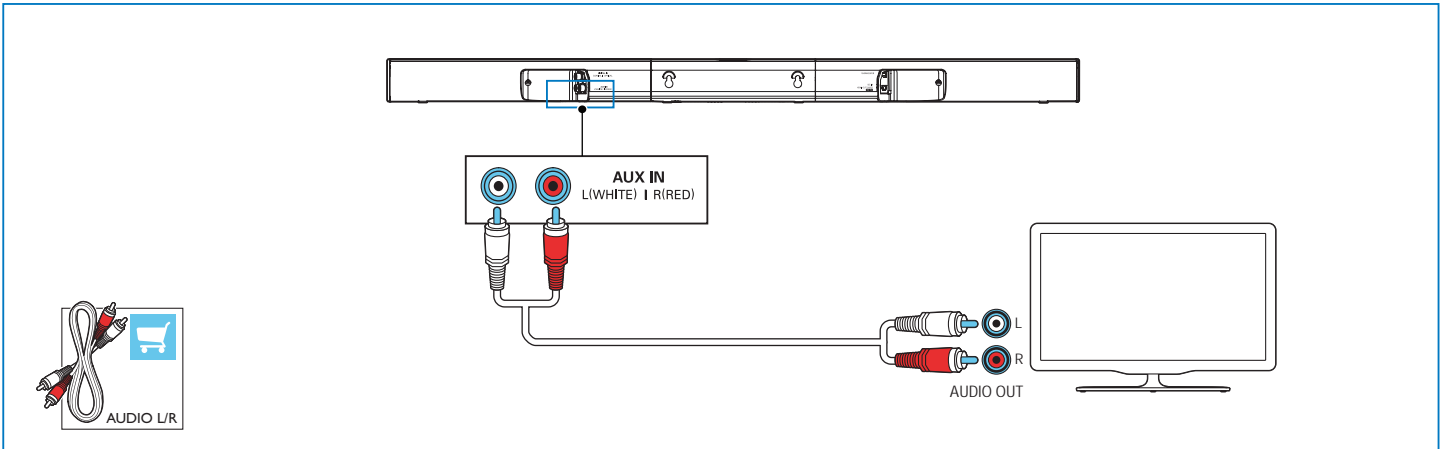
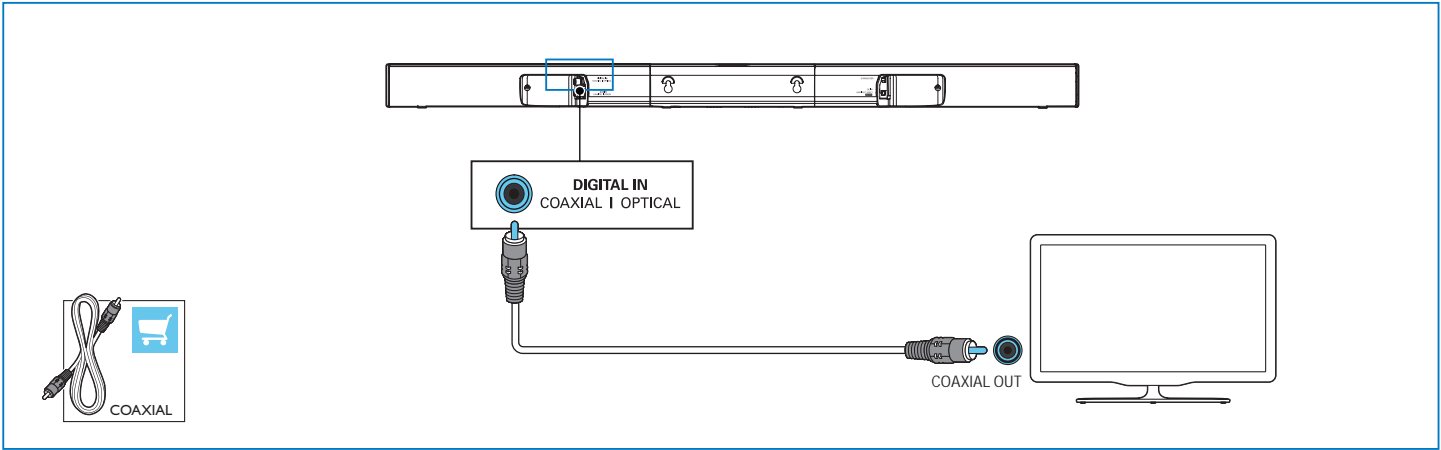

4

- EN** Switch on the SoundBar
- CS** Zapnutí zařízení SoundBar
- DA** Tænd for din SoundBar
- DE** Einschalten des SoundBars
- EL** Ενεργοποίηση του SoundBar
- ES** Encendido del SoundBar
- FI** SoundBarin käynnistäminen
- FR** Allumer la barre de son
- HU** A SoundBar bekapcsolása
- IT** Accensione della SoundBar
- NL** De SoundBar inschakelen
- NO** Slå på SoundBar
- PL** Włączanie zestawu SoundBar
- PT** Ligar o SoundBar
- RO** Pornire SoundBar
- SK** Zapnite zariadenie SoundBar
- SV** Slå på SoundBar
- TR** SoundBar'ı açın

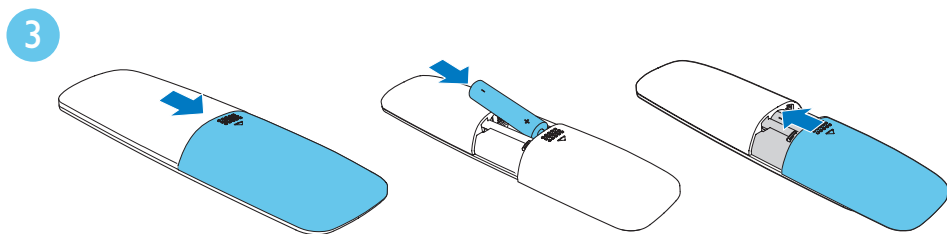
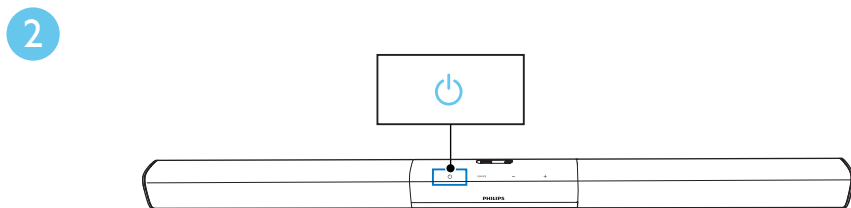
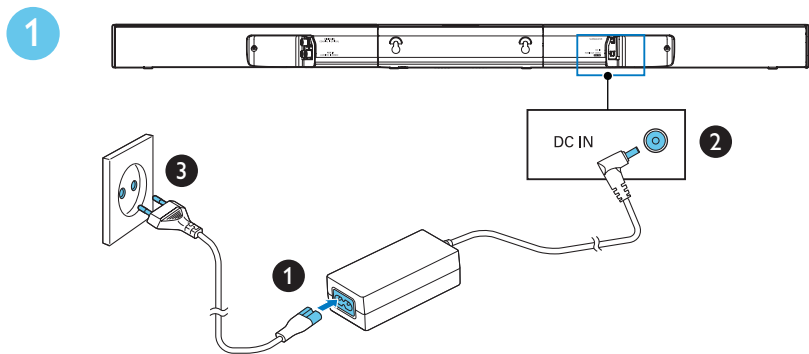

5

- EN** Select the correct audio source
- CS** Zvolte správný zdroj zvuku
- DA** Vælg den korrekte lydkilde
- DE** Korrekte Audioquelle wählen
- EL** Επιλέξτε τη σωστή πηγή ήχου
- ES** Seleccione la fuente de audio correcta
- FI** Valitse oikea äänilähde
- FR** Sélectionner la source audio adéquate
- HU** Válassza ki a megfelelő hangforrást
- IT** Selezionare la sorgente audio corretta
- NL** De juiste audiobron selecteren
- NO** Velg riktig lydkilde
- PL** Wybierz prawidłowe źródło audio
- PT** Selecionar a fonte de áudio correcta
- RO** Selectarea sursei audio corecte
- SK** Výber správneho zdroja zvuku
- SV** Välj korrekt ljudkälla
- TR** Doğru ses kaynağını seçme

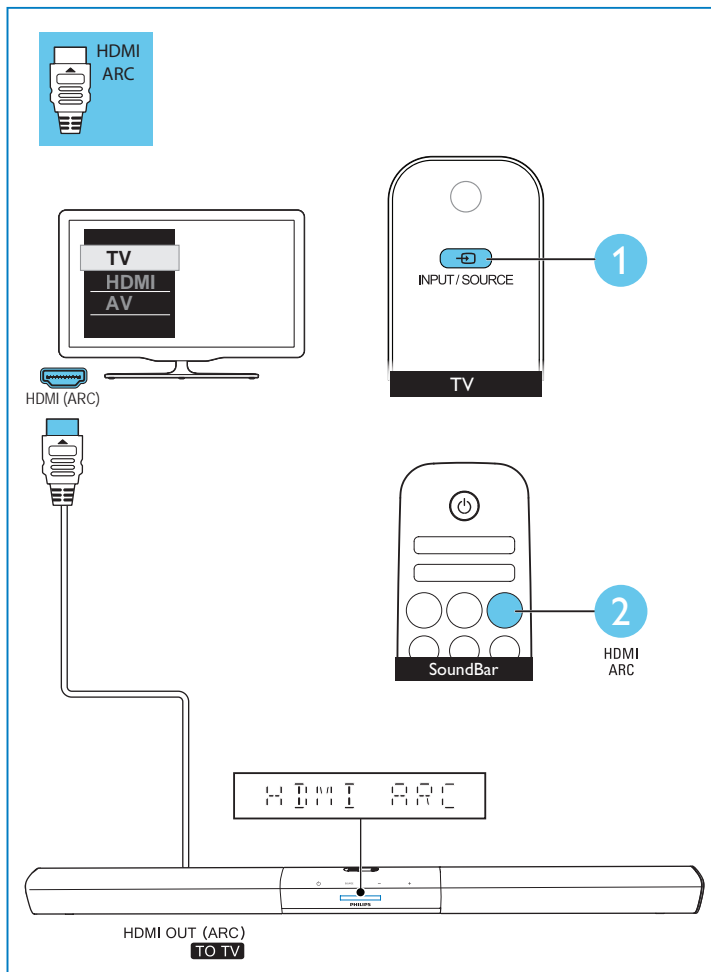

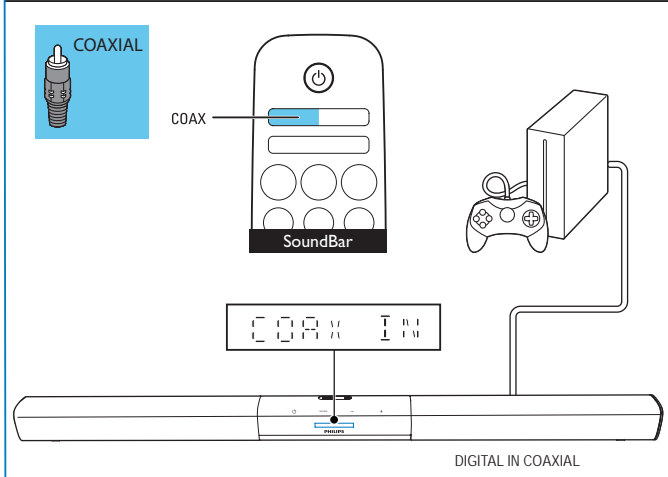
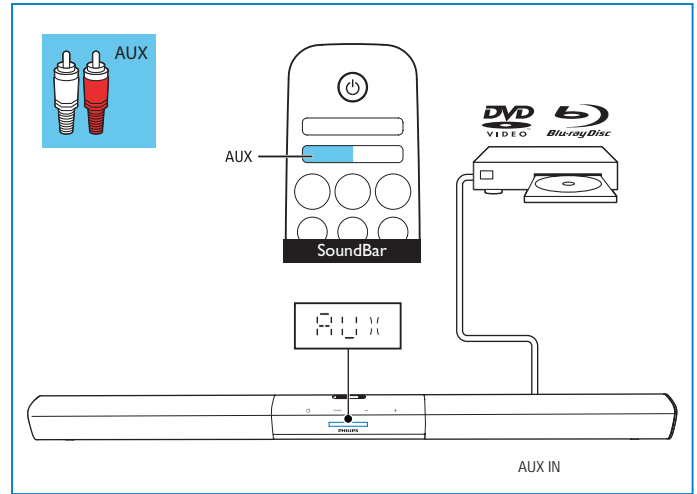
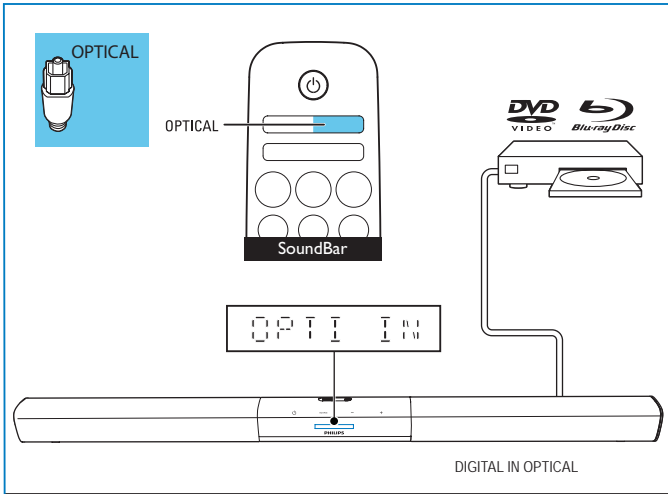

6

EN Play other devices

CS Spusťte z jiného zařízení

DA Afspil fra andre enheder

DE Andere Geräte abspielen

EL Εκτελέστε αναπαραγωγή άλλων συσκευών

ES Reproduzca otros dispositivos

FI Toista muilla laitteilla

FR Lire d'autres périphériques

HU Játsszon le másfélel más készülékekről

IT Riproduzione di altri dispositivi

NL Andere apparaten afspelen

NO Spill av fra andre enheter

PL Odtwarzaj z innych urządzeń

PT Reproduzir noutros dispositivos

RO Redarea de pe alte dispozitive

SK Prehrávanie iných zariadení

SV Spela upp från andra enheter

TR Diğer cihazlardan içerik oynatma

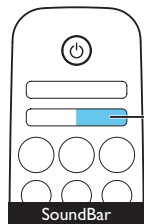

3

AUDIO IN

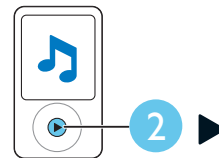

2

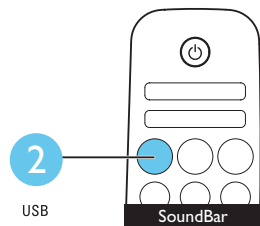
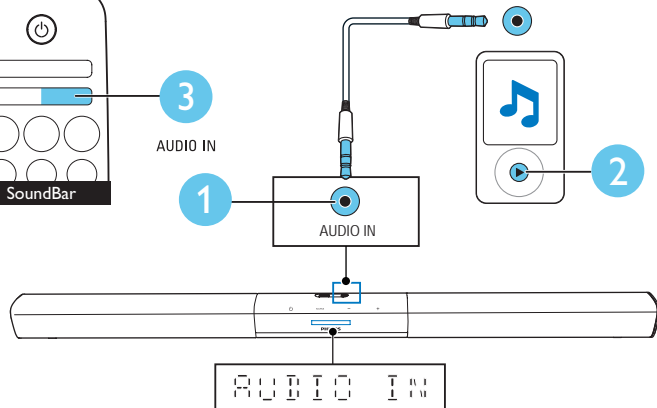

2

USB

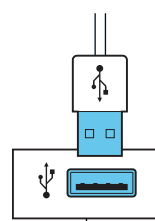

1

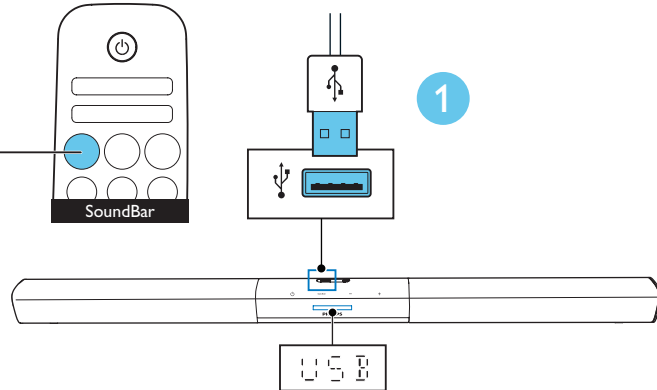

7

EN Play audio through Bluetooth

CS Přehrávání zvuku prostřednictvím rozhraní Bluetooth

DA Afspil lyd via Bluetooth

DE Audiowiedergabe über Bluetooth

EL Αναπαραγωγή ήχου μέσω Bluetooth

ES Reproducción de audio a través de Bluetooth

FI Äänen toistaminen Bluetoothin kautta

FR Lecture de musique via Bluetooth

HU Játsszon le műsort más készülékről

IT Riproduzione di file audio tramite Bluetooth

NL Audio afspelen via Bluetooth

NO Spille av lyd via Bluetooth

PL Odtwarzanie dźwięku przez połączenie Bluetooth

PT Reproduzir noutros dispositivos

RO Redați sunetul prin Bluetooth

SK Prehrávanie zvukového obsahu cez rozhranie Bluetooth

SV Spela upp ljud via Bluetooth

TR Bluetooth yoluyla müzik çalma

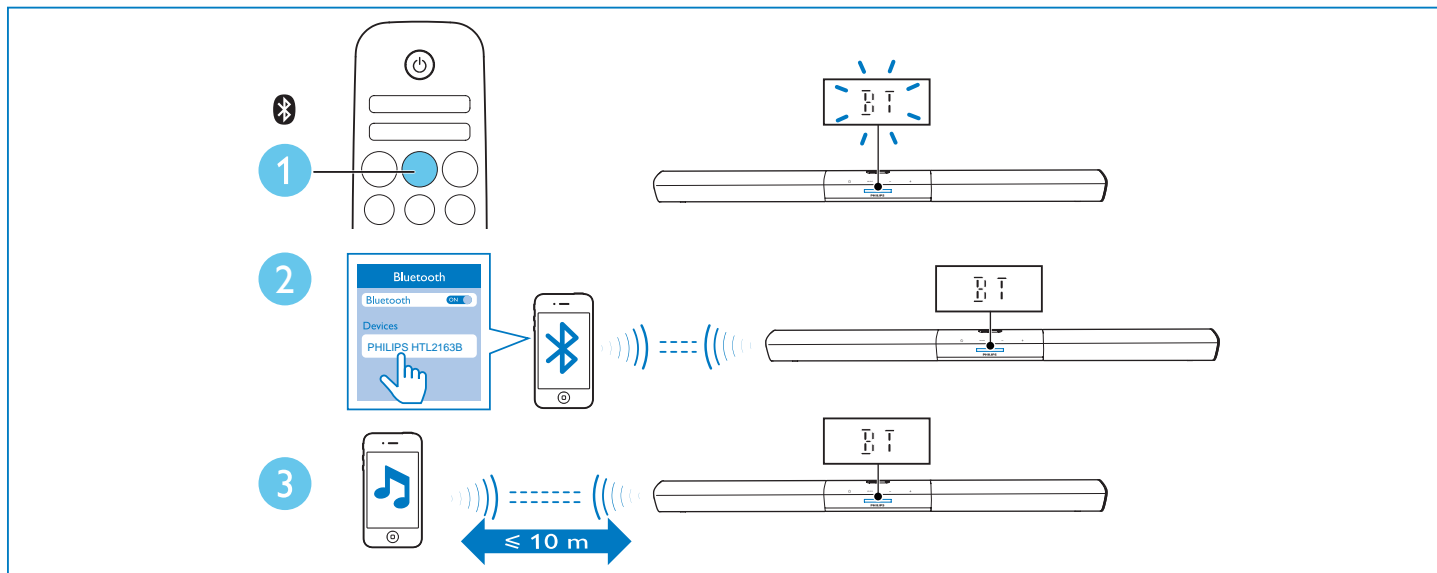

EN Organize the cables

CS Uspořádnání kabelů

DA Organisere kablerne

DE Organisieren der Kabel

EL Οργάνωση των καλωδίων

ES Organización de los cables

FI Järjestä kaapelit

FR Organisation des câbles

HU A kábelek elrendezése

IT Gestione dei cavi

NL De kabels ordenen

NO Organisere kablene

PL Porządkowanie przewodów

PT Organizar os cabos

RO Organizați cablurile

SK Usporiadajte káble

SV Organisera kablarna

TR Kablolan düzenleyin

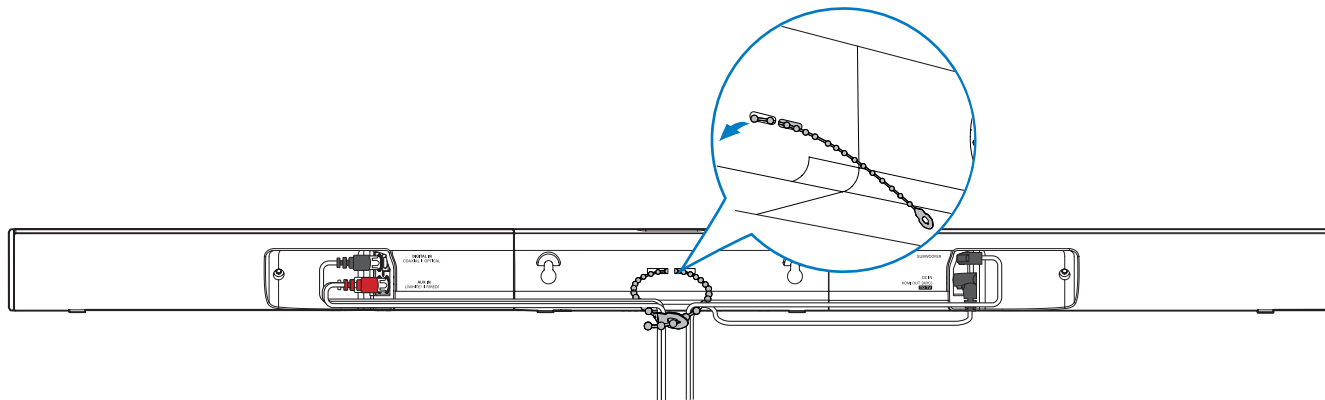



EN For more information about using this product, visit www.philips.com/support

CS Více informací o použití výrobku naleznete na stránkách www.philips.com/support

DA Du kan finde yderligere oplysninger om brugen af dette produkt på www.philips.com/support

DE Weitere Informationen zur Verwendung dieses Produkts finden Sie unter www.philips.com/support

EL Για περισσότερες πληροφορίες σχετικά με τη χρήση αυτού του προϊόντος, επισκεφθείτε το www.philips.com/support

ES Para obtener más información sobre este producto, visite www.philips.com/support

FI Lue lisätietoja tuotteen käytöstä osoitteessa www.philips.com/support

FR Pour obtenir davantage d'informations sur l'utilisation de ce produit, rendez-vous sur www.philips.com/support

HU A termék használatával kapcsolatos további információkkal kapcsolatban tekintse meg a www.philips.com/support weboldalt

IT Per ulteriori informazioni sull'uso di questo prodotto, visitare il sito www.philips.com/support

NL Ga voor meer informatie over dit product naar www.philips.com/support

NO Hvis du vil ha mer informasjon om bruk av dette produktet, kan du gå til www.philips.com/support

PL Więcej informacji na temat korzystania z tego produktu można znaleźć na stronie www.philips.com/support

PT Para mais informações sobre a utilização deste produto, visite www.philips.com/support

RO Pentru informații suplimentare despre utilizarea acestui produs, vizitați www.philips.com/support

SK Ďalšie informácie o používaní tohto výrobku nájdete na stránke www.philips.com/support

SV Mer information om att använda den här produkten finns på www.philips.com/support

TR Bu ürünün kullanımı hakkında daha fazla bilgi için www.philips.com/support adresini ziyaret edin



www.philips.com/support



Manufactured under license from Dolby Laboratories. Dolby and the double-D symbol are trademarks of Dolby Laboratories.



The terms HDMI and HDMI High-Definition Multimedia Interface, and the HDMI Logo are trademarks or registered trademarks of HDMI Licensing LLC in the United States and other countries.



The Bluetooth® word mark and logos are registered trademarks owned by Bluetooth SIG, Inc. and any use of such marks by Gibson is under license. Other trademarks and trade names are those of their respective owners.



Specifications are subject to change without notice
2015 © Gibson Innovations Limited. All rights reserved.
This product has been manufactured by, and is sold under the responsibility of Gibson Innovations Ltd., and
Gibson Innovations Ltd. is the warrantor in relation to this product. Philips and the Philips Shield Emblem are
registered trademarks of Koninklijke Philips N.V. and are used under license from Koninklijke Philips N.V.

HTL2163B_12_QSG_V4.0

