

English

- Read **Safety and Reference**.
- For the power supply and power consumption, refer to the label attached to the product.

Русский

- Прочтите **Руководство по технике безопасности**.
- Требования параметров электропитания указаны на информационном лейбле на задней крышке изделия.

Українська

- Прочитайте **"Правила безпеки та довідкова інформація"**.
- Відомості щодо подачі живлення і споживання електроенергії дивіться на наліпці на виробі.

Қазақша

- **Қауіпсіздік нұсқаулығын** оқыңыз.
- Электр энергия және тұтыну параметр мәліметтерін өнімдегі жапсырмадан қараңыз.

O'zbekcha

- **Xavfsizlik bo'yicha ko'rsatmalar va havolalar** o'qib chiqing.
- Quvvat ta'minoti va quvvat iste'moli uchun mahsulotga yopishtirilgan yorliqqa qarang.

Монгол

- **Аюулгүй ажиллагааны зааварчилгаа** унш.
- Тэжээл, цахилгаан зарцуулалтын талаарх мэдээллийг бүтээгдэхүүний шошгоос харна уу.





OPTICAL DIGITAL AUDIO OUT

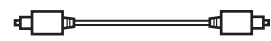

LAN

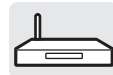

USB IN



HDMI IN



COMPONENT IN

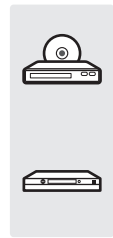
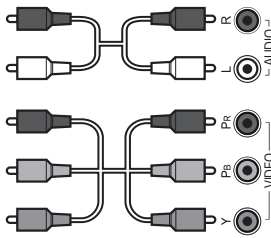

AV IN

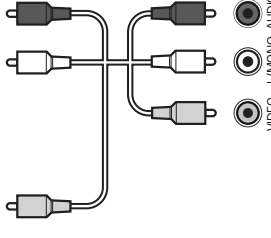

Satellite IN



ANTENNA / CABLE IN

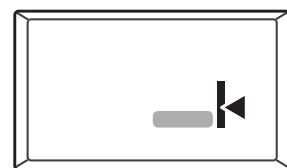

PCMCIA CARD SLOT

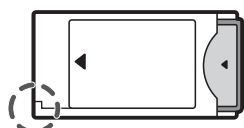

HDMI IN



HDMI IN/ARC



USB IN

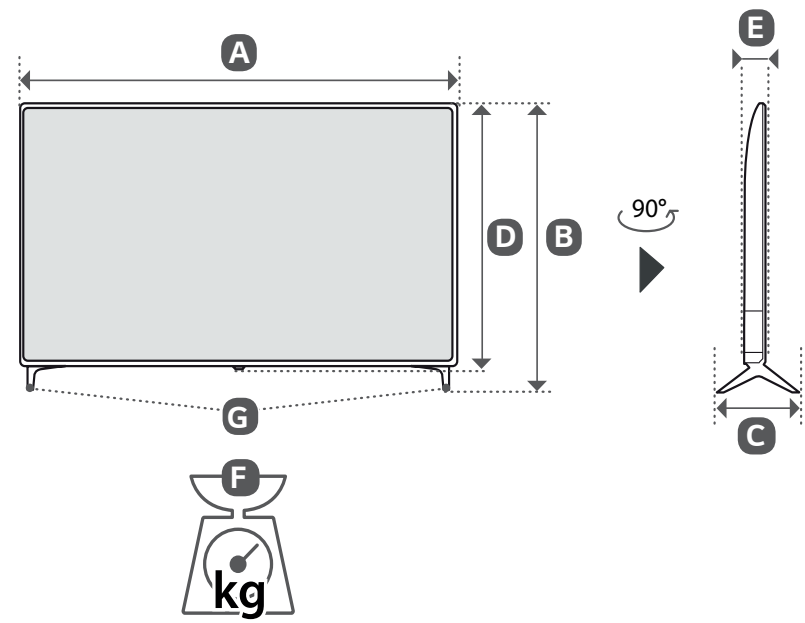
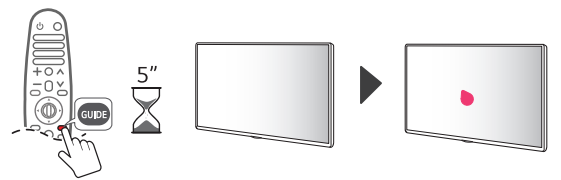
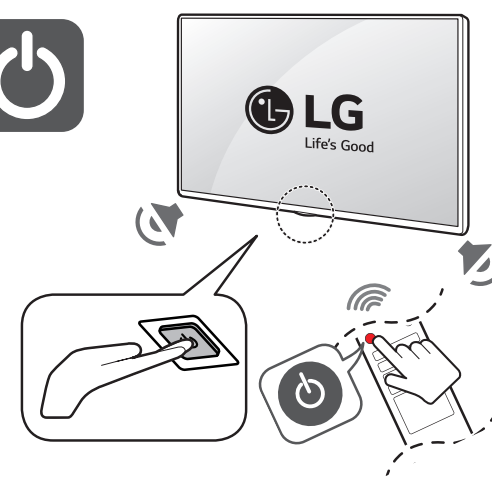
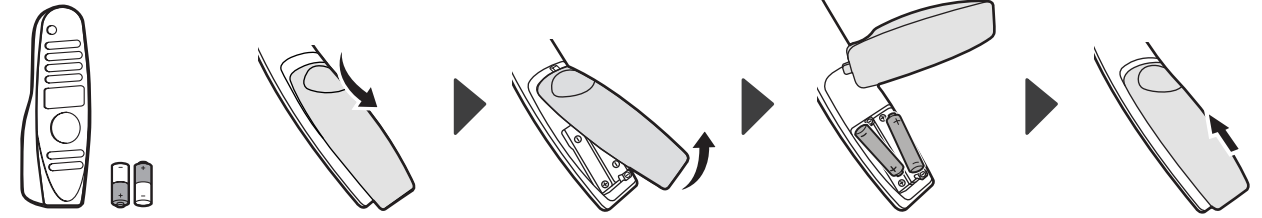
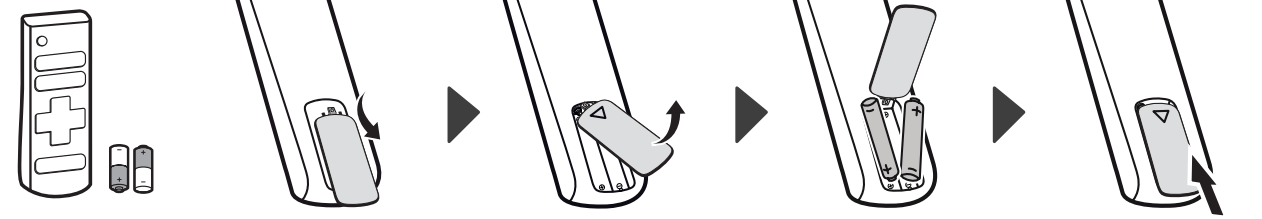

	A	B	C	D	E	F	F-G
	(mm)			(kg)			
49UM7300PLB 49UM7390PLC	1110	709	231	650	81.1	11.3	11.1
50UM7300PLB	1130	722	231	663	86.3	11.5	11.3
55UM7300PLB	1244	786	231	726	87.1	14.5	14.3
65UM7300PLB	1463	914	269	850	87.8	21.6	21.3
Power requirement				AC 100-240 V - 50 / 60 Hz			