

**SAMSUNG**

# USER MANUAL

SM-R930  
SM-R935F  
SM-R940  
SM-R945F  
SM-R950  
SM-R955F  
SM-R960  
SM-R965F

# Table of Contents

## Getting started

### 6 About the Galaxy Watch6 / Galaxy Watch6 Classic

### 7 Device layout and functions

7 Watch

13 Wireless charger

### 13 Charging the battery

13 Wireless charging

14 Charging the battery using  
Wireless power sharing

15 Battery charging tips and  
precautions

17 Using power saving mode

### 17 Wearing the Watch

17 Attaching and removing the band

19 Putting on the Watch

19 Band tips and precautions

20 How to wear the Watch for  
accurate measurements

### 22 Turning the Watch on and off

### 23 Connecting the Watch to a phone

23 Installing the Galaxy Wearable  
app

23 Connecting the Watch to a phone  
through Bluetooth

25 Remote connection

### 25 Adding the accounts to your Watch

### 26 Controlling the screen

26 Bezel

27 Touch screen

28 Screen composition

29 Turning the screen on and off

30 Switching the screen

30 Apps screen

32 Lock screen

### 32 Watch

32 Watch screen

32 Changing the watch face

34 Turning on the Always On Display  
feature

34 Turning on watch only mode

### 35 Notifications

35 Notification panel

36 Checking incoming notifications

36 Selecting apps for receiving  
notifications

### 37 Quick panel

### 40 Entering text

40 Keyboard layout

41 Additional keyboard functions

## **Apps and features**

### **42 Installing and managing apps**

- 42 Play Store
- 42 Managing apps

### **43 Messages**

### **45 Phone**

- 45 Introduction
- 45 Making calls
- 47 Options during calls
- 47 Receiving calls

### **48 Contacts**

### **49 Samsung Wallet**

### **50 Samsung Pay**

- 50 Introduction
- 50 Setting up Samsung Pay
- 50 Making payments

### **51 Samsung Health**

- 51 Introduction
- 52 Daily activity
- 53 Steps
- 54 Exercise
- 65 Food
- 66 Sleep
- 69 Heart rate
- 71 Stress
- 73 Body composition
- 76 Cycle tracking
- 77 Water
- 78 Blood oxygen
- 80 Together
- 81 Settings

### **82 Samsung Health Monitor**

- 82 Introduction
- 82 Precautions for measuring blood pressure and ECG
- 86 Starting to measure the blood pressure
- 88 Starting to measure the ECG

### **90 GPS**

### **91 Music**

- 91 Introduction
- 91 Using Music
- 91 Managing audio files saved on your Watch

### **92 Media Controller**

- 92 Introduction
- 92 Controlling the music player
- 93 Controlling the video player

### **94 Reminder**

### **95 Calendar**

### **95 Bixby**

### **96 Weather**

### **96 Alarm**

### **97 World Clock**

### **97 Timer**

### **98 Stopwatch**

### **98 Gallery**

- 98 Introduction
- 98 Transferring pictures to your Watch
- 99 Using Gallery
- 99 Viewing images
- 100 Customising a watch face
- 100 Deleting images

**100 Find My Phone**

**101 Find My Watch**

**102 Sending an SOS**

- 102 Introduction
- 102 Entering medical information
- 102 Sharing your emergency
- 103 Requesting an SOS
- 104 Requesting an SOS when you are hurt from a fall
- 105 Stop sharing the location information

**106 Voice Recorder**

**107 Calculator**

**107 Compass**

**107 Buds Controller**

**108 Camera Controller**

**108 Samsung Global Goals**

**109 SmartThings**

**109 Google apps**

**110 Settings**

- 110 Introduction
- 110 Samsung account
- 110 Connections
- 114 Modes
- 115 Notifications
- 115 Sounds and vibration
- 116 Display
- 116 Health
- 117 Security and privacy
- 117 Location
- 118 Safety and emergency
- 118 Accounts and backup
- 119 Google
- 119 Advanced features

120 Battery and device care

121 Apps

121 General

122 Accessibility

122 Software update

123 About watch

## Galaxy Wearable app

**124 Introduction**

**125 Watch faces**

**126 Apps screen**

**127 Tiles**

**127 Quick panel**

**128 Watch settings**

- 128 Introduction
- 128 Samsung account
- 128 Modes
- 128 Notifications
- 129 Sounds and vibration
- 129 Display
- 129 Health
- 129 Samsung Wallet / Samsung Pay
- 129 Safety and emergency
- 130 Accounts and backup
- 130 Advanced features
- 131 Battery and device care
- 131 Apps
- 131 Manage content
- 132 Mobile plans (SM-R935F, SM-R945F, SM-R955F, SM-R965F)
- 132 General
- 132 Accessibility
- 133 Watch software update
- 133 About watch

**133 Find My Watch**

**133 Store**

## **Usage notices**

**134 Precautions for using the device**

**136 Notes on package contents and accessories**

**137 Maintaining the device's water and dust resistance**

**139 Precautions for overheating**

**139 Cleaning and managing the Watch**

**140 Use caution if you are allergic to any materials on the Watch**

## **Appendix**

**141 Troubleshooting**

**145 Removing the battery**

# Getting started

## About the Galaxy Watch6 / Galaxy Watch6 Classic

The Galaxy Watch6 / Galaxy Watch6 Classic (hereafter, Watch) is a smartwatch that can analyse your exercise pattern, manage your health, and provide you with a variety of convenient apps for making phone calls and playing music. You can browse the various features by using the bezel or launch a feature by tapping the screen and also change the watch face to match your taste.

You can use your Watch after connecting it to your phone.

# Device layout and functions

## Watch

### ► Galaxy Watch6:

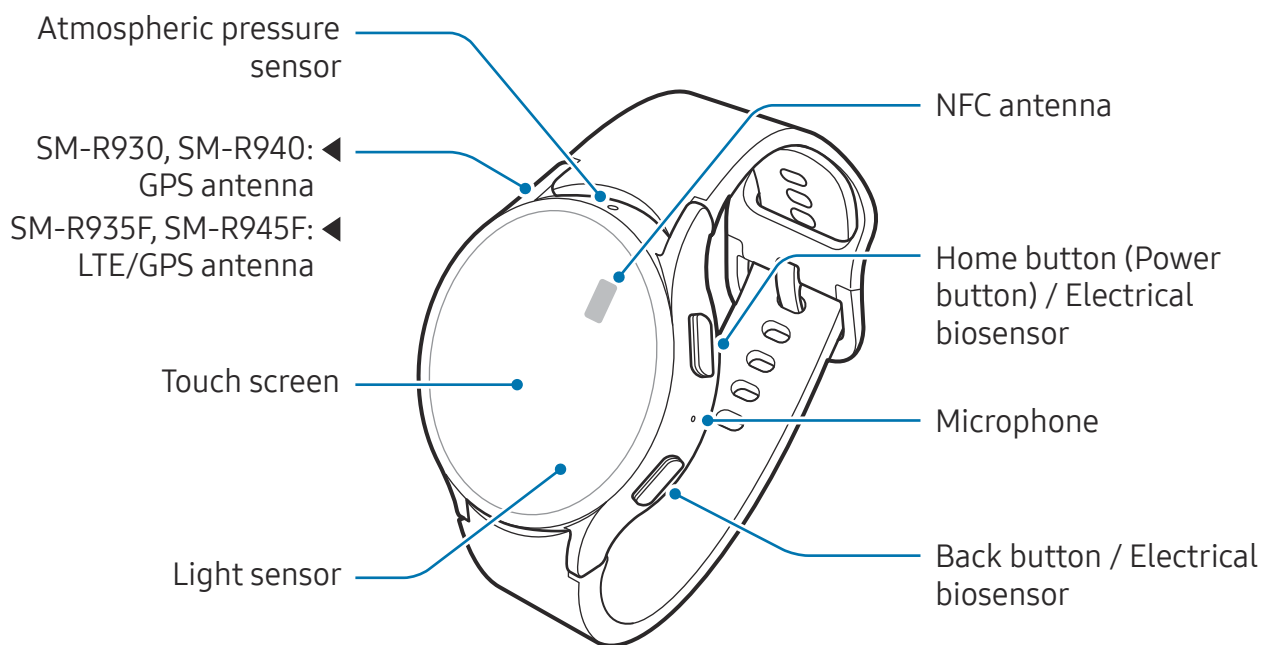

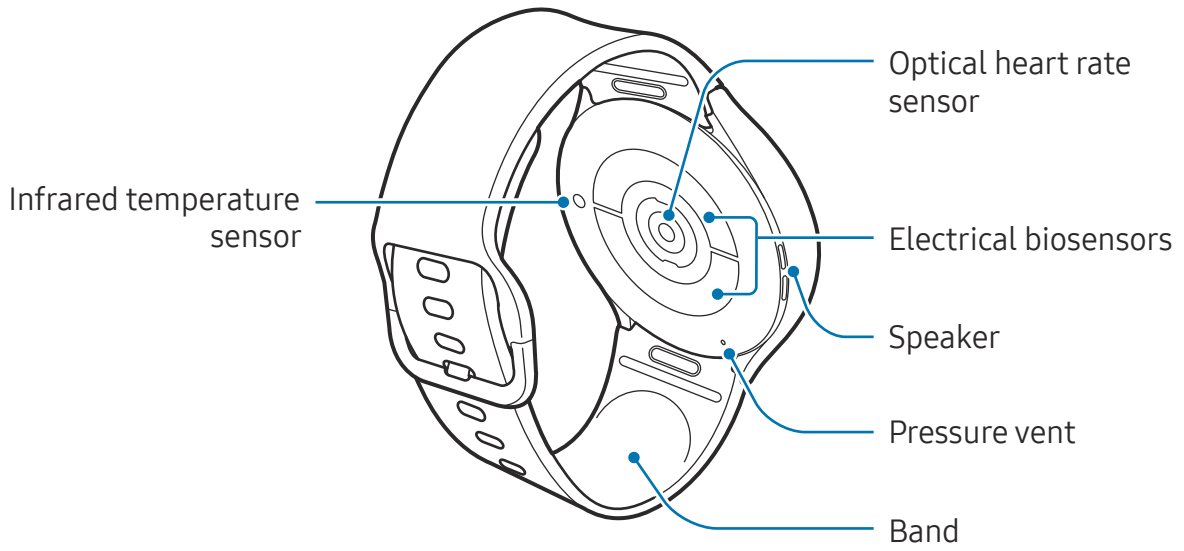
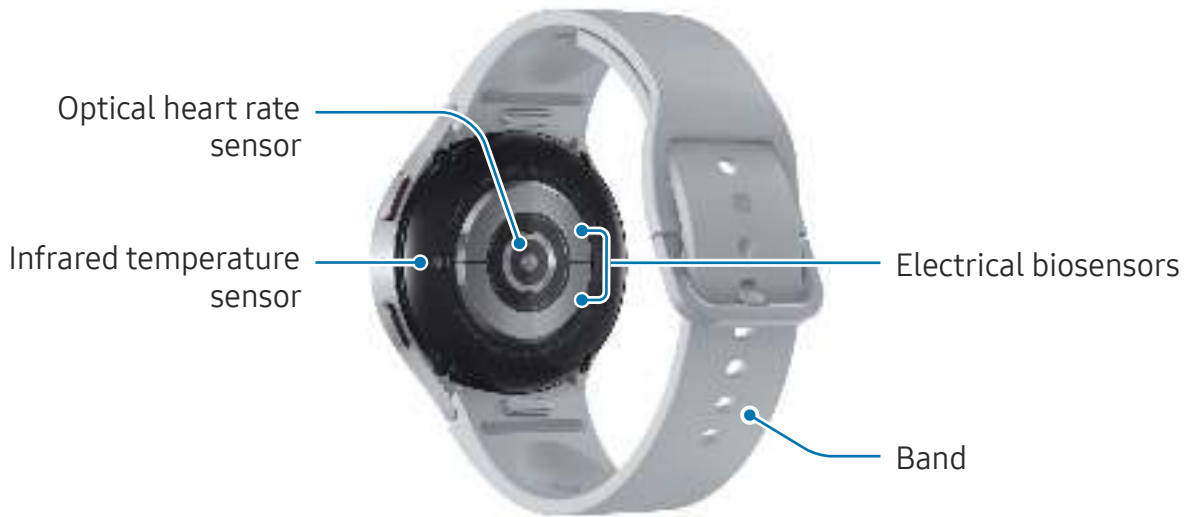



► Galaxy Watch6 Classic:

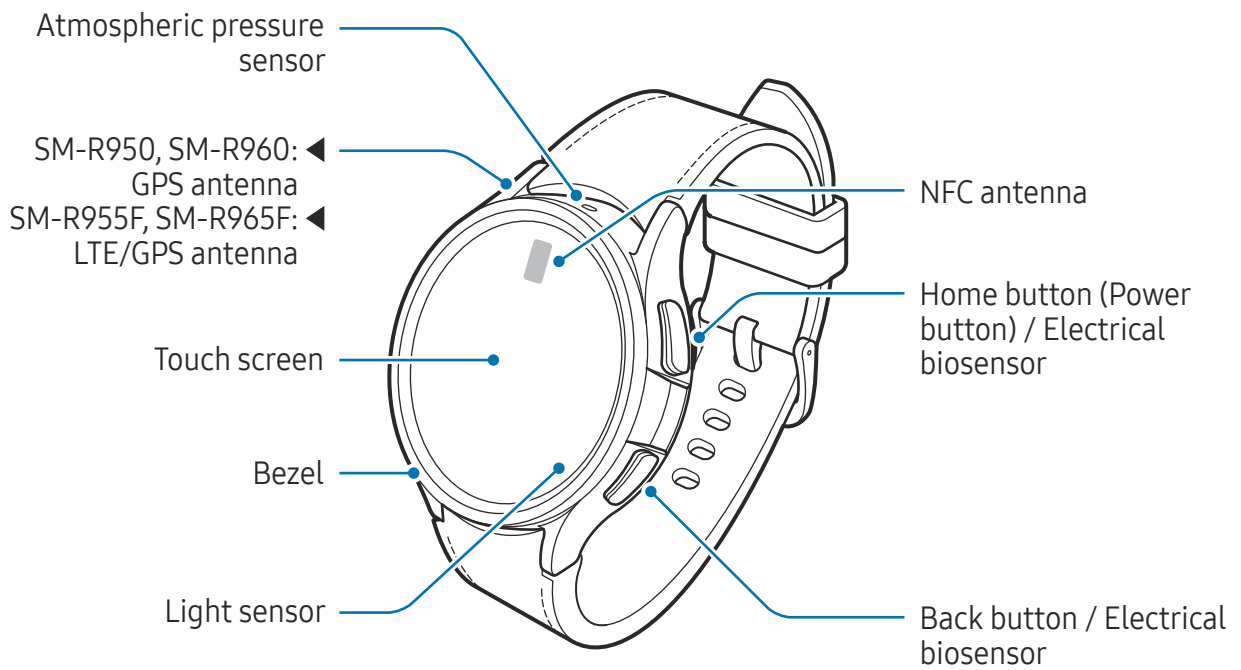

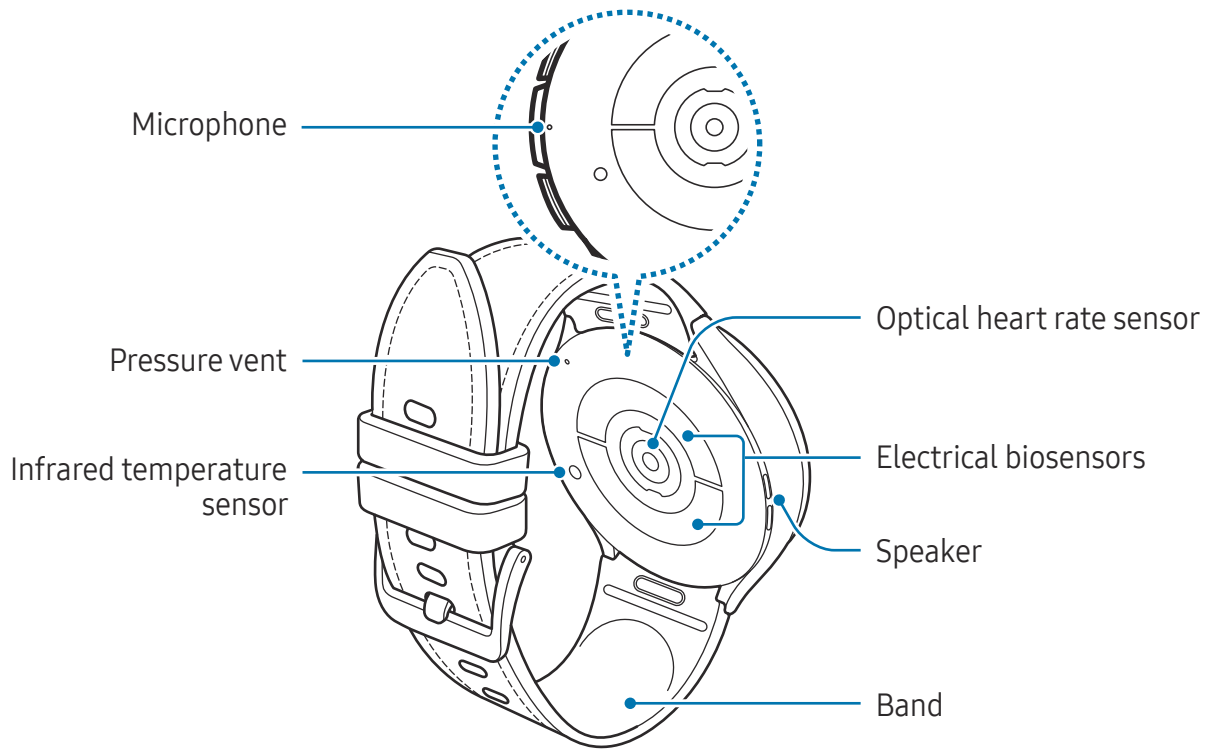

- ⚠ • Use the device in a place without magnetic interference for the device to operate normally.
- Your device and some accessories (sold separately) contain magnets. Keep it away from credit cards, implanted medical devices, and other devices that may be affected by magnets. In the case of medical devices, keep your device more than 15 cm apart. Stop using your device if you suspect any interference with your medical device and consult your physician or your medical device manufacturer.
- If you have a medical implant in your heart, do not place your device in a pocket close to your implanted device, such as your chest or inner jacket pocket.
- Keep a safe distance between objects that are affected by magnets, and your device and some accessories (sold separately) that contain magnets. Objects such as credit cards, passbooks, access cards, boarding passes, or parking passes may be damaged or disabled by the magnets in the device.
- ⚠ • When using the speakers, such as when playing media files, do not place the Watch close to your ears.
- Ensure that the band is kept clean. Contact with contaminants, such as dust and dye, can cause stains on the band that may not be fully removed.
- Do not insert sharp objects into the Watch's external holes. The inner components may be damaged along with the water-resistance feature.
- If you use the Watch with its glass body broken, there may be a risk of injury. Use the Watch only after it has been repaired at a Samsung Service Centre or an authorised service centre.
- If dust or foreign materials enter the microphone or speaker, the Watch's sound may become quiet or certain features may not work. If you attempt to remove the dust or foreign materials with a sharp object, the Watch may be damaged and its appearance may be affected.



- Connectivity problems and battery drain may occur in the following situations:
  - If you attach metallic stickers on the antenna area of the Watch
  - If you use a metallic band
  - If you cover the Watch's antenna area with your hands or other objects while using certain features, such as calls or the mobile data connection
- If the pressure vent is covered by an accessory, such as a sticker, unwanted noises may occur during calls or media playback.
- Do not cover the light sensor area with accessories, such as stickers or a cover. Doing so may cause the sensor to malfunction.
- Make sure the Watch's microphone is not obstructed when you are speaking into it.
- The pressure vent ensures that Watch's inner parts and sensors work correctly when you use the Watch in environment where the atmospheric pressure changes.
- The images in this manual are of a Galaxy Watch6 Classic.

## Buttons

Button	Function
Home button	<ul style="list-style-type: none"> <li>• When the Watch is off, press and hold to turn it on.</li> <li>• When the screen is off, press to turn on the screen.</li> <li>• Press and hold to start a conversation with Bixby. Refer to <a href="#">Using Bixby</a> for more information.</li> <li>• Press twice or press and hold to open the app or feature you set. (ⓘ (Settings) → <b>Advanced features</b> → <b>Customise buttons</b>)</li> <li>• Press to open the Watch screen when you are on any other screen.</li> </ul>
Back button	<ul style="list-style-type: none"> <li>• When the screen is off, press to turn on the screen.</li> <li>• Press to launch the feature you set. (ⓘ (Settings) → <b>Advanced features</b> → <b>Customise buttons</b>)</li> </ul>
Home button + Back button	<ul style="list-style-type: none"> <li>• Press simultaneously to capture a screenshot.</li> <li>• Press and hold simultaneously to turn off the Watch.</li> </ul>

## Wireless charger

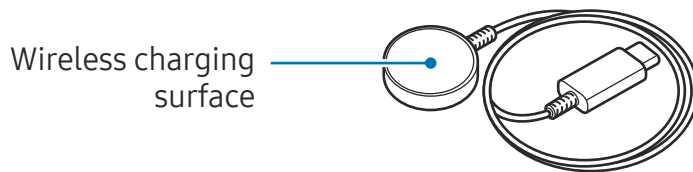

- ⚠ Do not expose the wireless charger to water because the wireless charger does not have same water-resistance certification as your Watch.

## Charging the battery

Charge the battery before using your Watch for the first time or when it has been unused for extended periods.

## Wireless charging

- 1 Connect the wireless charger to the USB power adapter.
- 2 Place the Watch on the wireless charger aligning the centre of your Watch's backside with the centre of the wireless charger. Wireless charging may not work smoothly depending on the type of accessory or cover. For stable wireless charging, it is recommended to separate the cover or accessory from the Watch.

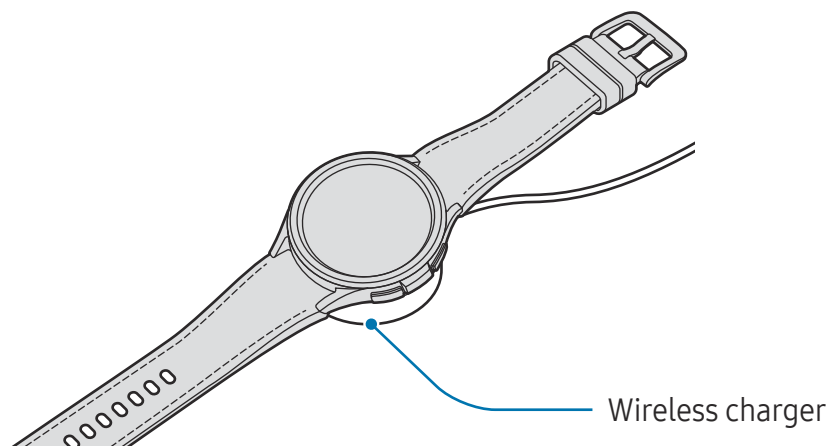

- 3 After fully charging, disconnect the Watch from the wireless charger.

## Checking the charging status

You can check the charging status on the screen during wireless charging. If the charging status does not appear on the screen, on the Apps screen, tap  (**Settings**) → **Display** and tap the **Show charging info** switch to turn it on.

If you charge the Watch when it is turned off, press any button to check the charging status on the screen.



## Charging the battery using Wireless power sharing

You can charge your Watch with the battery of the device that works as a wireless charging pad. You can still charge your Watch even while charging the device that works as a wireless charging pad. Depending on the type of accessories or cover being used, the Wireless power sharing feature may not work properly. It is recommended to remove any cover being used from the device that works as a wireless charging pad and your Watch before using this feature.

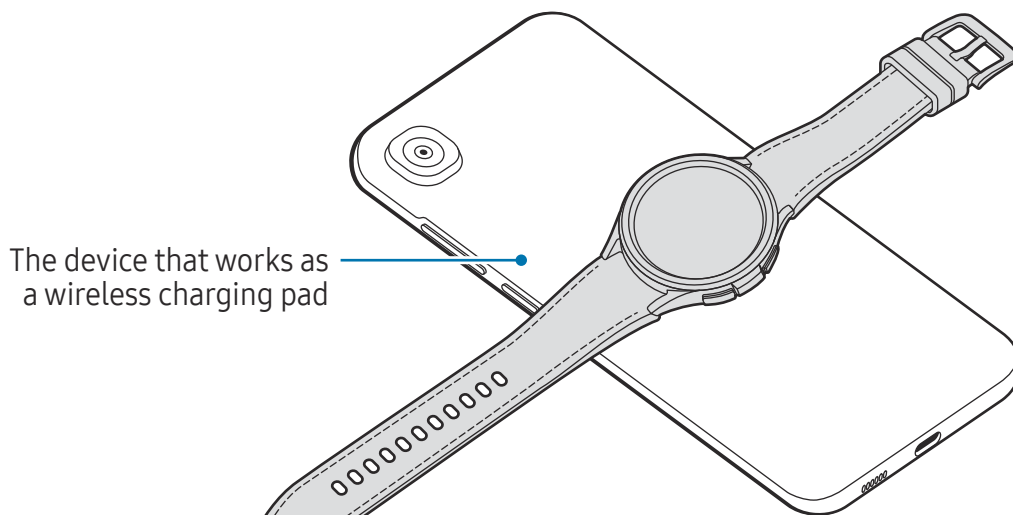

- 1 Turn on the Wireless power sharing feature on the device that works as a wireless charging pad and place the centre of the Watch's back on the backside of the device that works as a wireless charging pad.



2 After fully charging, disconnect the Watch from the device that works as a wireless charging pad.

-  Do not use the headphones or Bluetooth headset while sharing power. Doing so may affect nearby devices.
- 
  - The location of the wireless charging coil may vary by device model. Adjust the device or Watch to connect with each other properly.
  - Some features that work while wearing the Watch are not available while sharing power.
  - To charge properly, do not move or use the device that works as a wireless charging pad or Watch while charging.
  - The power charged to your Watch may be less than the amount shared to it by the device that works as a wireless charging pad.
  - If you charge the Watch while charging the device that works as a wireless charging pad, the charging speed may decrease or the Watch may not charge properly, depending on the charger type.
  - The charging speed or efficiency may vary depending on the condition of the device that works as a wireless charging pad or the surrounding environment.
  - If the remaining battery power of the device that works as a wireless charging pad drops below a certain level, power sharing will stop.

## Battery charging tips and precautions

-  Use only Samsung-approved charger and cable specifically designed for your Watch. Incompatible charger and cable can cause serious injuries or damage to your device.
- 
  - Connecting the charger improperly may cause serious damage to the device. Any damage caused by misuse is not covered by the warranty.
  - Use only wireless charger supplied with the Watch. The Watch cannot be charged properly with a third-party wireless charger.
  - If you charge the Watch while the wireless charger is wet, the device may be damaged. Thoroughly dry the wireless charger before charging the Watch.





- To save energy, unplug the charger when not in use. The charger does not have a power switch, so you must unplug the charger from the electric socket when not in use to avoid wasting power. The charger should remain close to the electric socket and easily accessible while charging.
- The Watch has a built-in wireless charging coil. You can charge the battery by using a wireless charging pad. The wireless charging pad is sold separately. For more information about available wireless charging pads, refer to the Samsung website.
- When using a charger, it is recommended to use an approved charger that guarantees the charging performance.
- If there are obstructions between the Watch and the wireless charger, it may not charge properly. Check if there is any sweat, liquid, or dust on them before charging.
- If the battery is completely discharged, the Watch cannot be turned on immediately when the wireless charger is connected. Allow a depleted battery to charge for a few minutes before turning it on.
- If you use multiple apps at once, network apps, or apps that need a connection to another device, the battery will drain quickly. To avoid losing power during a data transfer, always use these apps after fully charging the battery.
- When connecting the wireless charger to another power source, such as a computer or multi-charging hub, the Watch may not charge properly or it may charge more slowly because of a lower electric current.
- The Watch can be used while it is charging, but it may take longer to fully charge the battery.
- If the Watch's power supply is unstable while being used and charged at the same time, the touch screen may not be responsive. If this happens, disconnect the Watch from the wireless charger.
- While charging, the Watch may heat up. This is normal and should not affect the Watch's lifespan or performance. Before wearing the Watch, allow it to cool down for a while before using it. If the battery gets hotter than usual, the charger may stop charging.
- If the Watch is not charging properly, take the Watch and the wireless charger to a Samsung Service Centre or an authorised service centre.
- Avoid using a bent or damaged wireless charger cable. If the wireless charger cable is damaged, stop using it.



## Using power saving mode

Turn on power saving mode to extend the battery's usage time.

Open the quick panel by dragging downwards from the top edge of the screen and tap  to turn the feature on. Alternatively, on the Apps screen, tap  (**Settings**) → **Battery and device care** → **Battery** and tap the **Power saving** switch to turn it on.



Power saving mode will be turned on and some features can be restricted.

-  If the battery power drops below a certain level, the power saving screen will appear. Tap **Turn on** to turn power saving mode on. In this case, power saving mode will be turned off automatically when your Watch's battery is charged more than 15%. However, if you turn on power saving mode from the Settings menu or quick panel, power saving mode will not be turned off automatically, even if your Watch's battery is charged to more than 15%.

## Wearing the Watch

### Attaching and removing the band

Attach the band before using your Watch. You can detach the band from the Watch and replace it with a new one.

-  Be careful not to hurt your fingernail when attaching or replacing bands.
- 
  - The supplied band may vary depending on the region or model.
  - The supplied band's size may vary depending on the model. Use the proper band which fits your model's size.

- 1 Attach the band to your Watch while pressing the band's button firmly.

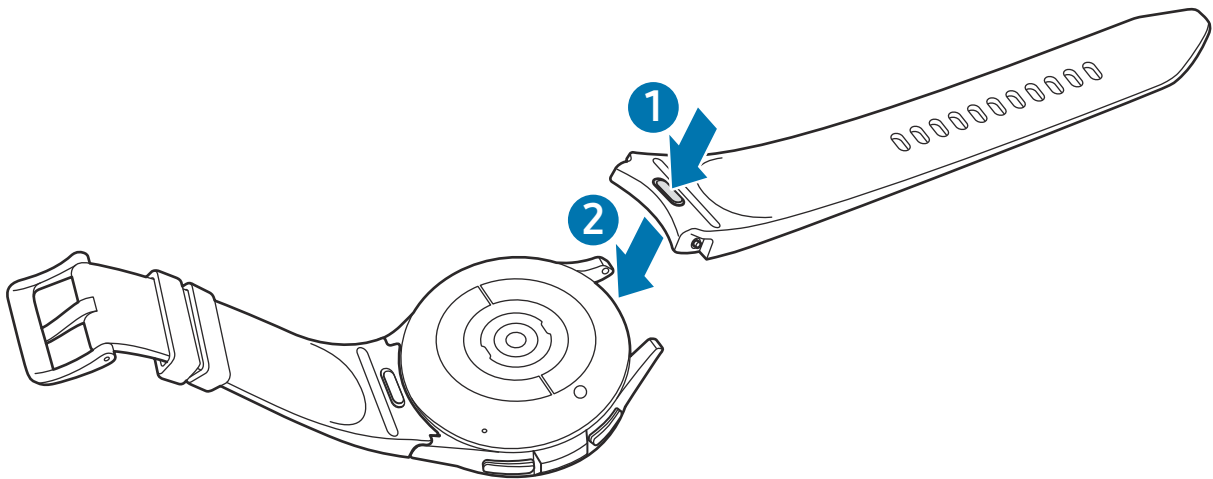

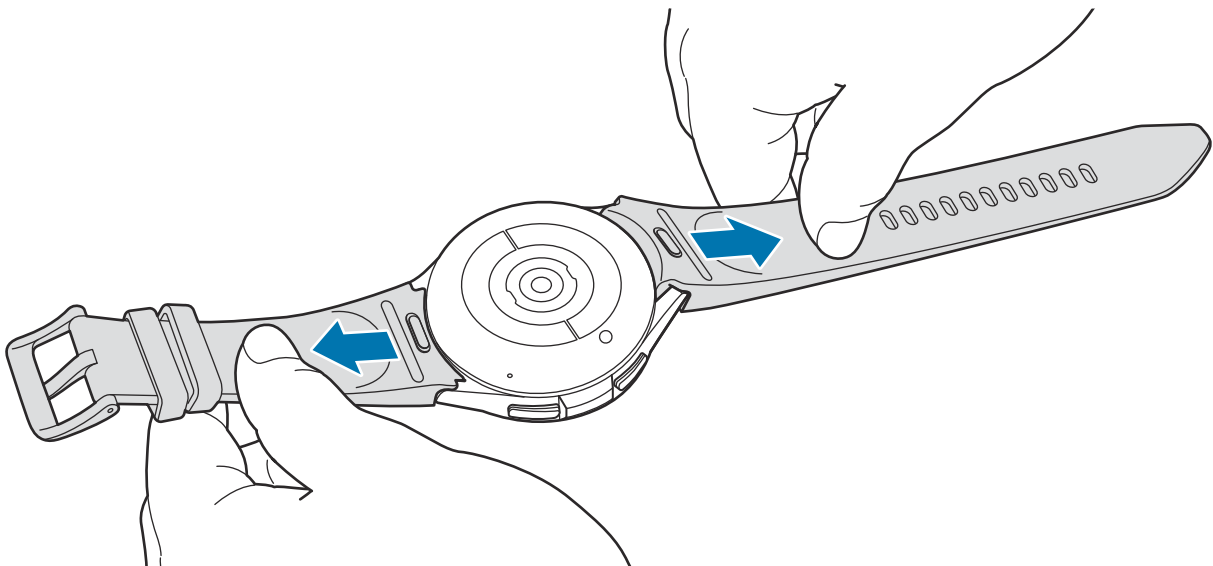

- 2 Gently pull on both sides of the band to make sure it is tightly connected and not detached from your Watch.



Remove the band while pressing the band's button.

## Putting on the Watch

Open the buckle and place your Watch around your wrist. Fit the band to your wrist, insert the pin into an adjustment hole, and then secure the buckle to close it. If the band is too tight, use the next hole.

-  Do not bend the band excessively. Doing so may damage the Watch.
- 
  - To measure your physical condition accurately, wear the Watch firmly around your lower arm above the wrist. Refer to [How to wear the Watch for accurate measurements](#) for more information.
  - When certain materials come into contact with the back of the Watch, your Watch may recognise that you are wearing it on your wrist depending on the type of material.
  - If the sensors on the back of your Watch do not come into contact with your wrist for more than 10 minutes, your Watch may recognise that you are not wearing it on your wrist.

## Band tips and precautions

- For accurate measurement, you have to wear the Watch so that it fits your wrist. After measuring, loosen the band to allow air to reach your skin. It is recommended to wear the Watch so that it is not too loose or tight, and that it feels comfortable in normal circumstances.
- When you wear the Watch for a long time or do a high-intensity exercise while wearing it, skin irritation may occur because of certain factors, such as friction, pressure, or moisture. If you have been wearing your Watch for a long time, remove it from your wrist for a while to keep your skin healthy and allow your wrist to rest.
- Skin irritation may occur because of an allergy, environment factors, other factors, or when your skin is exposed to soap or sweat for long periods. In this case, stop using your Watch immediately and wait 2 or 3 days for the symptoms to ease. If the symptoms persist or worsen, call your doctor.
- Make sure your skin is dry before wearing your Watch. If you wear a wet Watch for a long time, your skin may be affected.
- If you use your Watch in the water, remove foreign materials from your skin and Watch and dry them thoroughly to prevent the skin irritation.
- Do not use any accessories except the Watch in the water.

## How to wear the Watch for accurate measurements

For accurate measurements, wear the Watch firmly around your lower arm above the wrist while leaving a finger's worth of space as shown in the figure.

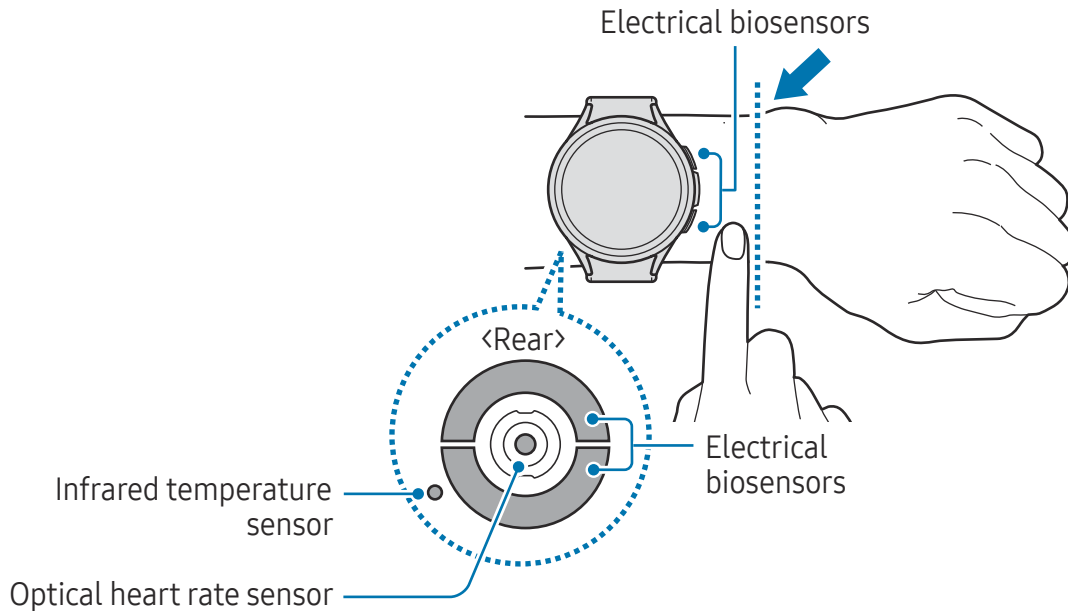

- ❗ If you fasten the Watch too tightly, skin irritation may occur, and if you fasten it too loosely, friction may occur.
- Do not look directly at the optical heart rate sensor's lights. Make sure children do not look directly at the lights. Doing so may impair your vision.
- If the Watch becomes hot to the touch, remove it until it cools. Exposing your skin to the Watch's hot surface for a long time may cause low-temperature burns.
- Remove all water from your Watch and the band before measuring your body composition and ECG.
- If any water, dust, or stains are on the infrared temperature sensor, the measurements may be inaccurate.
- Clean the infrared temperature sensor with a soft cloth or cotton bud.



- Use the HR feature only for measuring your heart rate. The accuracy of the optical heart rate sensor may be diminished depending on the surroundings, measurement conditions, and user's physiological state.
- As cold ambient temperatures may affect your measurement, keep yourself warm when checking your heart rate during winter or cold weather.
- Smoking or consuming alcohol before taking measurements may cause your heart rate to be different from your normal heart rate.
- Do not move, talk, yawn, or breathe deeply while taking heart rate measurements. Doing so may cause your heart rate to be recorded inaccurately.
- If your heart rate is extremely high or low, the measurement may not be accurate.
- If measuring children's heart rates, the measurement may not be accurate.
- Users with thin wrists may receive inaccurate heart rate measurements when the Watch is loose, causing the light to be reflected unevenly. In this case, wear the Watch on your inner arm.
- If heart rate measurement is not working properly, adjust the position of the Watch's optical heart rate sensor to the right, left, up, or down on your wrist, or wear the Watch on your inner arm so that the sensor is in contact with your skin.
- If the optical heart rate sensor and the electrical biosensors are dirty, wipe the sensors and try again. If foreign materials prevent the light from reflecting evenly, the measurement may not be accurate.
- The optical heart rate sensor may be affected by tattoos, marks, and hair on the wrist you wear your Watch on. These may cause your Watch not to recognise that you are wearing it, and the Watch's features may not work properly. Therefore, wear your Watch on a wrist that does not interfere with the Watch's features.
- The measurement features may not work properly because of certain factors, such as the light from the optical heart rate sensor being blocked, depending on your skin brightness, blood flow under your skin, and the cleanliness of the sensor area.
- For accurate measurements, use the Ridge sport band. The Ridge sport band may be sold separately depending on the model.

## Turning the Watch on and off

- Follow all posted warnings and directions from authorised personnel in areas where the use of wireless devices is restricted, such as aeroplanes and hospitals.

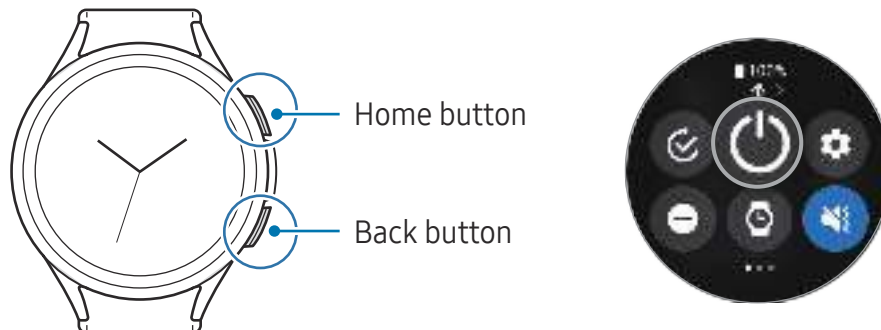



### Turning the Watch on

Press and hold the Home button for a few seconds to turn on the Watch.

When you turn on the Watch for the first time or reset it, on-screen instructions will appear to open the Galaxy Wearable app on your phone. Refer to [Connecting the Watch to a phone](#) for more information.

### Turning the Watch off

- 1 Press and hold the Home button and the Back button simultaneously. Alternatively, open the quick panel by dragging downwards from the top edge of the screen and tap .
- 2 Tap .



- You can set the Watch to turn off when you press and hold the Home button. On the Apps screen, tap  (**Settings**) → **Advanced features** → **Customise buttons**, tap **Press and hold** under **Home button**, and then select **Power off menu**.

### Forcing restart

If your Watch is frozen and unresponsive, press and hold the Home button and the Back button simultaneously for more than 7 seconds to restart it.

## Emergency call

You can make an emergency call.

- 1 Press and hold the Home button and the Back button simultaneously. Alternatively, open the quick panel by dragging downwards from the top edge of the screen and tap .
  - 2 Tap **Emergency call**.
-  To manage your medical information and emergency contacts, open the **Galaxy Wearable** app on your phone and tap **Watch settings** → **Safety and emergency**.

## Connecting the Watch to a phone

### Installing the Galaxy Wearable app

To connect your Watch to a phone, install the Galaxy Wearable app on the phone.

Depending on your phone, you can download the Galaxy Wearable app from the following places:

- Samsung Android phones: **Galaxy Store, Play Store**
  - Other Android phones: **Play Store**
-  • It is compatible with Android phones that support Google mobile services.
- You cannot install the Galaxy Wearable app on the phones that do not support Watch syncing. Ensure that your phone is compatible with a Watch.
  - You cannot connect your Watch to a tablet or a computer.

### Connecting the Watch to a phone through Bluetooth

- 1 Turn on the Watch.
- 2 Select a language to use and tap .
- 3 Select a country or region, and tap **Restart**.  
The Watch will turn off and then restart.
- 4 Swipe upwards from the bottom of the screen.  
On-screen instructions for opening the Galaxy Wearable app will appear.

5 Open the **Galaxy Wearable** app on your phone.

If the Galaxy Wearable app is not the latest version, update the Galaxy Wearable app to the latest version.

6 Tap **Continue**.

7 Select your Watch on the screen.

If you cannot find your Watch, tap **Having trouble connecting?**

8 Follow the on-screen instructions to complete the connection.



When completing the connection, tap **Start** and follow the on-screen instructions to learn about the Watch's basic controls.



- The initial setup screen may differ depending on your region.
- Connection methods may vary depending on your region, model, phone, and software version.
- The Watch is smaller than normal phones so the network quality may be lower, especially in areas with weak signals or poor reception. When a Bluetooth connection is unavailable, your cellular network or internet connection may be poor or become disconnected.
- When you connect your Watch to a phone for the first time or after resetting it, the Watch's battery may drain more quickly while syncing data, such as contacts.
- Supported phones and features may vary depending on your region, carrier, or device manufacturer.
- When you cannot establish a Bluetooth connection between your Watch and the phone, the status indicator  icon will appear at the top of the Watch screen.

## Connecting your Watch to a new phone

You can connect your Watch to a new phone that uses the same Google Account as your previous phone without resetting the Watch's data.

1 On the Apps screen, tap  (**Settings**) → **General** → **Transfer watch to new phone** → .

2 On your new phone, open the **Galaxy Wearable** app to connect to your Watch.



If you want to connect your Watch to a new phone after resetting the Watch, tap  (**Settings**) on the Apps screen and tap **General** → **Reset**.



## Remote connection

Your Watch and phone are connected through Bluetooth. You can sync your phone to your Watch when both devices are remotely connected to each other, even though a Bluetooth connection is not available. The Remote connection uses your mobile network or Wi-Fi.

If this feature is not turned on, open the **Galaxy Wearable** app on your phone, tap **Watch settings** → **Advanced features** → **Remote connection**, and then tap the switch to turn it on.

## Adding the accounts to your Watch

Register your Samsung or Google accounts on your connected phone and add them to your Watch to access the various Watch features.

### Registering a Samsung account on your Watch

- 1 Open the **Galaxy Wearable** app on your phone.
- 2 Tap **Watch settings** → **Accounts and backup**.
- 3 Tap **Samsung account** and follow the on-screen instructions to sign in to your Samsung account on your phone.  
If your Samsung account is signed in, you can check the registered Samsung account.

### Adding a Google Account to your Watch

- 1 Open the **Galaxy Wearable** app on your phone.
- 2 Tap **Watch settings** → **Accounts and backup**.
- 3 Tap **Google account**.
- 4 Tap **Add Google account** and follow the on-screen instructions to add your Google Account from the phone to your Watch.

# Controlling the screen

## Bezel

Your Watch has a touch bezel or a rotatable bezel. Rotate or swipe the bezel clockwise or anticlockwise to control various Watch functions.



Touch bezel  
(Galaxy Watch6)



Rotatable bezel  
(Galaxy Watch6 Classic)

- **Scrolling through screens:** Rotate or swipe the bezel to move to other screens.
  - **Moving from item to item:** Rotate or swipe the bezel to move from item to item.
  - **Adjusting the input value:** Rotate or swipe the bezel to adjust the volume or brightness. When adjusting the brightness, rotate or swipe the bezel clockwise to make the screen brighter.
  - **Using the phone or alarm feature:** Rotate or swipe the bezel clockwise to receive incoming calls or dismiss alarms. Rotate or swipe the bezel anticlockwise to decline incoming calls or to turn on the snooze feature for an alarm.
- ⚠ • Make sure the rotatable bezel is free from foreign materials like dust or sand.
- ⚠ • Do not use the rotatable bezel near magnetic substances, such as magnets or magnetic bracelets. The rotatable bezel may not work properly because of magnetic interference.
- 🔧 If the bezel does not work, take the Watch to a Samsung Service Centre or an authorised service centre without disassembling it.

## Touch screen

### Tapping

Tap the screen.

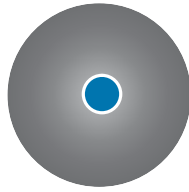

### Touching and holding

Touch and hold the screen for approximately 2 seconds.

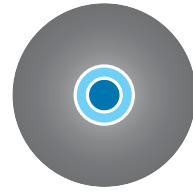

### Dragging

Touch and hold an item and drag it to the target position.

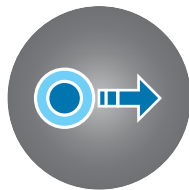

### Double tapping

Double tap the screen.

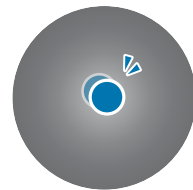

### Swiping

Swipe upwards, downwards, to the left, or to the right.

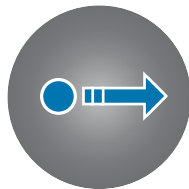

### Spreading and pinching

Spread two fingers apart or pinch on the screen.

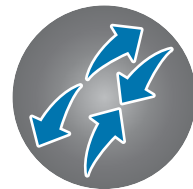

- ⚠ • Do not allow the touch screen to come into contact with other electrical devices. Electrostatic discharges can cause the touch screen to malfunction.
- To avoid damaging the touch screen, do not tap it with anything sharp or apply excessive pressure to it with your fingertips or other objects.
- It is recommended not to use fixed graphics on part or all of the touch screen for extended periods. Doing so may result in afterimages (screen burn-in) or ghosting.
- 📝 • The Watch may not recognise touch inputs close to the edges of the screen, which are outside of the touch input area.
- The touch screen may not be available when water lock mode is turned on.

## Screen composition

The Watch screen is the starting point of the Home screen, which is composed of several pages.

You can check tiles or open the notification panel by swiping the screen to the left or right or by using the bezel.



 The available panels, tiles, and their arrangement may vary depending on the software version.

## Using tiles

To add a tile, tap **Add tiles** and select a tile.



When touching and holding a tile, you can access the edit mode to change the tile's arrangement or remove the tiles.

- **Moving the tile:** Touch and hold a tile to move and drag it to the desired location.
- **Removing the tile:** Tap  on the tile to remove it.

## Turning the screen on and off

### Turning the screen on

Use the following methods to turn the screen on.

- **Turn the screen on with the buttons:** Press the Home button or Back button.
- **Turn the screen on by raising your wrist:** Raise your wrist where you wear the Watch. If the screen does not turn on after you raise your wrist, tap  (**Settings**) on the Apps screen, tap **Display**, and then tap the **Raise wrist to wake** switch under **Screen wake-up** to turn it on.
- **Turn the screen on by tapping the screen:** Tap the screen. If the screen does not turn on after you tap the screen, tap  (**Settings**) on the Apps screen, tap **Display**, and then tap the **Touch screen to wake** switch under **Screen wake-up** to turn it on.
- **Turn the screen on with the bezel:** Rotate the bezel. If the screen does not turn on after you rotate the bezel, tap  (**Settings**) on the Apps screen, tap **Display**, and then tap the **Turn bezel to wake** switch under **Screen wake-up** to turn it on (Galaxy Watch6 Classic).

### Turning the screen off

To turn off the screen, cover it with your palm or another object. Also, the screen will automatically turn off if the Watch is not used for a specified period.

## Switching the screen

### Switching between the Watch and Apps screen

On the Watch screen, swipe upwards to open the Apps screen.

To return to the Watch screen, swipe downwards from the top of the Apps screen. Alternatively, press the Home button or Back button.

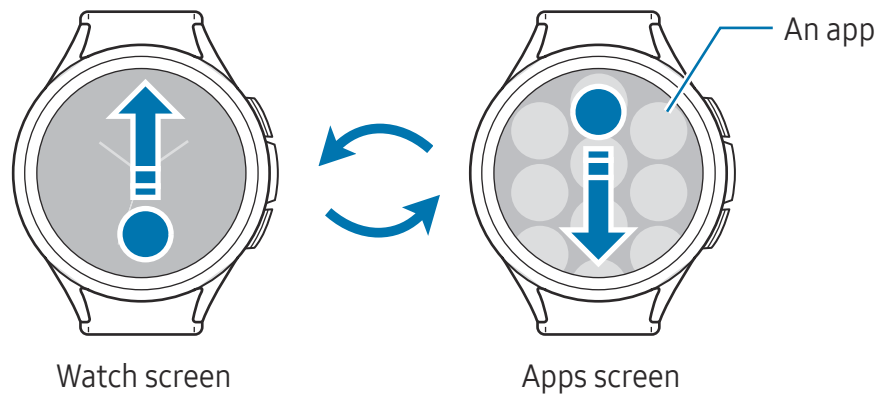

### Returning to the previous screen

To return to the previous screen, swipe right on the screen or press the Back button.

## Apps screen

The Apps screen displays icons for all apps installed on the Watch.

 The available apps may vary depending on the software version.

### Opening apps

On the Apps screen, tap an app icon to open the app.

To open an app from the list of recent apps, on the Apps screen, tap  (**Recent apps**).

### Closing apps

- 1 On the Apps screen, tap  (**Recent apps**).
- 2 Use the bezel or swipe left or right on the screen to move to the app to close.
- 3 Swipe upwards on the app to close it.

To close all opened apps, tap **Close all**.

## Editing the Apps screen

### Moving items

Drag an item to a new location.

### Creating folders

Drag an app over another app.

A new folder containing the selected apps will be created. Tap **Folder name** and enter a folder name.

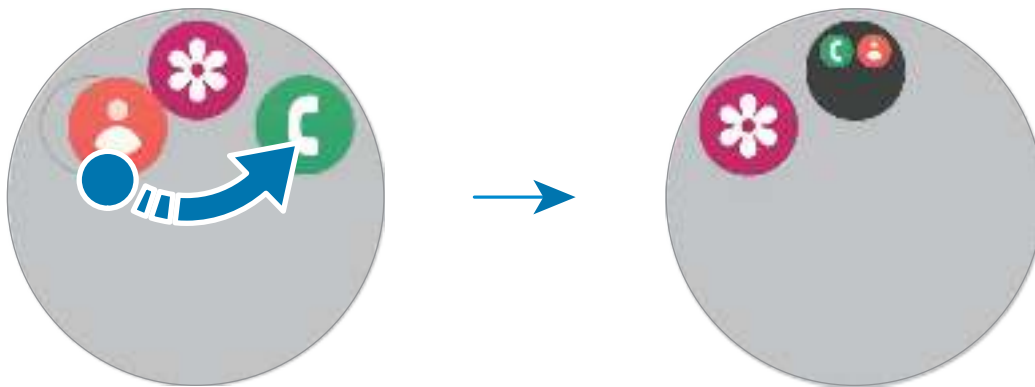

- **Adding more apps**

Tap **+** on the folder. Tick the apps to add and tap **Done**. You can also add an app by dragging it to the folder.

- **Moving apps from a folder**

Drag an app to a new location outside of the folder.

- **Deleting a folder**

Touch and hold a folder, and then tap **Delete**. Only the folder will be deleted. The folder's apps will be relocated to the Apps screen.

## Lock screen

Use the screen lock feature to protect your data, such as your personal information saved on your Watch. When turning on this feature, the Watch will require you to unlock it whenever you use it. However, if you unlock it once while wearing the Watch, it will remain unlocked.

### Setting the screen lock

On the Apps screen, tap  (Settings) → **Security and privacy** → **Lock type** and select the lock method.

- **Pattern:** Draw a pattern with four or more dots to unlock the screen.
- **PIN:** Enter a PIN with numbers to unlock the screen.

## Watch

### Watch screen

You can check the current time or check other information. When you are not on the Watch screen, press the Home button to return to the Watch screen.

### Changing the watch face

- 1 Touch and hold the Watch screen and tap **Add watch face**.
- 2 Use the bezel or swipe upwards or downwards on the screen, and then select a watch face.  
If you tap **More watch faces**, you can download more watch faces from the **Play Store** app.



- 3 Tap **Customise** to customise the watch face. Swipe left or right on the screen to move to an item you want to customise, and then select the desired colour and other things by using the bezel or swiping upwards or downwards on the screen. To set the complications, tap each complication area you want.



-  You can also change the watch face and customise it from your phone. Open the **Galaxy Wearable** app on your phone and tap **Watch faces**.

## Customising a watch face with a picture

Apply a picture as your watch face after importing a picture from your phone. Refer to [Transferring pictures to your Watch](#) for more information about importing pictures from a phone.

- 1 Touch and hold the Watch screen and tap **Add watch face**.
- 2 Tap **Photos**, **Pebbles**, or **Photo sticker**.
- 3 Tap **Customise**.
- 4 Swipe left or right on the screen to move to the **Background** or **Photo** item.

5 Tap the screen, select a picture to use as a watch face, and then tap **OK**.

To zoom in or out on the picture, double tap the picture, or spread two fingers apart or pinch the picture. When the picture is zoomed in, swipe the screen to make a part of the picture appear on the screen.





- To select several pictures at the same time, touch and hold a picture, select pictures by using the bezel or swiping left or right on the screen, and then tap . To add extra pictures after selecting pictures, tap **Add photo**. However, if you are selecting **Photo sticker** for the watch face, you can only select one picture.
- Up to 20 pictures can be added as the watch face when you are selecting **Photos** or **Pebbles** for the watch face.
- The pictures you add will appear when you tap the screen when you are selecting **Photos** for the watch face.

6 Tap **OK**.

7 Swipe the screen to change other items, such as complication, and return to the previous screen.

## Turning on the Always On Display feature

Set the Watch screen and some apps' screens to always stay on while wearing your Watch. However, the battery will drain more quickly than normal while using this feature.

To use this feature, open the quick panel by dragging downwards from the top edge of the screen and tap . Alternatively, on the Apps screen, tap  (**Settings**) → **Display** and tap the **Always On Display** switch to turn it on.

## Turning on watch only mode

In watch only mode, only the time will display and all other functions cannot be used.

On the Apps screen, tap  (**Settings**) → **Battery and device care** → **Battery** → **Watch only** and tap **Turn on**.

To turn off watch only mode, press and hold the Home button. Alternatively, place the Watch on the wireless charger.



# Notifications

## Notification panel

Check a notification such as a new message or a missed call on the notification panel. On the Watch screen, rotate or swipe the bezel anticlockwise. Alternatively, swipe right on the screen to open the notification panel.

When there are new notifications, an orange notification indicator will appear on the Watch screen. If the notification indicator does not appear, on the Apps screen, tap  (**Settings**) → **Notifications** → **Advanced settings** and tap the **Notification indicator** switch to turn it on.



-  You can receive notifications only when wearing the Watch.
- You cannot receive notifications on your Watch when using your phone. To check notifications on your Watch even while you are using your phone, tap  (**Settings**) on the Apps screen, tap **Notifications** → **Show phone notifications on watch**, and then select **Show alerts even when phone in use**.

## Checking incoming notifications

When you receive a notification, information about the notification, such as its type or the time you received it, will appear on the screen. If more than two notifications are received, use the bezel or swipe left or right on the screen to check more notifications. Tap the notification to check the details.

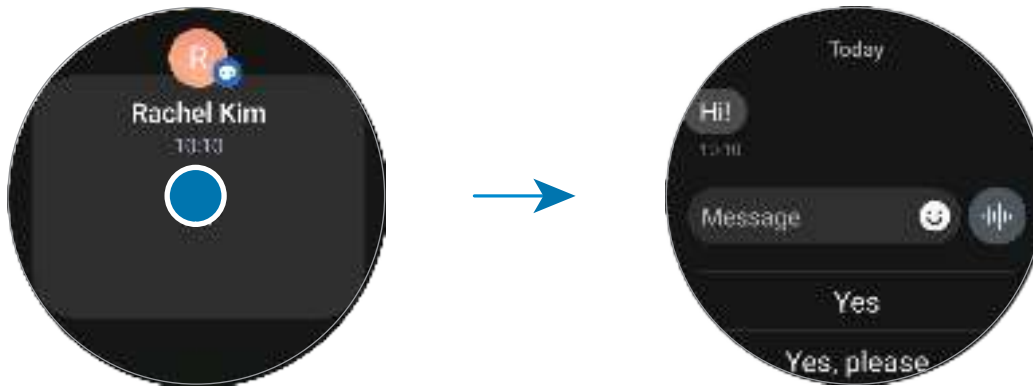

## Deleting notifications

Swipe upwards on the screen while checking a notification.

## Selecting apps for receiving notifications

Select a phone or Watch app to receive notifications for on your Watch.

- 1 Open the **Galaxy Wearable** app on your phone.
- 2 Tap **Watch settings** → **Notifications** → **App notifications**.
- 3 Tap the switch next to apps to receive notifications from the apps list.

## Quick panel

Check the Watch's current status and configure settings from the quick panel.





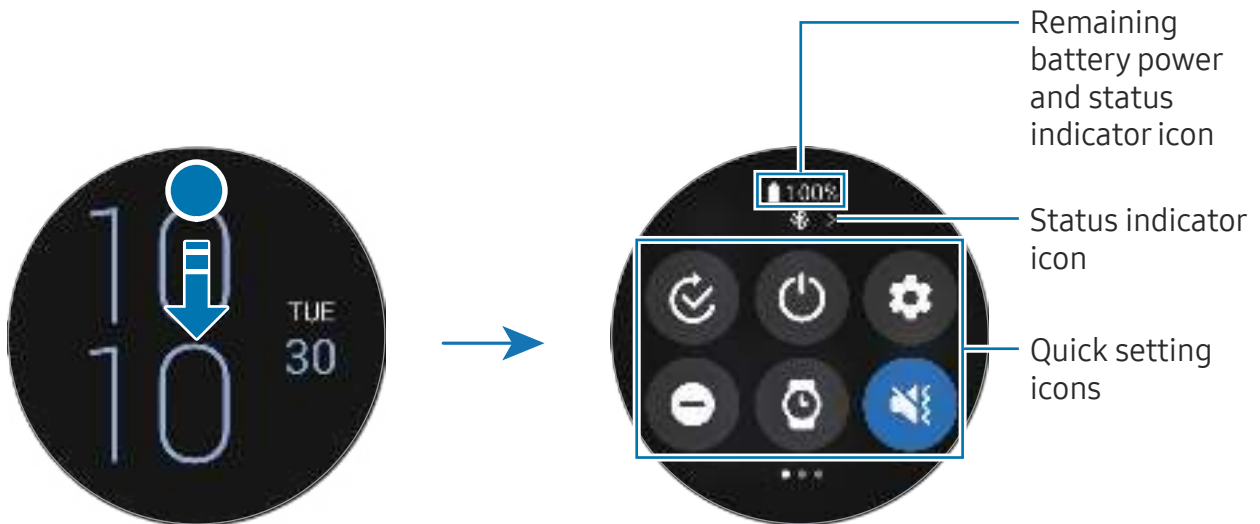

To open the quick panel, drag downwards from the top edge of the screen. To close the quick panel, swipe upwards on the screen.



Use the bezel or swipe left or right on the screen to move to the next or previous quick panel.



### Checking the status indicator icons

Status indicator icons appear at the top of the quick panel and inform you of the Watch's current status. The icons listed in the table are the most common.















Icon	Meaning
	Bluetooth connected
	Signal strength
	LTE network connected
	Wi-Fi connected
	Watch and phone are remotely connected
	Battery power level







-  Some status indicator icons that show certain situations, such as when you use some modes or charge the Watch, also appear at the top of the Watch screen. To hide the status indicator icons on the Watch screen, tap  (**Settings**) on the Apps screen, tap **Advanced features** → **Status indicators**, and then select **Hide after 2 seconds**.
- The status indicator icons may appear differently depending on the region, carrier, or model.

## Checking quick settings icons

Quick settings icons appear on the quick panel. Tap the icon to change the basic settings or launch the feature. To check more detailed settings, touch and hold a quick settings icon.

Refer to [Editing a quick panel](#) for more information about adding or removing the quick settings icons on the quick panel.

Icon	Meaning
	Open the Select mode menu
	Access the power options
	Open <b>Settings</b>
	Turn on do not disturb mode
	Turn on the Always On Display feature
	Turn on sound, vibrate, or silent mode
	Turn on the flash
	Adjust the brightness
	Turn on power saving mode
	Open the volume menu
	Connect the Wi-Fi network
	Turn on water lock mode
	Turn on flight mode
	Connect the Bluetooth headset



Icon	Meaning
	Open the <b>Find My Phone</b> app
	Turn on the GPS feature
	Connect the mobile network (SM-R935F, SM-R945F, SM-R955F, SM-R965F)
	Turn on the NFC feature
	Turn on the touch sensitivity feature
	Connect to Bluetooth (SM-R935F, SM-R945F, SM-R955F, SM-R965F)



- The  quick setting icon may appear differently depending on the running mode, and you can turn off the mode by tapping the icon when the mode is being used.
- The quick setting icons may appear differently depending on the software version of the connected phone.

## Editing a quick panel

Tap  to access the edit mode to change the quick settings icon's arrangement, or add or remove the quick settings icon.

- **Moving the quick setting icon:** Touch and hold a quick settings icon to move and drag it to the desired location.
- **Adding the quick setting icon:** Tap  on the quick settings icon to add.
- **Removing the quick setting icon:** Tap  on the quick settings icon to remove.

## Entering text

### Keyboard layout

A keyboard appears when you enter text.



- The text input screen may be different depending on the app you open.
- Text entry is not supported in some languages. To enter text, you must change the input language to one of the supported languages.

### Changing the input language

Drag the — icon upwards, tap  → **Input languages** → **Manage languages**, and then select the languages to use. When you select two languages, you can switch between the input languages by swiping to the left or right on the space key. You can add up to two languages.

- You can also set the input languages by tapping  (**Settings**) on the Apps screen and tapping **General** → **Input** → **Samsung Keyboard** → **Input languages** → **Manage languages**.

### Changing the keyboard type

Drag the — icon upwards, tap  → **Input languages**, select a language, and then select the keyboard type you want.

- On a **3 x 4** keyboard, a key has three or four characters. To enter a character, tap the corresponding key repeatedly until the desired character appears.



## Additional keyboard functions

Drag the — icon upwards on the keyboard screen to use additional keyboard functions.

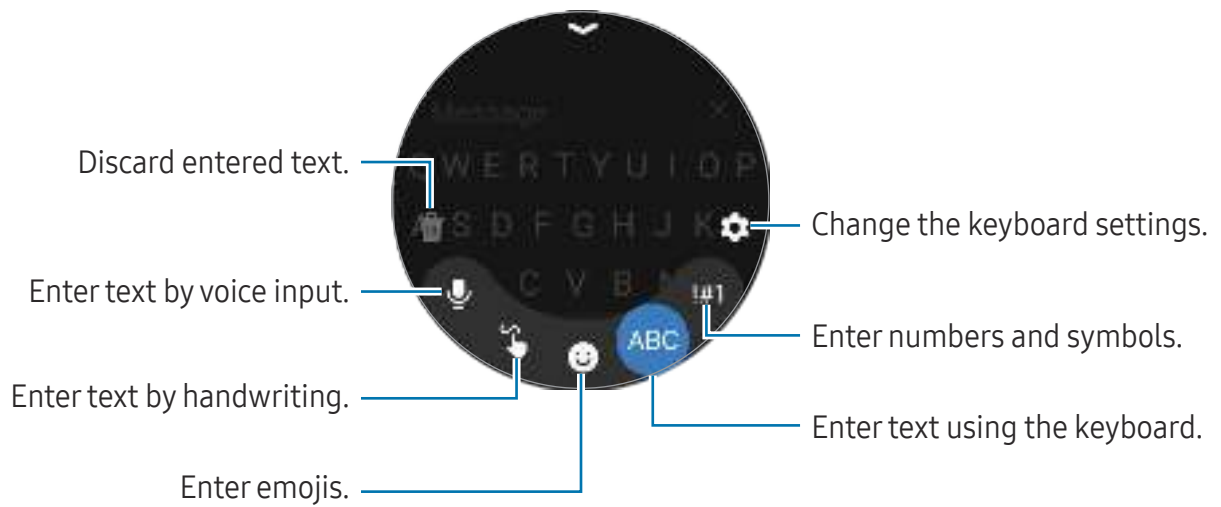



 Some features may not be available depending on the language, carrier, or model.

# Apps and features

## Installing and managing apps

### Play Store

Purchase and download apps.

Tap  (**Play Store**) on the Apps screen. Browse apps by category or tap  and search for a keyword.

-  • Register the Google Account on your Watch to use the Play Store app. Refer to [Adding a Google Account to your Watch](#) for more information.
- To change the auto-update settings, tap **Settings** and tap the **Auto-update apps** switch to turn it on or off.

### Managing apps

#### Uninstalling or disabling apps

Open the **Galaxy Wearable** app on your phone, tap **Watch settings** → **Apps**, tap an app, and then select an option.

- **Uninstall:** Uninstall downloaded apps.
  - **Disable:** Disable selected default apps that cannot be uninstalled from the Watch.
-  • Some apps may not support this feature.
- Some apps can be removed by touching and holding the app on the Watch's Apps screen and tapping **Uninstall**.

#### Enabling apps

Open the **Galaxy Wearable** app on your phone, tap **Watch settings** → **Apps**, select , and then tap **Disabled** → **OK**. Select an app and tap **Enable**.

## Setting app permissions

For some apps to operate properly, they may need permission to access or use information on your Watch.

To check or change app permission settings by permission category, on the Apps screen, tap  (**Settings**) → **Apps** → **Permission manager**. Select an item and select an app.

 If you do not grant permissions to apps, the basic features of the apps may not function properly.

## Messages

Check messages and reply to using the Watch.

You may incur additional charges for sending or receiving messages when you are roaming.

 The Android Messages app may be available depending on the region, and the settings for the default messages app are synced with the connected phone.

## Checking messages

1 Tap  (**Messages**) on the Apps screen.

Or, open the notification panel and check a new message.

2 Scroll through the message list or use the bezel, and then select a contact to check your conversations.





To check a message on your phone, tap **Show on phone**.

To reply to a message, tap the message input field and enter a message.

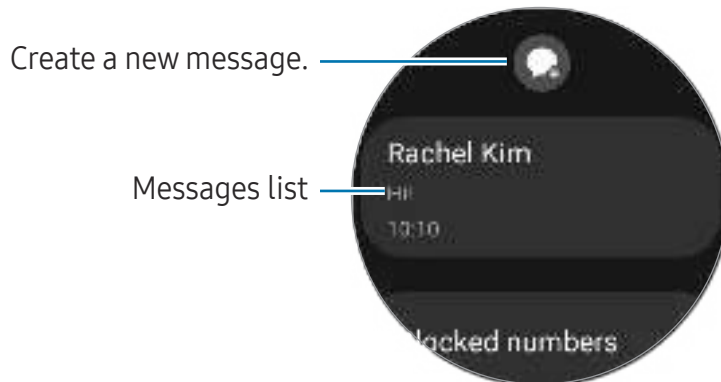
## Sending messages



- 1 Tap  (**Messages**) on the Apps screen.



- 2 Tap .
- 3 Tap **Recipient** or tap  to enter a message recipient or phone number. Or, tap  and select a message recipient from the contacts list.
- 4 Tap the message input field and enter a message or select a text template, and then tap  or .

### Recording and sending a voice message

You can send a voice file after recording what you want to say.

On the message input screen, tap , record what you want to be sent, and then tap .

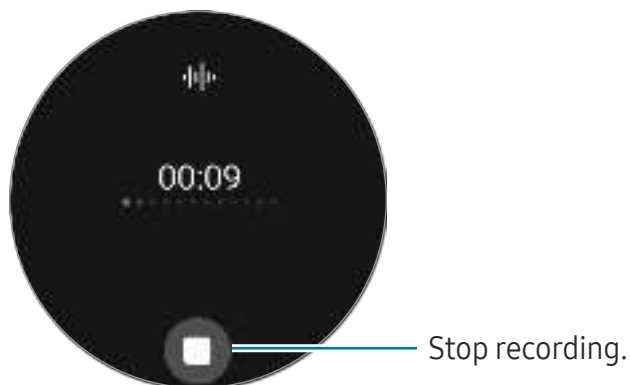

## Deleting messages

- 1 Tap  (**Messages**) on the Apps screen.
- 2 Scroll through the message list or use the bezel, and then select a contact to check your conversations.
- 3 Touch and hold a message, then tap **Delete**.  
The message will be deleted both from the Watch and the connected phone.

## Phone

### Introduction

You can make calls and check incoming calls and receive them.



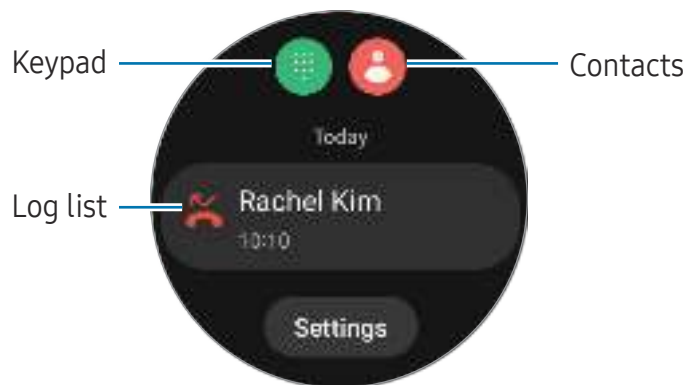

-  The sound may not be heard clearly during a call and only brief calls are available in areas with weak signals.

### Making calls

Tap  (**Phone**) on the Apps screen.







Use one of the following methods to make calls.

- Tap , enter a number using the keypad, and then tap .
- Tap , use the bezel or scroll through the contact list, select a contact, and then tap .
- Use the bezel or scroll through the log list, select a log entry, and then tap .

## Selecting the number to use for making calls (SM-R935F, SM-R945F, SM-R955F, SM-R965F)

You can select the number you want to use between the Watch's number and the connected phone's number when making calls. Also, if your Watch is connected to a phone that supports dual SIM cards, you can select a SIM card to make calls.

- 1 Tap  (**Phone**) on the Apps screen.
  - 2 Tap .
  - 3 Tap  and select the option you want.
    - **Phone**: Make calls with the number of the connected phone.
    - **SIM 1**: Make calls with the number of the connected phone's SIM card 1.
    - **SIM 2**: Make calls with the number of the connected phone's SIM card 2.
    - **Watch**: Make calls with the Watch's number.
-  • Some features may not be available depending on the connected phone.
- You can also select a number to use by touching and holding the call button after selecting a log entry.

## Setting a preferred number in advance (SM-R935F, SM-R945F, SM-R955F, SM-R965F)

- 1 Tap  (**Phone**) on the Apps screen.
- 2 Tap **Settings**.
- 3 Tap **Preferred number** and select the option you want.
  - **Phone**: Set to make calls with the number of the connected phone.
  - **Watch**: Set to make calls with the Watch's number.
  - **Always ask**: Set to always ask which number to use whenever making calls.

## Options during calls

The following actions are available:

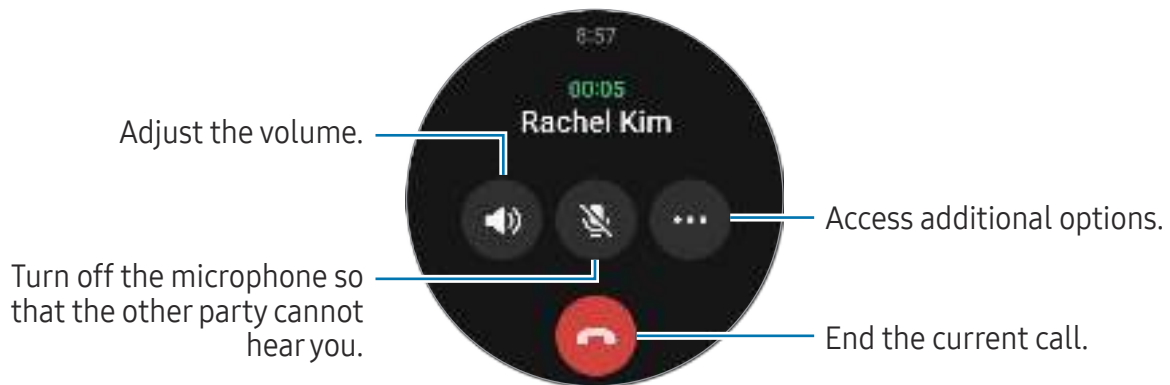

 The screen's appearance may differ depending on the model.

## Making a phone call with a Bluetooth headset

When a Bluetooth headset is connected, the call will be directed to it.

While the Bluetooth headset is not connected, on the Apps screen, tap  (**Settings**) → **Connections** → **Bluetooth**. When the available Bluetooth devices list appears, select a Bluetooth headset you want to use.

## Receiving calls

### Answering a call

When a call comes in, rotate or swipe the bezel clockwise. Alternatively, drag  outside the large circle.

You can have phone conversations using the Watch's internal microphone, speaker, or a connected Bluetooth headset.

### Declining a call

You can decline incoming calls and send a declining message to the caller.

When a call comes in, rotate or swipe the bezel anticlockwise. Alternatively, drag  outside the large circle.

To send a declining message, drag the  icon upwards and select the message you want.

## Missed calls

If a call is missed, a missed call notification appears on the notification panel. On the notification panel, check missed call notifications. Alternatively, tap  (**Phone**) on the Apps screen to check missed calls.

## Contacts

You can make a call or send a message to a contact. The contacts saved on your connected phone will be also saved to your Watch.



Tap  (**Contacts**) on the Apps screen.

 The favourite contacts list on the phone will appear on the top of the contacts list.

Use one of the following search methods:

- Tap  and enter the search criteria on the top of the contacts list.
- Scroll through the contacts list.
- Use the bezel. When you rotate or swipe the bezel quickly, the list scrolls by the alphabet of the first letter.

Once a contact is selected, take one of the following actions:

-  : Make a voice call.
-  : Compose a message.

## Selecting the frequently used contacts on the tile

Add the frequently used contacts from the **Contacts** tile to contact them directly through a text message or phone call. Tap **Add** →  and select contact.

-  • To use this feature, you must add the **Contacts** tile. Refer to [Using tiles](#) for more information.
- Up to four contacts can be added on the tile.



## Samsung Wallet

Use various convenient features in Samsung Wallet. You can make a payment, check tickets or boarding passes, and more.

Tap  (**Samsung Wallet**) on the Apps screen and select a feature you want.



- This app may not be available depending on the region, carrier, model, or connected phone.
- Some features may not be available depending on the region.
- The procedures for the initial setup may vary depending on the region or carrier.

### Setting up Samsung Wallet

- 1 Open the **Galaxy Wearable** app on your phone.
- 2 Tap **Watch settings** → **Samsung Wallet** and follow the on-screen instructions to complete the setup.

### Making payments

Register cards to Samsung Pay to make payments. Refer to [Samsung Pay](#) for more information.

### Using tickets

Add boarding passes and tickets for movies, sports, and more, to access and use them in one place.

# Samsung Pay

## Introduction

Register cards to Samsung Pay to make payments.

You can check out more information, such as cards that support this feature at [www.samsung.com/samsung-pay](http://www.samsung.com/samsung-pay).



- To make payments with Samsung Pay, the device may be required a connection to a Wi-Fi or mobile network depending on the region.
- This app may not be available depending on the region, carrier, model, or connected phone.
- The procedures for the initial setup and card registration may vary depending on the region or carrier.

## Setting up Samsung Pay

- 1 Open the **Galaxy Wearable** app on your phone.
- 2 Tap **Watch settings** → **Samsung Pay** and follow the on-screen instructions to complete your card registration.

## Making payments

- 1 To make a payment on your Watch, press and hold the Back button on the Watch screen or on the Samsung Pay intro page.
- 2 Enter your PIN or draw the pattern you set.
- 3 Scroll through the cards list, select a card, and then tap **PAY**.

4 Place your Watch close to the card reader.

When the card reader recognises the card information, the payment will be processed.



- ☑ Payments may not be processed depending on your network connection.
- The verification method for payments may vary depending on the card readers.

## Samsung Health

### Introduction

Samsung Health records and manages your 24-hour activity and sleep pattern to cultivate a healthy habit. You can save and manage health-related data on the Samsung Health app of the connected phone.

After continuously exercising for more than 10 minutes (for running, 3 minutes) while wearing the Watch, the auto detect workouts feature will be turned on. Also, the Watch will notify you and show you some stretching motions to follow or it will show you a screen encouraging you to engage in light activity when the Watch recognises inactivity for more than 50 minutes. When your Watch recognises that you are driving or sleeping, it may not notify you and not show a stretching screen although you are physically inactive.

Visit [www.samsung.com/samsung-health](http://www.samsung.com/samsung-health) for more information.

- ☑ Samsung Health features are intended only for leisure, well-being, and fitness purposes. They are not intended for medical use. Before using these features, read the instructions carefully.

## Daily activity

Check your current daily status, such as steps, active times, activity calories, and their targets, and related information.

### Checking your daily activity

Tap  (**Samsung Health**) on the Apps screen and tap **Daily activity**.

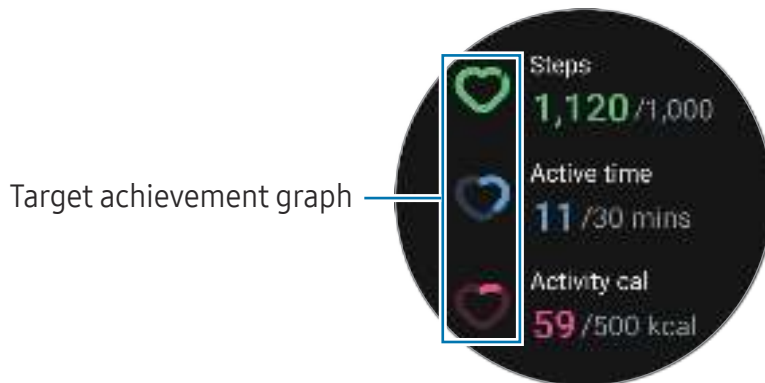

- **Steps:** Check the amount of steps you walk throughout the day. As you approach your step target, the graph will increase.
- **Active time:** Check the total time you were physically active throughout the day. As you approach your active time target by doing light activities, such as stretching, or walking, the graph will increase.
- **Activity cal:** Check the total amount of calories you spent doing an activity throughout the day. As you approach your activity calories target, the graph will increase.

To check additional information which is related to your daily activity, use the bezel or swipe upwards or downwards on the screen.

### Setting the daily activity target

- 1 Tap  (**Samsung Health**) on the Apps screen.
- 2 Tap **Daily activity** and tap **Set targets**.
- 3 Select an activity option.
- 4 Use the bezel or swipe upwards or downwards on the screen to set the target.
- 5 Tap **Done**.

## Steps

The Watch counts the number of steps you have taken.

### Measuring your step count

Tap  (Samsung Health) on the Apps screen and tap **Steps**.

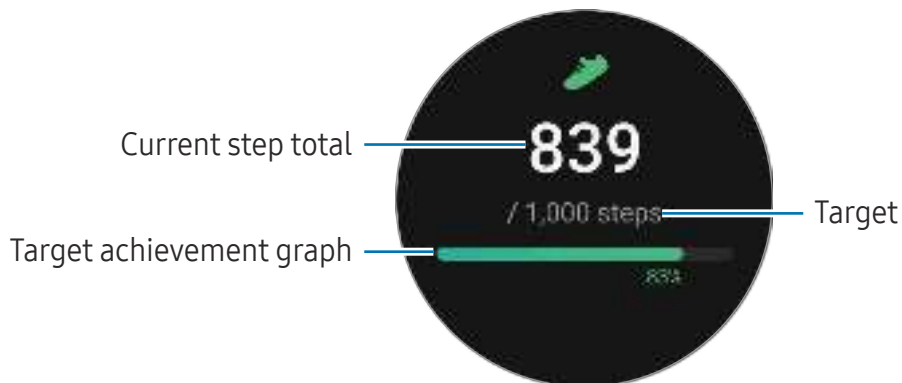

To check additional information which is related to the steps, use the bezel or swipe upwards or downwards on the screen.

-  • When you start to measure your step count, the step tracker monitors your steps and shows your step count after a brief delay because your Watch accurately recognises your movement after you walk for a while. Also, for an accurate step count, you may experience a brief delay before the notification indicates that a certain goal has been reached and this notification will appear only when using the Samsung Health app after downloading and installing the app.
- If you use the steps tracker while travelling by car or train, vibration may affect your step count.
- One floor is calculated as approximately 3 metres. The floors measured may not match the actual floors you climb.
- The floors measured may not be accurate depending on the environment, the user's movements, and the conditions of buildings.
- The floors measured may not be accurate if water (shower and water activity) or foreign materials enter the atmospheric pressure sensor. If there is any detergent, sweat, or raindrops on the Watch, rinse it with clean water and dry the Watch, including the atmospheric pressure sensor thoroughly before use.

## Setting the step target

- 1 Tap  (Samsung Health) on the Apps screen.
- 2 Tap **Steps** and tap **Set target**.
- 3 Use the bezel or swipe upwards or downwards on the screen to set the target.
- 4 Tap **Done**.

## Exercise

Record your exercise information and check the results.





- Before using this feature, seek the advice of a licensed medical professional, such as a doctor, if any of the following apply to you:
  - If you have a chronic medical condition, such as heart disease or high blood pressure
  - If you are pregnant
  - If you are not of the appropriate age to exercise independently
- If you feel dizzy, experience pain, or have difficulty breathing during exercise, stop exercising immediately and seek the advice of a licensed medical professional, such as a doctor.
- Your heart rate is measured when you start exercising. For accurate measurements, wear the Watch firmly around your lower arm above the wrist. Refer to [How to wear the Watch for accurate measurements](#) for more information.
- Do not move until your heart rate appears on the screen so it can be measured more accurately.
- Your heart rate may not appear temporarily because of various conditions such as the environment, your physical state, or how the Watch is worn.

### **Be aware of following conditions before exercising in cold weather conditions:**

- Avoid using the device in cold weather. If possible, use the device indoors.
- If you use the device outside in cold weather, cover the Watch with your sleeves before using it.

## Starting exercises

- 1 Tap  (**Samsung Health**) on the Apps screen.
- 2 Tap **Work out**.
  -  You can start exercising directly from the **Multi-workouts** tile after adding workouts to it.
- 3 Use the bezel or swipe left or right on the screen to select an exercise type you want. When there is no exercise type you want, tap **Add**, and then select an exercise type you want.



The exercise will begin. For certain exercise types, tap **Start** to initiate the exercise.

- 4 Use the bezel or swipe upwards or downwards on the screen to check exercise information, such as your heart rate, distance, or time, on the workout screen.

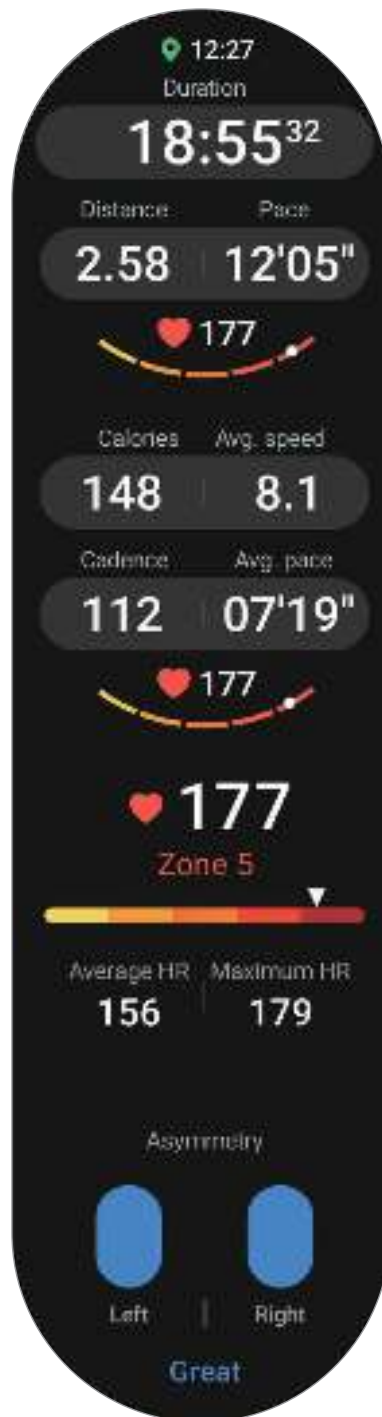

You can play music by swiping left on the screen.



-  • When you select **Swimming** or **Swimming (outdoor)**, water lock mode will be automatically turned on and the touch screen will be unresponsive. Water lock mode is a feature that prevents unintentional screen touches and inputs when exercising in the water. When water lock mode is on, the features, such as the raise wrist to wake feature and Always On Display feature, including screen touches are automatically turned off.
- When you select **Swimming** or **Swimming (outdoor)**, the recorded value may not be accurate in following cases:
  - If you stop swimming before reaching the completion point
  - If you change your swimming stroke midstream
  - If you stop moving your arms before reaching the completion point
  - If you swim without moving your arms
  - If you swim with only one arm
  - If you swim under water
  - If you get out of the water and walk after starting the exercise
  - If you do not pause or restart the exercise, but finish the exercise while resting

5 Swipe right on the screen and tap **Finish**.

To pause or restart the exercise, swipe right on the screen and tap **Pause** or **Resume**. Alternatively, press and hold the Back button.

-  • To finish swimming, first press and hold the Home button to turn off water lock mode, shake your Watch to completely remove any water from it to ensure that the atmospheric pressure sensor will work properly, and then tap **OK**.
- Music will continue to play even if you finish exercising. To stop playing music, stop music before finishing exercising or open the **Music** app or **Media Controller** app to stop playing music.

6 Use the bezel or swipe upwards or downwards on the screen after finishing the exercise to check your exercise results.

## Doing multiple exercises

You can log various exercises and go straight through an entire routine by starting another exercise right after finishing the current exercise.

Swipe right on the screen while working out, tap **New**, and then select the next exercise type to begin.

-  To finish swimming, first press and hold the Home button to turn off water lock mode, shake your Watch to completely remove any water from it to ensure that the atmospheric pressure sensor will work properly, and then tap **OK**.

## Starting repetitive exercises

When you perform repetitive exercises such as squats or deadlifts, your Watch will count how many times you repeat the motion with beeping.

- 1 Tap  (**Samsung Health**) on the Apps screen.
- 2 Tap **Work out**.
- 3 Use the bezel or swipe left or right on the screen to select a type of repetitive exercise you want and begin.

When there is no repetitive exercise type you want, tap **Add**, and then select an exercise type you want.



- 4 Tap **OK** and get into the proper position to start by following the pose on the screen.



Counting will begin with beeping.

- 5 Use the bezel or swipe upwards or downwards on the screen to check exercise information, such as your heart rate, the number of repetition, or calories, on the workout screen.

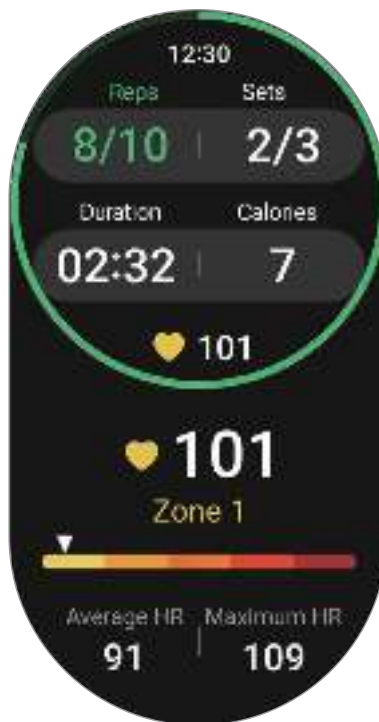

You can play music by swiping left on the screen.

- 6 Take a rest after completing a set. Or, tap **Skip** if you want to skip to the next set without resting.

The exercise will begin after you get into the proper position to start it by following the pose on the screen.

- 7 Swipe right on the screen and tap **Finish**.

To pause or restart the exercise, swipe right on the screen and tap **Pause** or **Resume**. Alternatively, press and hold the Back button.

-  Music will continue to play even if you finish exercising. To stop playing music, stop music before finishing exercising or open the **Music** app or **Media Controller** app to stop playing music.

- 8 Use the bezel or swipe upwards or downwards on the screen after finishing the exercise to check your exercise results.

## Checking the exercise history

You can check your exercise history, which is sorted by date and exercise type.

- 1 Tap  (**Samsung Health**) on the Apps screen.
- 2 Tap **View history**.

- 3 Use the bezel or swipe upwards or downwards on the screen to check all your exercise history.

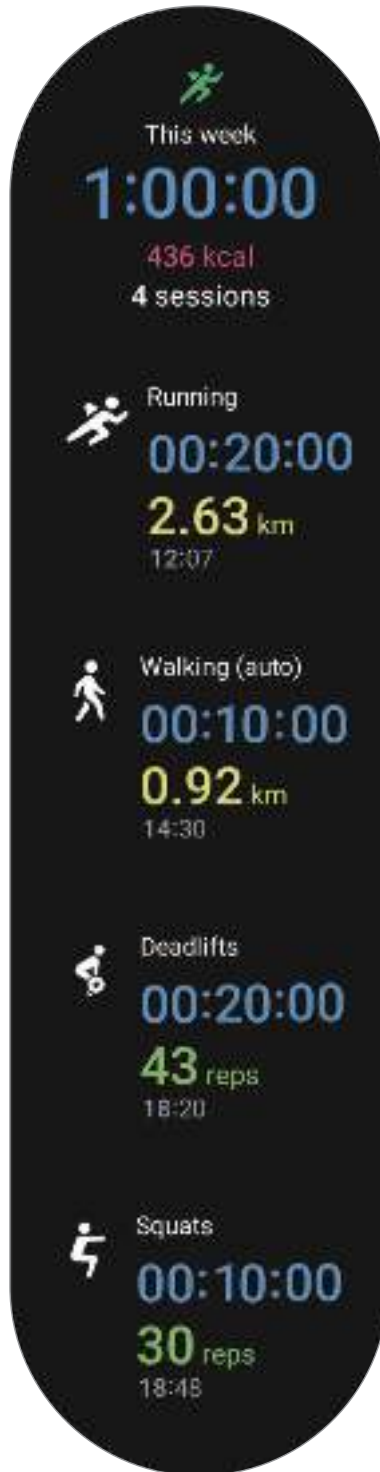

## Working out after adding your own exercise



In addition to the default exercise types provided by your Watch, you can add your own exercises, and measure the duration and calories burned, and then check your exercise results.

- 1 Tap  (**Samsung Health**) on the Apps screen.
- 2 Tap **Work out**.
- 3 Tap **Add** → **Create new exercise**.
- 4 Enter a name and tap the **Record distance, speed, and route with GPS** switch to record additional options.
- 5 Tap **Save**.  
Your exercise will be added.



- 6 Select the exercise you added and begin.

## Setting the exercise

- 1 Tap  (**Samsung Health**) on the Apps screen.
  - 2 Tap **Work out**.
  - 3 Tap  under each exercise type and set the various exercise options.
    - **Pool length**: Set the pool length.
    - **Target**: Turn on the exercise target feature and set it.
    - **Workout screen**: Set the screens that appear while you are working out.
    - **HR zone guide**: Turn the feature on and set to receive alerts once you reach the heart rate zone goal you set.
    - **Auto lap**: Set to record the lap time manually by pressing the Back button twice or automatically at the distance or time you set while working out.
    - **Guide frequency**: Set to receive guidance whenever you reach the distance, time, or length you set.
    - **Coaching messages**: Set to receive coaching messages for proper pacing while working out.
    - **Auto pause**: Set the Watch's exercise feature to pause automatically when you stop working out.
    - **Workout start**: Set how to start working out.
    - **Audio guide**: Turn the audio guide on to check your target and laps by audio.
    - **Screen always on**: Set to turn the screen always on during workouts.
    - **Auto detect workouts**: Turn the auto detect workouts feature on and set it. Refer to [Auto detect workouts feature](#) for more information.
-  • You can also change certain settings right before starting the exercise or while exercising. Before starting the exercise, tap **Settings** on the countdown screen or GPS screen. Alternatively, while working out, swipe right on the screen and tap **Settings**.
- The available exercise setting options may vary depending on the exercise type.

## Auto detect workouts feature

Once you have engaged in an activity for more than 10 minutes (for running, 3 minutes) while wearing the Watch, it automatically recognises that you are exercising and records exercise information such as the exercise type, duration, and calories burned.



When you stop doing some exercises for more than one minute, the Watch automatically recognises that you have stopped exercising and recording will end.

- You can check the list of exercises that are supported by the auto detect workouts feature. On the Apps screen, tap  (**Samsung Health**) and tap **Settings** → **Activities to detect**. If the exercises are not recognised automatically, turn on the auto detect workouts feature and tap the switch of the exercise type that uses this feature under **Activities to detect**.
- The auto detect workouts feature measures something, such as the time you spent exercising and calories burnt by using the acceleration sensor. The measurements may not be accurate depending on your manner of walking, exercise routines, and lifestyle.



## Food

Record the calories you eat in a day and compare with your target calories to get help to manage your weight.

### Recording the calories

- 1 Tap  (**Samsung Health**) on the Apps screen.
- 2 Tap **Food**.
- 3 Tap **Enter**, tap the meal type on the top of the screen, and then select an option.
- 4 Use the bezel or swipe upwards or downwards on the screen to set the caloric intake, and then tap **Done**.

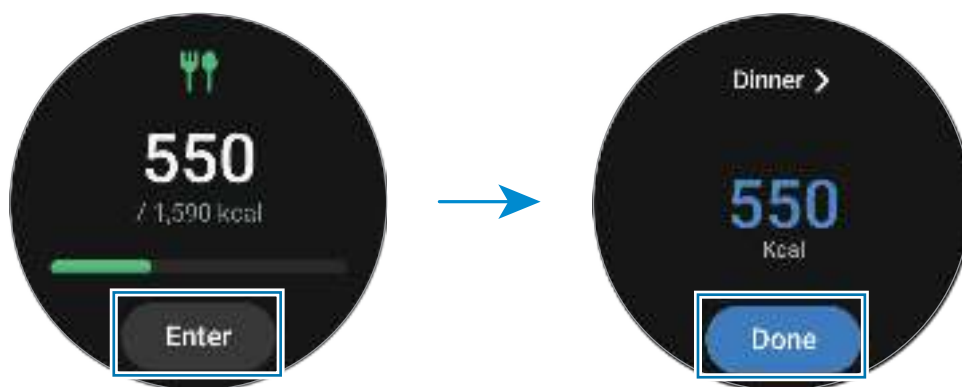

To check additional information which is related to the caloric intake, use the bezel or swipe upwards or downwards on the screen.

### Deleting logs



- 1 Tap  (**Samsung Health**) on the Apps screen.
- 2 Tap **Food** and tap **Delete**.
- 3 Select data to delete and tap **Delete**.

### Setting your caloric intake target

- 1 Tap  (**Samsung Health**) on the Apps screen.
- 2 Tap **Food** and tap **Set target**.
- 3 Use the bezel or swipe upwards or downwards on the screen to set the target.
- 4 Tap **Done**.

## Sleep

Analyse your sleep and record it by measuring your heart rate and your movement while you are sleeping.

-  This feature is only for your general wellness and fitness. Therefore, do not use it for medical purposes, such as diagnosing the symptoms, treatment, or prevention of disease.
- 
  - The sleep pattern will have its four states (Awake, REM, Light, Deep) analysed by using your movement and changes in your heart rate while you are sleeping. You can check the recommended ranges for each measured sleep state in the graph on your connected phone.
  - If your heart rate is irregular or your Watch cannot recognise your heart rate properly, the sleep pattern will be analysed into three states (Restless, Light, Motionless).
  - You can check the detailed sleep analysis only when your Watch is connected to your phone.
  - Before measuring, charge the Watch's battery so it is more than 30%.
  - For accurate measurements, wear the Watch firmly around your lower arm above the wrist. Refer to [How to wear the Watch for accurate measurements](#) for more information.



### Measuring your sleep

- 1 Sleep while wearing the Watch.  
The Watch will start to measure your sleep.
- 2 Tap  (**Samsung Health**) on the Apps screen after you wake up.
- 3 Tap **Sleep**.

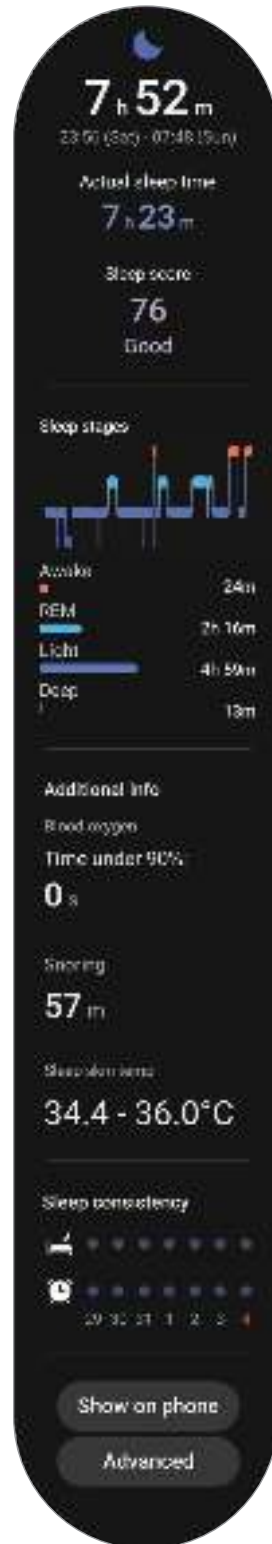
- 4 Use the bezel or swipe upwards or downwards on the screen to check all information related to your measured sleep.



## Using the snore detection feature

- 1 Tap  (**Samsung Health**) on the Apps screen.
  - 2 Tap **Settings**.
  - 3 Tap **Snore detection**.  
The Samsung Health app will open on your phone.
  - 4 Tap the switch to turn it on.
  - 5 Select **Always** under **Detect snoring** to measure your snoring whenever you are sleeping.
  - 6 Connect your phone to the charger and place the phone's microphone so it faces you before sleeping.  
Your snoring will be measured along with your other sleep records when you sleep while wearing the Watch.
-  • The snore detection feature can be turned on in the Samsung Health app (version 6.18 or later) of the connected phone.
  - Snoring may not be measured if you do not set the snore detection feature to **Always**, do not connect your phone to the charger before sleeping, or do not place the phone's microphone so it faces you before sleeping.

## Using the skin temperature during sleeping feature

Record the change in your skin temperature while you sleep and receive assistance in creating an optimal sleeping environment.

- 1 Tap  (**Samsung Health**) on the Apps screen.
- 2 Tap **Settings**.



### 3 Tap the **Skin temperature during sleep** switch to turn it on.

Your skin temperature will be measured along with your other sleep records when you sleep while wearing the Watch.

-  • If your skin temperature is measured continuously while sleeping, the battery will drain more quickly than normal.
- You can see the light because of the flickering optical heart rate sensor while measuring your skin temperature.
- The Watch may measure your skin temperature even if you are not sleeping because your Watch can recognise your sleep status even while reading books or watching TVs or movies.
- Wear the Watch firmly to ensure that you will not create space between your wrist and the Watch when turning over in your sleep.

## Heart rate

Measure and record your heart rate.

-  The Watch's heart rate tracker is intended for fitness and informational purposes only and is not intended for use in the diagnosis of disease or other conditions, or in the cure, mitigation, treatment, or prevention of disease.
-  For accurate measurements, wear the Watch firmly around your lower arm above the wrist. Refer to [How to wear the Watch for accurate measurements](#) for more information.

### **Be aware of following conditions before measuring your heart rate:**

- Rest for five minutes before taking measurements.
- If the measurement is very different from the expected heart rate, rest for 30 minutes and then measure it again.
- During winter or in cold weather, keep yourself warm when measuring your heart rate.
- Smoking or consuming alcohol before taking measurements increases heart rate and may cause your heart rate to be different from your normal heart rate.
- Do not talk, yawn, or breathe deeply while taking heart rate measurements. Doing so may cause your heart rate to be recorded inaccurately.

- Heart rate measurements may vary depending on the measurement method and the environment they are taken in.
- If the sensor is not working, check the Watch's position on your wrist and make sure nothing is obstructing the sensor. If the sensor continues to have the same problem, visit a Samsung Service Centre or an authorised service centre.

### Measuring your heart rate manually

- 1 Tap  (Samsung Health) on the Apps screen.
- 2 Tap **Heart rate**.
- 3 Tap **Measure** to begin measuring your heart rate.  
Check the measured heart rate on the screen.



To check additional information which is related to the heart rate, use the bezel or swipe upwards or downwards on the screen.

### Changing the heart rate measurement settings

- 1 Tap  (Samsung Health) on the Apps screen.
- 2 Tap **Heart rate**.
- 3 Tap **Settings** and select the measurement method under **Measurement**.
  - **Measure continuously**: Your heart rate will be measured continuously.
  - **Every 10 mins while still**: Your heart rate will be measured every 10 minutes while resting.
  - **Manual only**: Your heart rate will be measured manually only when tapping **Measure**.

## Setting the heart rate alert

You can receive an alert when your heart rate is higher or lower than the resting heart rate value you set and it lasts more than 10 minutes.

- 1 Tap  (**Samsung Health**) on the Apps screen.
- 2 Tap **Heart rate**.
- 3 Tap **Settings** and set the alert under **Heart rate alert**.
  - **High HR:** Set to receive an alert when your heart rate is consistently higher than the heart rate value you set.
  - **Low HR:** Set to receive an alert when your heart rate is consistently lower than the heart rate value you set.

## Stress

Check your stress level by utilising the bio data collected by your Watch and reduce your stress by following the breathing exercise that the Watch provides.

-  • The more frequently you measure your stress level, the more accurate your results will be because of the accumulated data.
- Your measured stress level is not necessarily related to your emotional state.
- Your stress level may not be measured, while you are sleeping, working out, moving a lot, or right after you finish a workout.
- For accurate measurements, wear the Watch firmly around your lower arm above the wrist. Refer to [How to wear the Watch for accurate measurements](#) for more information.
- This feature may not be available depending on the region.





## Measuring your stress level manually

- 1 Tap  (**Samsung Health**) on the Apps screen.
- 2 Tap **Stress**.

- 3 Tap **Measure** to begin measuring your stress level.  
Check the measured stress level on the screen.



## Alleviating stress with the breathing exercise

- 1 Tap  (Samsung Health) on the Apps screen.
- 2 Tap **Stress**.
- 3 Tap  or  under **Breathe** to change the time and the number for the breath exercise. To change the breath exercise duration, tap **Breathe duration**.
- 4 Tap **Start** and start breathing.  
To stop the breathing exercise, tap the screen and tap .



## Changing the stress measurement settings

- 1 Tap  (Samsung Health) on the Apps screen.
- 2 Tap **Stress**.
- 3 Tap **Settings** and select the measurement method under **Measurement**.
  - **Measure continuously**: Your stress level will be measured continuously.
  - **Manual only**: Your stress level will be measured manually only when tapping **Measure**.



## Body composition

Measure your body composition, such as your skeletal muscle mass or fat mass.

-  • This feature is only for your general wellness and fitness. Therefore, do not use it for medical purposes, such as diagnosing the symptoms, treatment, or prevention of disease.
- Do not measure your body composition if you have an implanted cardiac pacemaker, defibrillator, or if any other electronic device is inside of your body.
- A low electric current goes through your body when measuring your body composition. Although it is harmless to humans, do not measure your body composition if you are pregnant.
-  • For accurate measurements, wear the Watch firmly around your lower arm above the wrist. Refer to [How to wear the Watch for accurate measurements](#) for more information.
- For accurate body composition measurements, you must enter your actual height, weight, and gender on the Samsung Health app profile of the connected phone, and also enter your actual birthday on your Samsung account. If the measured body composition results are inaccurate, check your user profile in the Samsung Health app on the phone and modify it.
- Unlike professional body composition measuring instruments, the Watch, which has to be worn your wrist, measures the upper body's composition and estimates your entire body's composition to provide the results. Therefore the measured body composition results may be inaccurate in the following cases: when your upper and lower body's composition is too unbalanced, when you are extremely obese, or when you have a very large amount of muscles.



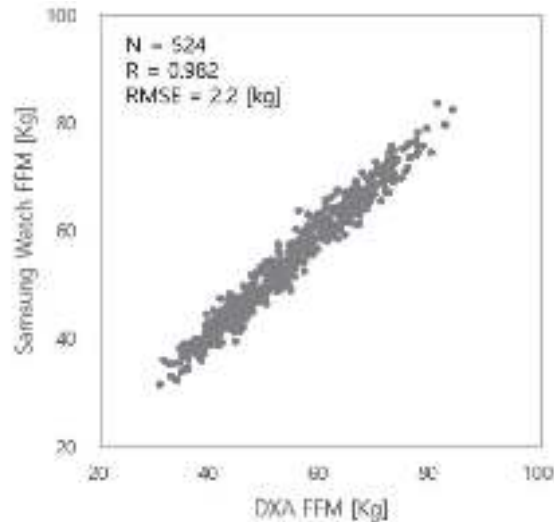

- The Watch uses the Bioelectrical Impedance Analysis (BIA) method when measuring body composition, which has more than 98% correlation compared to the Dual-energy X-ray absorptiometry (DXA) method, which is regarded as the golden standard.



**Be aware of following conditions before measuring your body composition:**

- If you are an individual under the age of 20, the results may not be accurate when you measure your body composition.
- You can get more accurate body composition results if you follow the following measurement conditions:
  - Measuring at the same time of the day (recommended to measure in the morning)
  - Measuring on an empty stomach
  - Measuring after going to the bathroom
  - Measuring when you are not having your menstrual period
  - Measuring before doing activities that cause your body temperature to rise, such as exercising, taking showers, or going to the sauna.
  - Measuring after removing metal objects from your body, such as necklace
  - Using the band included with the Watch instead of a metallic band

## Measuring your body composition

- 1 Tap  (**Samsung Health**) on the Apps screen.
  - 2 Tap **Body composition**.
  - 3 Tap **Measure**.
-  You can learn about how to measure your body composition in detail on the screen by tapping **How to measure**.
- 4 Enter your weight and tap **Confirm**.
  - 5 Place your two fingers on the Home and Back buttons by following the on-screen instructions to begin measuring your body composition.

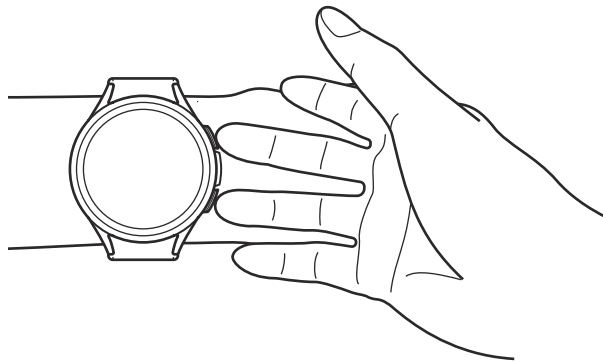

Correct position for measuring your body composition when wearing the Watch on your left wrist while the buttons are located on the right side

### **Correct measurement posture**

- Put both of your arms to chest level while not making contact with your body.
- Ensure that the two fingers placed on the Home and Back buttons do not come into contact with each other. Also, do not touch the other parts of your Watch except the buttons.
- Stay stable and do not move for accurate measurement results.
- The signal may experience interruptions when your finger is dry. In this case, measure your body composition after applying toner or lotion to make your finger's skin moist.
- Measurement results may not be accurate because of the dryness of your skin or hair.
- Wipe the back of the Watch clean before measuring for accurate measurement results.

Check measured body composition results on the screen.



To check the additional information which is related to the body composition, use the bezel or swipe upwards or downwards on the screen.

## Cycle tracking

Enter your menstrual period to begin tracking your cycle. When you are managing and tracking your menstrual cycle, you can predict date like your next period.

- ⚠️ • This feature is only for managing and tracking your menstrual cycle. Therefore, do not use it for medical purposes, such as diagnosing the symptoms, treatment, or prevention of disease.
- This feature is not intended to be used for pregnancy planning or contraception purposes.
- Predicted dates are only for personal reference. Predicted dates may differ from actual dates.
- Individuals under the age of 18 should use this feature with a guardian.
- Do not make any medical decisions based on predicted dates without consulting a physician. Also, do not use the information provided by the Samsung Health app or take medical actions without consulting with a qualified medical expert.
- 📝 • Turn on the cycle tracking feature in the Samsung Health app on your phone to use this feature on your Watch.
- Predicted dates may vary depending on the input information.

1 Tap  (Samsung Health) on the Apps screen.

2 Tap **Cycle tracking**.

- 3 Tap **Enter period**.
- 4 Tap the input field, use the bezel or swipe upwards or downwards on the screen to set your period's start date.
- 5 Tap **Save**.

To check additional information which is related to your cycle tracking, use the bezel or swipe upwards or downwards on the screen.



## Predicting your menstrual cycle by measuring your skin temperature

- 1 Tap  (**Samsung Health**) on the Apps screen.
- 2 Tap **Settings**.
- 3 Tap the **Predict period with skin temp** switch to turn it on.

## Water

Record and track how many glasses of water you drink.

### Recording water consumption

- 1 Tap  (**Samsung Health**) on the Apps screen.
- 2 Tap **Water**.
- 3 Tap  when you drink a glass of water.  
If you accidentally added an incorrect value, you can fix it by tapping .

### Setting your target consumption

- 1 Tap  (**Samsung Health**) on the Apps screen.
- 2 Tap **Water** and tap **Set target**.
- 3 Use the bezel or swipe upwards or downwards on the screen to set the daily target.
- 4 Tap **Done**.

## Blood oxygen

Measure your blood's oxygen level to check whether your blood is properly delivering oxygen to the different parts of your body.

 This feature is only for your general wellness and fitness. Therefore, do not use it for medical purposes, such as diagnosing the symptoms, treatment, or prevention of disease.

### **Be aware of following conditions before measuring your blood oxygen level:**

- Rest for five minutes before taking measurements.
- During winter or in cold weather, keep yourself warm when measuring your blood oxygen level.
- Blood oxygen level measurements may vary depending on the measurement method and the environment they are taken in.

### **Measuring your blood oxygen level manually**

- 1 Tap  (Samsung Health) on the Apps screen.
- 2 Tap **Blood oxygen**.

3 Tap **Measure** to begin measuring your blood oxygen level.

 **Correct measurement posture**

- For accurate measurements, wear the Watch firmly around your lower arm above the wrist while leaving two fingers' worth of space as shown in the figure. Also, place your elbow on the table while positioning your wrist close to your heart.

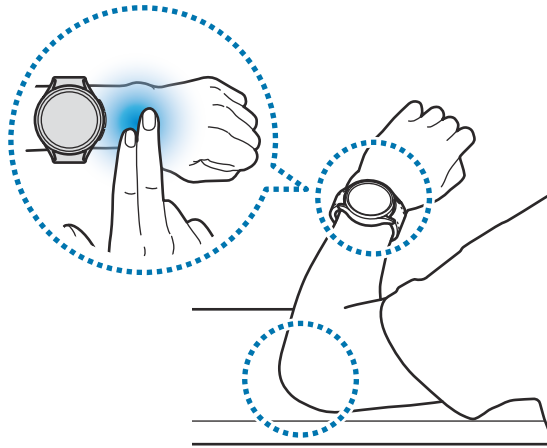

- Do not move and stay in the correct posture until finishing the measurement.
- You can learn about how to measure your blood oxygen level in detail on the screen by tapping **How to measure**.

Check the measured blood oxygen level on the screen. If your resting blood oxygen level is between 95% and 100%, it is assumed to be within the normal range.



## Measuring your blood oxygen level while sleeping

Set to measure your blood oxygen level continuously while sleeping.

1 Tap  (**Samsung Health**) on the Apps screen.

2 Tap **Settings**.

3 Tap the **Blood oxygen during sleep** switch to turn it on.

Your sleeping blood oxygen level will be measured along with your other sleep records when you sleep while wearing the Watch.

-  • If your blood oxygen level is measured continuously while sleeping, the battery will drain more quickly than normal.
- You can see the light because of the flickering optical heart rate sensor while measuring your blood oxygen level.
- The Watch may measure your blood oxygen level even if you are not sleeping because your Watch can recognise your sleep status even while reading books or watching TVs or movies.
- Wear the Watch firmly to ensure that you will not create space between your wrist and the Watch when turning over in your sleep.

## Together

Compare your step count records with your friends who also use the together feature of the Samsung Health app. When you start step challenges with your friends, you can check the challenge status on your Watch.

1 Tap  (**Samsung Health**) on the Apps screen.

2 Tap **Together**.

Tap **Show on phone** to check detailed information which is related to the together feature on your connected phone.

-  Turn on the together feature in the Samsung Health app on your phone to check the together information on your Watch.



## Settings

You can set the various setting options related to exercise and fitness.

Tap  (**Samsung Health**) on the Apps screen and tap **Settings**.

- **Measurement:** Set how to measure your heart rate and stress, and turn the additional features that can be measured during sleep on or off.
- **Labs:** Use new features of the Watch.
- **Auto detect workouts:** Turn on the auto detect feature and configure the settings, such as selecting the exercise types to be detected.
- **Inactive time:** Turn the feature on to receive alerts after 50 minutes of inactivity, and set the time and days you want to be notified.
- **Make visible to other devices:** Allow other devices to find your Watch.
- **Share data with devices and services:** Set to share information with other connected health platform apps, exercise machines, and TVs.
- **Privacy:** Select apps or service providers to share information with to display the necessary information during exercise.



Some features may not be available depending on the region, carrier, or model.

# Samsung Health Monitor

## Introduction

You can measure your blood pressure or ECG whenever you want to check them with the Samsung Health Monitor app of your Watch that includes both the optical heart rate sensor and electrical biosensor. You can check the measurement history using the Samsung Health Monitor app on your connected phone since your Watch and phone have been synced automatically.

Manage your health more systemically with your physician based on your measurement results.



- If you have not installed the Samsung Health Monitor app on your connected phone, open the **Samsung Health Monitor** app on your Watch and follow the on-screen instructions to download it from the **Galaxy Store** on the phone.
- The Samsung Health Monitor app is only supported on Samsung phones.
- Individuals under the age of 22 cannot use the Samsung Health Monitor app to measure your blood pressure or take your ECG.
- This app may not be available depending on the region.

## Precautions for measuring blood pressure and ECG



### Common precautions

- The Samsung Health Monitor app cannot be used for medical purposes, such as diagnosing hypertension, cardiac disorders, and other heart conditions. Do not use this app for purpose of replacing a physician's medical judgment or treatment under any circumstances. In case of an emergency, contact a nearby hospital immediately.
- Do not change your medication, dosage, or usage without your physician's advice.
- The readings and results from the Samsung Health Monitor app are only for reference. Do not use them for making medical decisions without your physician's opinion under any circumstances.
- For accurate measurements, wear the Watch firmly around your lower arm above the wrist. Refer to [How to wear the Watch for accurate measurements](#) for more information.



- Before measuring your blood pressure or ECG, prepare a comfortable chair and a table to rest your arm and phone on.
- Sit upright in the comfortable chair you prepared with your back supported.
- Be sure to place your arm comfortably on a table when you are measuring your blood pressure or taking an ECG.
- Rest for at least five minutes in a comfortable position before measuring your blood pressure or taking your ECG.
- Measure your blood pressure or ECG in a quiet place indoors.
- Do not measure your blood pressure or ECG while engaging in physical activity.
- Stay still and do not speak once you start measuring your blood pressure or taking your ECG, and do not move or speak until the measurement is complete.
- Do not measure your blood pressure or take your ECG when you are in close vicinity of machines that produce strong electronic fields, such as MRIs (Magnetic Resonance Imaging), X-ray machines, electromagnetic anti-theft systems, or metal detectors.
- Always connect your Watch to your phone at home or in a safe place through Bluetooth for security reasons. It is not recommended to connect to a phone in a public place.
- Do not measure your blood pressure or take your ECG during medical treatments, such as operations or defibrillation.
- Measure your blood pressure or ECG in an environment where the temperature is between 12°C to 40°C, and the relative humidity is between 30% to 90%.

### **Precautions for measuring the blood pressure**

- Avoid consuming alcohol, food that includes caffeine, smoking, exercising, and taking a bath 30 minutes before measuring your blood pressure.
- Make sure your wrist is dry when measuring your blood pressure and do not measure it when you have applied lotion or are sweating excessively.
- Do not take a deep breath or breathe slowly on purpose, but breath as usual while measuring your blood pressure.
- If you are pregnant, your results may not be accurate when you measure your blood pressure.
- Do not measure your blood pressure with the Samsung Health Monitor app if you have any of the following conditions:
  - Arrhythmia
  - Underlying heart disease or have suffered a heart attack
  - Circulatory or peripheral vascular disease
  - Valvular heart disease (Aortic valve disease)
  - Myocardopathy
  - Other cardiovascular disease
  - End-stage renal disease (ESRD)
  - Diabetes
  - Neurological dysfunction (for example, tremors)
  - Blood clotting dysfunction or if you are taking a blood thinner
- Do not use a wrist that has been tattooed or has marks on it when measuring your blood pressure because the optical heart rate sensor may be affected by the tattoos or marks.



- The Samsung Health Monitor app calibrates and measures blood pressure based on the readings from the arm that is wearing the blood pressure manometer. You must consult your physician if there is a large difference between the blood pressure in both of your arms (more than 10 mmHg).
- Do not use a Watch which has been calibrated for other people for measuring your blood pressure.
- The measurable reading range of the Samsung Health Monitor app for blood pressure is as follows: In case of calibration, the systolic blood pressure range is 80 mmHg to 170 mmHg, and the diastolic blood pressure is 50 mmHg to 110 mmHg. In case of measurement, the systolic blood pressure range is 70 mmHg to 180 mmHg, and the diastolic blood pressure is 40 mmHg to 120 mmHg.
- The signal may be affected by the brightness of the individual's skin, the amount of blood under their skin, and the cleanliness of the sensor.



### **Precautions for measuring the ECG**

- Make sure your wrist is not too dry when measuring your ECG. You can get more accurate ECG signals when your skin that comes in contact with the sensor is moist with a moderate amount of sweat, toner, or lotion.
- Do not measure your ECG if you have an implanted cardiac pacemaker, defibrillator, or if any other electronic device is inside of your body.
- Do not take your ECG with the Samsung Health Monitor app if you have an arrhythmia other than atrial fibrillation.
- The Samsung Health Monitor app cannot detect heart attacks. If you have any suspicious symptoms of a heart attack, contact emergency services immediately.
- You can get more accurate ECG results if you follow the following measurement conditions:
  - Measuring after removing metal objects from your body, such as necklace
  - Using the band included with the Watch instead of a metallic band

## Starting to measure the blood pressure

### Presetting before measuring the blood pressure

Enter your profile on the Samsung Health Monitor app and calibrate your Watch before measuring your blood pressure. If you do not enter a profile, you cannot measure your blood pressure, and if you do not calibrate the Watch or have someone else calibrate it, the readings will not be valid.

 Be sure to calibrate the Watch with cuff-typed blood pressure manometer when measuring your blood pressure with the Samsung Health Monitor app for the first time after purchasing the Watch. After initial calibration, recalibrate it every 28 days. The cuff-typed blood pressure manometer is sold separately.

- 1 Tap  (**Samsung Health Monitor**) on the Apps screen.
- 2 Tap **Blood pressure** → **Open phone app**.  
The Samsung Health Monitor app will open on your phone.
- 3 Tap **Accept**.
- 4 Enter your profile information, such as your name, gender, and birthday, and tap **Continue**.
- 5 Tap **Calibrate the watch**.
- 6 Wear the cuff of the blood pressure manometer on the upper part of the arm not wearing the Watch. Refer to the blood pressure manometer's user manual for more information about correctly wearing the cuff.
- 7 Follow the on-screen instructions to complete the calibration.

## Measuring your blood pressure

You can measure your blood pressure by using your Watch's optical heart rate sensor without using any other medical devices, such as the cuff-typed blood pressure manometer, after calibration.

 You have to wear your Watch on the same wrist used for calibration.

1 Tap  (**Samsung Health Monitor**) on the Apps screen.

2 Tap **Blood pressure** → **Measure**.

Check the measured systolic and diastolic blood pressure and pulse rate on the screen.



## Checking the readings

Check the readings on the Watch's screen after measuring your blood pressure. You can check the previous readings and information on the connected phone's Samsung Health Monitor app. Share, delete, and manage your results on the phone's Samsung Health Monitor app.

If your readings are abnormally high or low and feel some unusual physical symptoms, contact a nearby hospital immediately for proper medical attention. Measure at least 2 more times again if you are judged not to be in an emergency.

## Starting to measure the ECG

### Presetting before measuring the ECG

Enter your profile on the Samsung Health Monitor app before measuring your ECG. If you do not enter a profile, you cannot measure your ECG.

- 1 Tap  (**Samsung Health Monitor**) on the Apps screen.
- 2 Tap **ECG** → **Open phone app**.  
The Samsung Health Monitor app will open on your phone.
- 3 Tap **Accept**.
- 4 Enter your profile information, such as your name, gender, and birthday, and tap **Continue**.
- 5 Tap **Get started** and follow the on-screen instructions to get ready for measuring your ECG.

### Measuring the ECG

Manage your health by checking your heart status in advance through the ECG measurement results.

- 1 Tap  (**Samsung Health Monitor**) on the Apps screen.
- 2 Tap **ECG** → **OK** and place a finger lightly on the electrical biosensor. Do not leave any space between your wrist and your Watch.

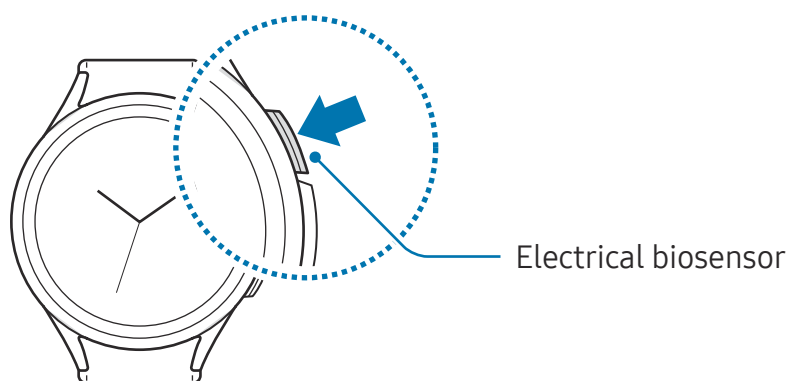



The measurement will start and the ECG wave will appear on the screen.

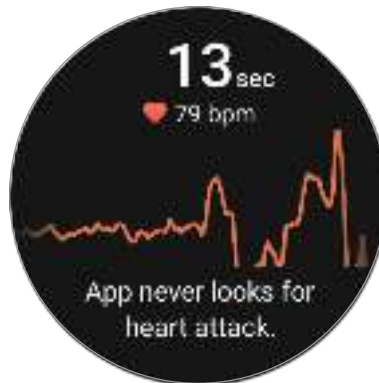

Check the measured ECG results on the screen.



- 3 Tap **Add**, select additional physical symptoms that you are currently experiencing, and then tap **Save**.
- 4 Tap **Done**.

## Checking the results

Check the results and ECG wave on the Watch and the connected phone's Samsung Health Monitor app screen after taking your ECG. The ECG wave shows heart rate rhythm and electric activities of your heart, and it is divided into several parts. Share the ECG graph and results with your physician to get an accurate diagnosis through a more thorough checkup when you find abnormal results from your ECG wave and readings.

You can check the previous results and information on the connected phone's Samsung Health Monitor app. Share, delete, and manage your results on the phone's Samsung Health Monitor app.

- **Sinus rhythm**: A normal heartbeat rhythm that is between 50 - 100 BPM.
- **AFib**: A type of arrhythmia where the heart beats irregularly. Consult your physician.
- **Inconclusive**: The result is not a type of **Sinus rhythm** nor **AFib** and falls into one of the following conditions:
  - When the heart rate is less than 50 or more than 100 BPM while recording the ECG wave and there is also no **AFib**
  - When the ECG wave is not sorted as **Sinus rhythm** nor **AFib**
  - When the heart rate is more than 120 BPM and the ECG wave indicates **AFib**

- **Poor recording:** It appears when the signals used for analysing the ECG measurement result are not measured properly. If this case, take the measurement again.
-  Contact your physician or a nearby hospital immediately if **Inconclusive** or **Poor recording** appears continuously and you feel some unusual physical symptoms.
-  • If **Poor recording** appears continuously, wipe out the electrical biosensor and measure your ECG again. The signal may be experiencing interruptions because of the dryness of the skin on the sensor or hair on your wrist. In this case, measure your ECG after applying toner or lotion to make your skin moist or after removing some hair first.
- If the ECG wave appears upside down, it may not be analysing your ECG properly. Tap  (**Settings**) on the Apps screen and tap **General** → **Orientation** to check the settings on the wrist where you wear it and the buttons' location. Then, wear your Watch in the correct direction and measure your ECG again.

## GPS

The Watch has a GPS antenna so that you can check your real-time location information without connecting to a phone.

On the Apps screen, tap  (**Settings**) → **Location** and tap the switch to turn it on.

-  • When your Watch and phone are connected, this feature uses your phone's GPS. Turn on the phone's location feature to use the GPS sensor.
- The GPS antenna in your Watch will be used when using the Samsung Health feature and the health platform apps, even though your Watch is connected to your phone.
  - GPS signal strength may decrease in locations where the signal is obstructed, such as between buildings or in low-lying areas, or in poor weather conditions.

# Music

## Introduction

Listen to music saved on your Watch.

## Using Music

Tap  (**Music**) on the Apps screen.

Drag the  icon upwards and tap **Library** to open the Library screen. On the Library screen, you can check the playlist and arrange music by tracks, albums, and artists.

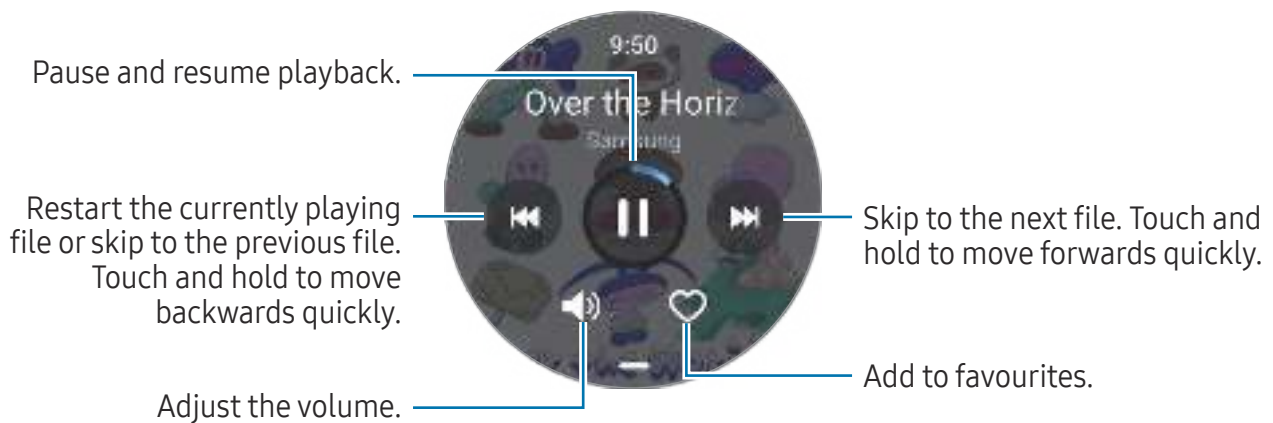

## Managing audio files saved on your Watch

Check the audio files on your Watch, categorised by type, and manage them by adding or removing them as desired.

- 1 Open the **Galaxy Wearable** app on your phone.
- 2 Tap **Watch settings** → **Manage content**.

### 3 Select **Tracks on watch**.

The audio files saved on your Watch will appear, sorted by category.



- To send audio files from your phone to your Watch, tap **+**, select audio files, and then tap **Add to watch**.
- To delete audio files saved on your Watch, touch and hold a file you want to delete, and tap **Delete**.

To sync audio files on your phone with your Watch every 6 hours, tap the **Auto sync** switch under **Music** to turn it on. Then, tap **Playlists to sync**, select playlists to import to your Watch, and then tap **Done**. The selected playlists will be automatically synced with your Watch when it has more than 15% of remaining battery power and when power saving mode is turned off on your Watch.

## Media Controller

### Introduction

Control the media app installed on your Watch or the connected phone to play or pause music and video.

-  To open this app automatically from your Watch when you play music or videos on the connected phone, on the Apps screen, tap  (**Settings**) → **Display** and tap the **Show media controls** switch to turn it on.

### Controlling the music player

- 1 Tap  (**Media Controller**) on the Apps screen.

## 2 Select **Phone** or **Watch**.

When you select **Phone**, music will play from the connected phone's music app and you can control the music player with your Watch.

When you select **Watch**, music will play from your Watch's music app and you can listen to music with your Watch's speaker or a connected Bluetooth headset.

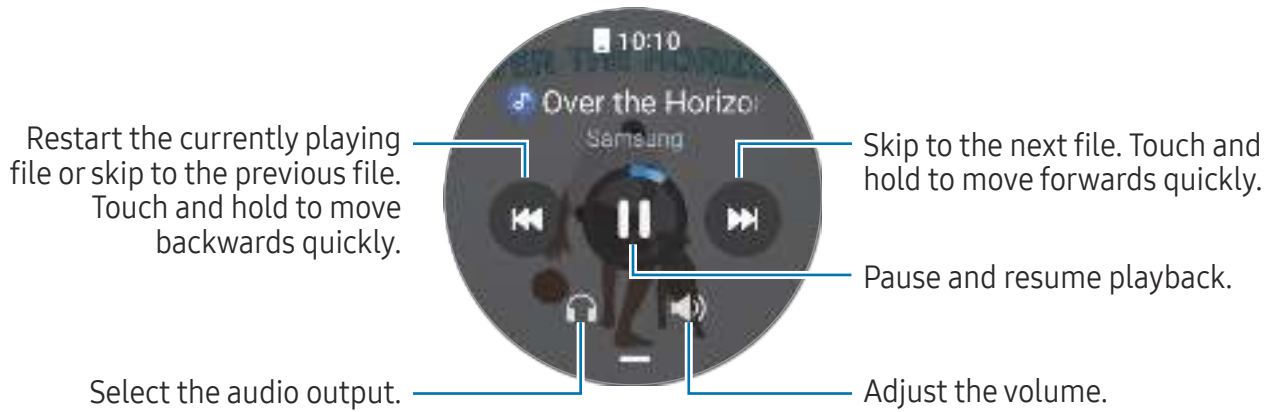



## Controlling the video player

- 1 Play video on the connected phone.
- 2 Tap  (**Media Controller**) on the Apps screen.
- 3 Tap **Phone**.  
You can control the video player with your Watch.

## Reminder

Register to-do items as reminders and receive notifications according to the condition you set.

-  • To receive reminder notifications in a specific place, you have to connect your Watch to your phone through Bluetooth. However, the feature for setting you to receive reminder notifications in a specific place is only available on your phone.
- All reminders on your Watch will be synced with the connected phone automatically so that you can also receive alerts and check them from the phone.

- 1 Tap  (**Reminder**) on the Apps screen and tap **Write**.  
If you have a saved reminder, tap  on the top of the reminders list.
- 2 Enter the reminder.
- 3 Tap **Set time** to set a notification.
- 4 Tap the input field, use the bezel, or swipe upwards or downwards on the screen to set the time, and tap **Next**.
- 5 Set other notification options, such as the date when to receive the notification and whether to repeat the notification, and tap **Done**.
- 6 Tap **Save**.  
The saved reminder is added to the reminders list and the reminder will appear at the time you set with an alarm.

### Completing reminders

On the reminders list, tap  or select a reminder and tap **Complete**.

### Restoring reminders

Restore reminders that have been completed.

- 1 On the reminders list, tap **Completed**.
- 2 Select a reminder to restore and tap **Restore**.  
Reminders will be added to the reminders list and you will be reminded again.

### Deleting reminders

Touch and hold the reminder on the reminder list, and then tap **Delete**.

## Calendar

You can check the 7-day schedules of events that you saved on your phone on your Watch.

Tap  (**Calendar**) on the Apps screen to check the schedules of events that you saved on your phone.

To add your schedule, tap **Show on phone** and add it on the connected phone.

## Bixby

Bixby is a user interface that helps you use your Watch more conveniently.

You can talk to Bixby. Bixby will launch a feature you request or show the information you want. Visit [www.samsung.com/bixby](http://www.samsung.com/bixby) for more information.

-  • Make sure the Watch's microphone is not obstructed when you are speaking into it.
- Bixby is only available in some languages, and certain features may not be available depending on your region.

### Starting Bixby

Press and hold the Home button to launch Bixby and complete the setup by following the on-screen instructions.

If you cannot launch Bixby with the Home button, on the Apps screen, tap  (**Settings**) → **Advanced features** → **Customise buttons**, tap **Press and hold** under **Home button**, and then select **Bixby**.

### Using Bixby



While pressing and holding the Home button, say what you want to Bixby. Alternatively, say the wake-up phrase after turning on the screen and say what you want.

For example, while pressing and holding the Home button, say “How’s the weather today?” The weather information will appear on the screen.

If Bixby asks you a question during a conversation, you can continue to talk to Bixby without pressing the Home button or .

## Waking up Bixby using your voice

You can start a conversation with Bixby by saying “Hi, Bixby” or “Bixby”.

- 1 Tap  (**Bixby**) on the Apps screen. Alternatively, press and hold the Home button.
- 2 Tap  → **Voice wake-up**.
- 3 Tap the **Wake with “Hi, Bixby”** switch to turn it on.
- 4 Tap **Wake-up phrase** and select a wake-up phrase you want.  
Now you can say the wake-up phrase and start a conversation.

## Weather

Check weather information on the Watch for locations set on the connected phone.

Tap  (**Weather**) on the Apps screen.

To check the weather information, such as the time-specific weather or weekly information, use the bezel or swipe upwards or downwards on the screen.

To add another city’s weather information, tap **Manage locations** → **Manage on phone** and add the city from the connected phone.

## Alarm

Set and manage the Watch’s alarms and the phone’s alarms individually.

-  When your Watch is connected to your phone through Bluetooth, you can check all alarm lists on your phone from the Watch.

## Setting alarms

- 1 Tap  (**Alarm**) on the Apps screen.
- 2 Tap **Add on watch** to set alarms that only go off on your Watch.  
You can also add an alarm from the connected phone by tapping **Add on phone**.
- 3 Tap the input field, use the bezel or swipe upwards or downwards on the screen to set the alarm time, and tap **Next**.



- 4 Set other alarm options, such as the date when to go off and whether to repeat the alarm, and tap **Save**.

The saved alarm is added to the alarms list.

To turn on or off alarms, tap the switch next to the alarm in the alarms list.

## Turning off alarms

Drag  outside the large circle to turn off an alarm. Alternatively, rotate or swipe the bezel clockwise.

If you want to use the snooze feature, drag  outside the large circle. Alternatively, rotate or swipe the bezel anticlockwise.

## Deleting alarms

In the alarms list, touch and hold an alarm, and then tap **Delete**.



## World Clock

Tap  (**World Clock**) on the Apps screen to check the world clocks added from the phone.

To add a world clock, tap **Add on phone**. Or, if you have added world clocks, tap **Manage on phone**, and then add or remove a world clock on the connected phone.

## Timer

### Setting a timer

- 1 Tap  (**Timer**) on the Apps screen.
- 2 Tap .
- 3 Tap the input field, use the bezel or swipe upwards or downwards on the screen to set the duration, and tap .





 If you select a preset, the timer will start right away. You can also check more presets by using the bezel or swiping upwards or downwards on the screen.

## Dismissing a timer

Drag  outside the large circle when your timer goes off. Alternatively, rotate or swipe the bezel clockwise.

To restart the timer, drag  outside the large circle. Alternatively, rotate or swipe the bezel anticlockwise.

## Stopwatch

- 1 Tap  (**Stopwatch**) on the Apps screen.
- 2 Select the stopwatch style you want by using the bezel or swiping left or right on the screen.  
To change the stopwatch style, touch and hold the screen.
- 3 Tap **Start** to time an event.  
To record lap times while timing an event, tap **Lap** or .
- 4 Tap **Stop** or  to stop timing.
  - To restart the timing, tap **Resume** or .
  - To clear lap times, tap **Reset** or .

## Gallery

### Introduction

You can access images, albums, and stories saved on your Watch or synced with your phone. Also, you can personalise the watch face by using pictures.

### Transferring pictures to your Watch

Transfer pictures from your phone to your Watch or sync them automatically.

- 1 Open the **Galaxy Wearable** app on your phone.
- 2 Tap **Watch settings** → **Manage content**.

3 Select **Add images**.

4 Select a picture to transfer to your Watch and tap **Done**.

To sync images on your phone with your Watch, tap the **Auto sync albums** switch under **Gallery** to turn it on. Then, tap **Albums to sync**, select albums to import to your Watch, and then tap **Done**. The selected albums will be automatically synced with your Watch when it has more than 15% of remaining battery power and when power saving mode is turned off on your Watch.

## Using Gallery

Tap  (**Gallery**) on the Apps screen.

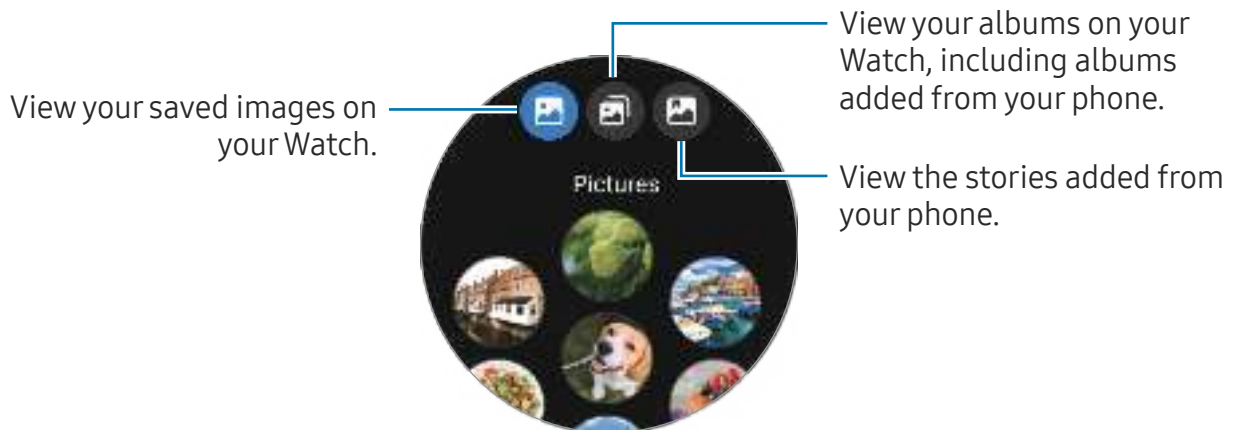

## Viewing images

Check and manage the images saved on your Watch.

1 Tap  (**Gallery**) on the Apps screen.

2 Select a category.

3 Use the bezel or swipe upwards or downwards on the screen to scroll through the list and select an image.



## Zooming in or out

While checking an image, double tap the image, spread your two fingers apart, or pinch on an image to zoom in or out.



When an image is magnified, you can view the rest of the image by scrolling around the screen.

## Customising a watch face

You can view pictures on your watch face after personalising it with pictures. Refer to [Customising a watch face with a picture](#) for more information.



- 1 Tap  (**Gallery**) on the Apps screen.
- 2 Touch and hold the image to use.
- 3 Use the bezel or swipe left or right on the screen and select more images.
- 4 Tap  and select a watch face type.

## Deleting images

- 1 Tap  (**Gallery**) on the Apps screen.
- 2 Touch and hold the image to delete it.
- 3 Use the bezel or swipe left or right on the screen and select any images to delete more.  
To select all images, tap **All**.
- 4 Tap .

## Find My Phone

If you misplace the phone, the Watch can help you find it.

- 1 Tap  (**Find My Phone**) on the Apps screen.
- 2 Tap **Start**.  
The phone will make a sound and vibrate, and its screen will turn on.  
To stop making sound and vibrating, tap  and drag it on the phone, or tap **Stop** on the Watch.

## Find My Watch

If you misplace your Watch, the Galaxy Wearable app on your connected phone or the SmartThings Find feature of the SmartThings app installed on your connected phone can help you find it.

-  • SmartThings Find feature support may vary depending on the software version of the connected phone.
- The screen may be switched automatically to find your Watch with the SmartThings Find feature if the connected phone supports the SmartThings Find feature.

### Finding with the Galaxy Wearable app

- 1 Open the **Galaxy Wearable** app on your phone and tap **Find My Watch**.
- 2 Tap **Start**.  
The Watch will make a sound and vibrate, and its screen will turn on.

To stop making sound and vibrating, drag  outside the large circle on the Watch. Alternatively, use the bezel. You can also stop it by tapping **Stop** on the phone.

### Controlling the Watch remotely

When your Watch is lost or stolen, open the **Galaxy Wearable** app on your phone, tap **Find My Watch** → **Set security**, and then control your Watch remotely.

### Finding with the SmartThings Find feature from the SmartThings app

Open the **Galaxy Wearable** app on your phone and tap **Find My Watch**.

The SmartThings Find screen that is available through the SmartThings app will appear on the phone and you can check your misplaced Watch's location on the map. Also, you can find it by following the sound emitted from your Watch.

# Sending an SOS

## Introduction

In an emergency, including when you are hurt from a fall, make an emergency call and send an SOS message that includes your location information to previously registered contacts. Also, you can set up your Watch to display your medical information on it after sending the SOS.

-  • If the GPS feature of your Watch is not turned on and it is needed to send your location information, it will be turned on automatically to determine your location.
- Your location information may not be sent depending on your region or situation.

## Entering medical information

Enter your medical information, such as your name and blood type. This information can be accessed directly on your Watch during an emergency.

- 1 Open the **Galaxy Wearable** app on your phone and tap **Watch settings** → **Safety and emergency**.
- 2 Tap **Medical info**, enter your information, and then tap **Save**.

When sending an SOS or sharing your emergency, the entered medical information will appear on your Watch's SOS screen.

## Sharing your emergency

### Registering emergency contacts

Add contacts who can help you when sharing an emergency.

- 1 Open the **Galaxy Wearable** app on your phone and tap **Watch settings** → **Safety and emergency**.
- 2 Tap **Emergency contacts**.
- 3 Tap **Add member** and select contacts you want from your existing contact, and then tap **Done**.

## Sharing emergency information

When sharing an emergency, a message that includes your location information and a low battery alert warning will be sent to your emergency contacts. Also, the SOS screen will appear on your Watch, which will provide medical information to anyone who finds you in an emergency so they can help you.



- 1 Tap  (**Settings**) on the Apps screen.
- 2 Tap **Safety and emergency** → **Emergency sharing**.
- 3 Tap **Start**.  
Your current location will be shared with your emergency contacts and the SOS screen will appear on your Watch.



## Requesting an SOS

### Setting the SOS request

- 1 Open the **Galaxy Wearable** app on your phone and tap **Watch settings** → **Safety and emergency**.
- 2 Tap **Emergency SOS**.
  - To select a contact to make an emergency call, tap **Emergency number to call** and select a contact or enter one manually.
  - To send an SOS message that includes your current location to emergency contacts, tap the **Share info with emergency contacts** switch to turn it on. Refer to [Registering emergency contacts](#) for more information about setting the emergency contacts to send a message.
  - Tap the **Countdown** switch to turn it on and set the desired time for automatically initiating an emergency call and sending an SOS message on the SOS request screen. If this feature is turned off, you will need to manually place an emergency call and send a message on the SOS request screen within a specific time. If not, your Watch will automatically cancel the SOS request.

## Sending an SOS request

- 1 In an emergency, press the Watch's Home button five times.
- 2 When vibrating, drag  outside the large circle. Alternatively, rotate or swipe the bezel anticlockwise.  
A call is automatically placed to your emergency contact.
- 3 When the call is completed and the vibration resumes, drag  outside the large circle. Alternatively, rotate or swipe the bezel anticlockwise.  
Your current location will be shared with your emergency contacts and the SOS screen will appear on your Watch.

-  • To not place a call or share your current location drag  outside the large circle on the SOS request screen. Alternatively, rotate or swipe the bezel clockwise.
- If the **Share info with emergency contacts** feature is turned off, a message that includes your current location will not be sent to emergency contacts.
- If the **Countdown** feature is turned on, the emergency call and SOS message will be sent automatically after the time you set has passed.

## Requesting an SOS when you are hurt from a fall

### Setting the SOS request when you are hurt from a fall

- 1 Open the **Galaxy Wearable** app on your phone and tap **Watch settings** → **Safety and emergency**.
- 2 Tap **Hard fall detection** and tap the switch to turn it on.
- 3 Tap **When to detect falls** and select the condition in which your Watch will detect the hurt from a fall.
  - To select a contact to make an emergency call, tap **Emergency number to call** and select a contact or enter one manually.
  - To send an SOS message that includes your current location to emergency contacts when you are hurt from a fall, tap the **Share info with emergency contacts** switch to turn it on. Refer to [Registering emergency contacts](#) for more information about setting the emergency contacts to send a message.



## Sending an SOS request when you are hurt from a fall

When a big impact occurs, the Watch will detect the hurt from a fall through your arm's movement and it will display the alert while vibrating and emitting sound.

If you do not respond within 60 seconds, the emergency call will be made and an SOS message will be sent out automatically to the previously registered contacts after the countdown.

-  • The Watch may believe that you have been hurt in a fall if you are doing a high impact exercise. If it is so, cancel the alert not to send the SOS message.
- If the **Share info with emergency contacts** feature is turned off, a message that includes your current location will not be sent to emergency contacts.
- If you want to cancel the SOS request or manually place an emergency call and send the SOS message after a hard fall, open the **Galaxy Wearable** app on your phone, tap **Watch settings** → **Safety and emergency** → **Hard fall detection**, and then tap the **Countdown** switch to turn it off.

## Stop sharing the location information

While sharing your location information, the  icon appears on the Watch screen, and you can check the sharing status on the notification panel.



To stop sharing your location information, tap the notification panel and tap **Stop sharing** → .

-  If you do not stop sending SOS messages, additional messages that include your location information will be continuously sent to the previously registered contacts every 15 minutes for 24 hours after the first SOS message is sent. However, the message will be sent only when your current location is some distance away from the location where the last message is sent.

## Voice Recorder

Record or play voice recordings.

### Making voice recordings

- 1 Tap  (**Voice Recorder**) on the Apps screen.
- 2 Tap  to start recording. Speak into the Watch's microphone.  
To pause recording, tap .

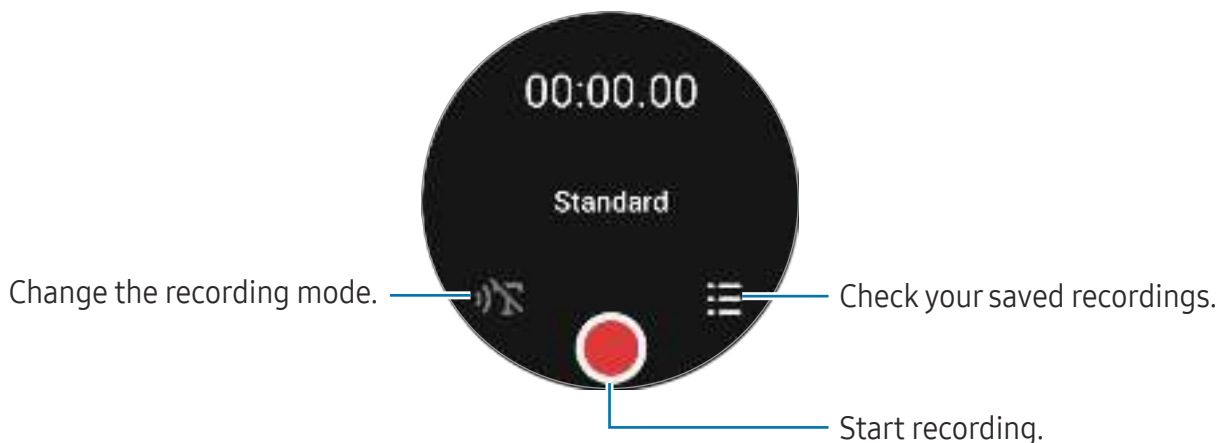



- 3 Tap  to finish recording.  
The recording will be saved. To listen to the recorded sound, select a recording file.

### Changing the recording mode

Tap  (**Voice Recorder**) on the Apps screen.

Select a mode you want.

- : This is the normal recording mode.
  - : The Watch records your voice for up to 10 minutes, converts it to text, and then saves it. For best results, keep the Watch near your mouth and speak loudly and clearly in a quiet place.
-  If the speech-to-text language does not match the language you are speaking, the Watch will not recognise your voice. Before using this feature, tap **Speech-to-text** to set the speech-to-text language.

## Calculator

You can perform calculations.



Tap  (**Calculator**) on the Apps screen.

Tap  and check the calculation history. To clear the history, tap **Clear history**.

Drag the  icon upwards to calculate a tip or use the unit conversion tool.

## Compass

You can use your Watch as a compass.

- 1 Tap  (**Compass**) on the Apps screen.
- 2 Drag the  icon upwards and tap **Calibrate** to calibrate the compass by swinging the wrist you are wearing the Watch on.  
After calibrating, the compass will appear.

Drag the  icon upwards to check additional information, such as the incline, altitude, and atmospheric pressure.

-  • The presence of magnetic substances, such as the wireless charger, may affect your Watch's internal compass sensor and lower its accuracy. Also, the metallic band, which contains magnetic substances, may affect your Watch's internal compass sensor by magnetic flux, depending on how you wear the band.
- The compass sensor may be affected by magnetic interference, leading to a decrease in accuracy, even if the compass was calibrated in a densely built-up city, inside a building, or in a confined indoor space like an indoor parking lot or inside of a car.





## Buds Controller

You can check the battery status of the Galaxy Buds connected to the Watch and change their settings.

Tap  (**Buds Controller**) on the Apps screen.

## Camera Controller

You can remotely control the cameras of the phone connected to the Watch and take pictures or record videos from a distance.

- 1 Tap  (**Camera Controller**) on the Apps screen.  
The Camera app will be opened on the connected phone.
- 2 Check the preview screen, and tap  to take a picture or tap  to record a video.  
To change the shooting mode, tap  or .

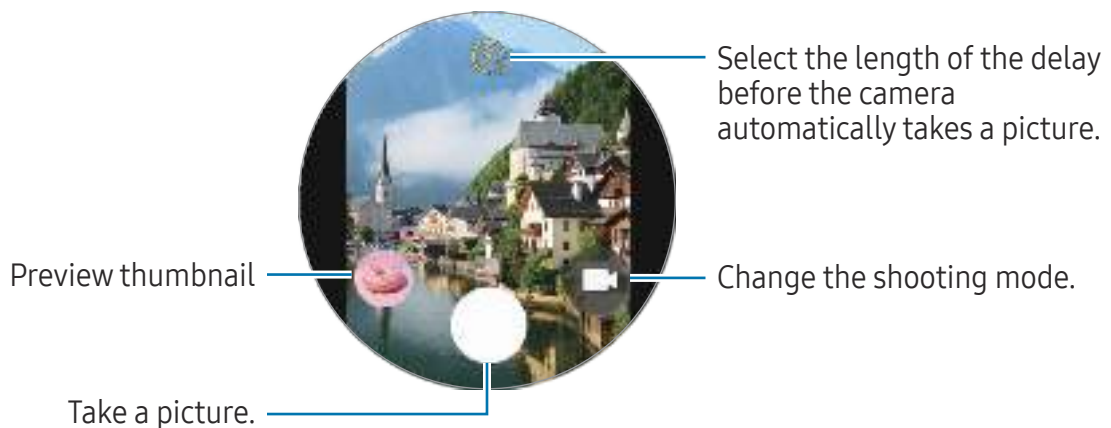

 This app may not be available depending on the connected phone.

## Samsung Global Goals

The Global Goals, which were established by the United Nations General Assembly in 2015, consist of goals that aim to create a sustainable society. These goals have the power to end poverty, fight inequality, and stop climate change.

With Samsung Global Goals, learn more about the global goals and join the movement for a better future.

## SmartThings

You can control smart appliances and Internet of Things (IoT) products that are connected to your phone with your Watch.

- 1 Tap  (**SmartThings**) on the Apps screen.
- 2 Select a device or scene to control.

To add the scenes or devices, tap **Show on phone** and add them on the connected phone.

 If you have not installed the SmartThings app on your connected phone or if the versions of the SmartThings app on your Watch and phone do not match, you will not be able to use this app. Tap **Show on phone** to download the latest version of the app on your phone.

## Google apps

Google provides some apps for Watch. You may require a Google Account to access some apps.

- **Maps:** Find your location on the map and search the map using GPS.
- **Messages:** Send and receive messages on your Watch or phone.

 Some apps may not be available depending on the carrier or model.

# Settings

## Introduction

Customise settings for functions and apps. Set your Watch depending on your usage pattern by configuring the various settings.

Tap  (**Settings**) on the Apps screen.

 Some features in Settings may not be available depending on the region, carrier, or model.

## Samsung account

Register the Samsung account on your connected phone or check the previously registered Samsung account.

On the Settings screen, tap **Samsung account**.

## Connections

### Bluetooth

Connect to a phone through Bluetooth. You can also connect other Bluetooth-enabled devices, such as a Bluetooth headset or computer.

On the Settings screen, tap **Connections** → **Bluetooth**.

### Precautions for using Bluetooth

- Samsung is not responsible for the loss, interception, or misuse of data sent or received through Bluetooth.
- Always ensure that you share and receive data with devices that are trusted and properly secured. If there are obstacles between the devices, the operating distance may be reduced.
- Some devices, especially those that are not tested or approved by the Bluetooth SIG, may be incompatible with your device.
- Do not use the Bluetooth feature for illegal purposes (for example, pirating copies of files or illegally tapping communications for commercial purposes). Samsung is not responsible for the repercussion of illegal use of the Bluetooth feature.

## Wi-Fi

Turn on the Wi-Fi feature to connect to a Wi-Fi network.

1 On the Settings screen, tap **Connections** → **Wi-Fi**, and tap the switch to turn it on.

2 Select a network from the Wi-Fi network list.

Networks that require a password appear with a lock icon.

3 Tap **Connect**.



- If you cannot connect to a Wi-Fi network properly, restart your Watch's Wi-Fi feature or the wireless router.
- The device is restricted to indoor use only when operating in the 5150–5350 MHz frequency range.

## NFC and contactless payments

You can use this feature to make payments and buy tickets for transportation or events after downloading the required apps.

On the Settings screen, tap **Connections** → **NFC and contactless payments**.



- The Watch contains a built-in NFC antenna. Handle the Watch carefully to avoid damaging the NFC antenna.

### Making payments with the NFC feature

Before you can use the NFC feature to make payments, you must register for the mobile payment service. To register or get more information about the service, contact your service provider.

1 On the Settings screen, tap **Connections** → **NFC and contactless payments** and tap the switch to turn it on.

2 Touch the NFC antenna area of the Watch to the NFC card reader.

To set the default app, on the Settings screen, tap **Connections** → **NFC and contactless payments** → **Payment** and select an app.

 The payment services list may not include all available payment apps.

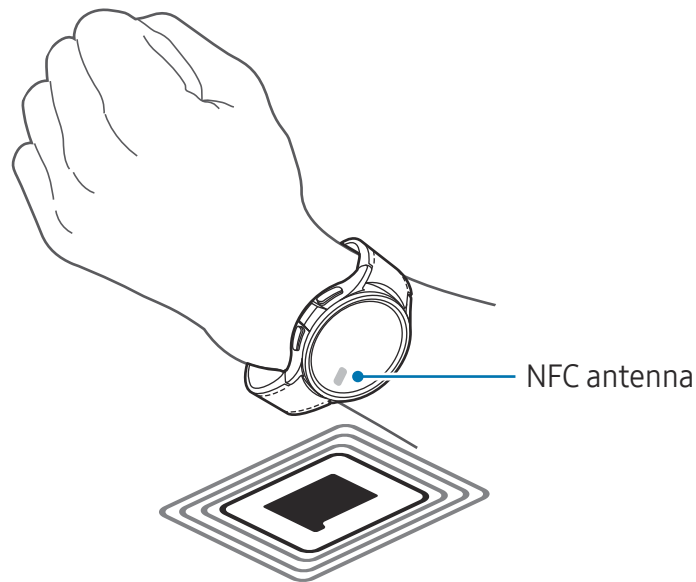

## Flight mode

Set the Watch to turn off all wireless functions on your Watch. You can use only non-network services.

On the Settings screen, tap **Connections** and tap the **Flight mode** switch to turn it on.



 Follow the regulations provided by the airline and the instructions of aircraft personnel. In cases where it is allowed to use the device, always use it in flight mode.



## Mobile networks (SM-R935F, SM-R945F, SM-R955F, SM-R965F)

Customise the settings to control mobile networks.

On the Settings screen, tap **Connections** → **Mobile networks** and select a mobile network connection option.

- **Auto:** Set to automatically use the Watch's mobile network when the Bluetooth connection with your phone is disconnected.
  -  • When the Watch is connected to the phone through Bluetooth, the Watch's mobile network is turned off to save battery power. Then, you cannot receive messages and calls made to the Watch's number.
  - When the Bluetooth connection with your phone is disconnected, the Watch's mobile network will automatically connect. Then, you can receive messages and calls made to the Watch's number.
- **Always on:** Set to always use the Watch's mobile network regardless of the connection with the phone.
- **Always off:** Set not to use the Watch's mobile network.
- **Mobile plans:** Subscribe to the carrier's mobile plan or additional services.
  -  • Some services that require a network connection may not be available depending on the carrier.
  - When you are not subscribed to the carrier's mobile plan, the Watch's mobile network is turned off to save battery power and the network services may not be available.

## Data usage (SM-R935F, SM-R945F, SM-R955F, SM-R965F)

Keep track of your data usage amount and customise the limit settings. Set the Watch to automatically disable the mobile data connection when you have reached your specified mobile data limit.

On the Settings screen, tap **Connections** → **Data usage**.

- **Start billing cycle on:** Set the monthly start date of your plan's data usage.
- **Set data limit:** Turn on or off the feature to automatically disable the mobile data connection when you have reached your specified mobile data limit.
- **Data limit:** Set the mobile data limit.

## Modes

Turn modes that sync with your connected phone based on your current activity or location on or off.

On the Settings screen, tap **Modes**.

- 1 Select the mode you want.

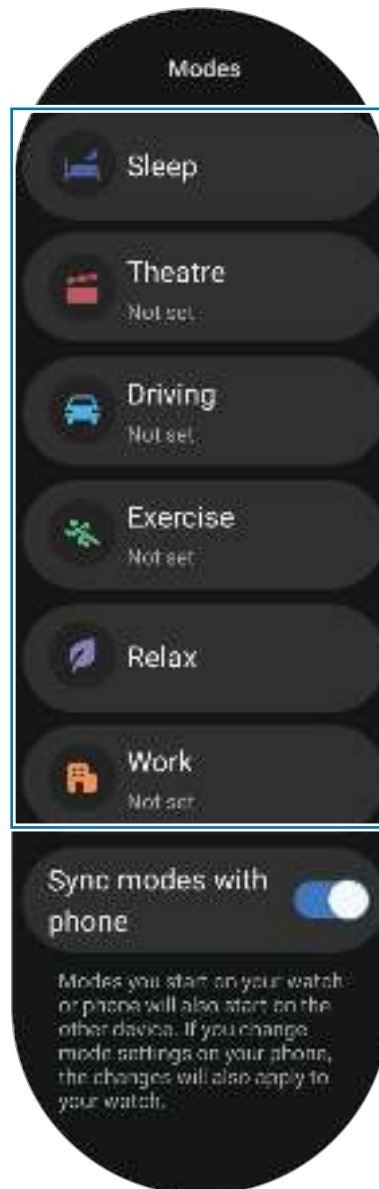

- 2 Tap **Turn on**.

For modes that run automatically, it will be turned on when the conditions added on the connected phone are detected.

To change the mode settings, tap **Set on phone** and configure the settings on the connected phone.

If mode sync is not working between your connected phone and Watch, tap the **Sync modes with phone** switch to turn it on. Any new modes added or mode settings changed on the connected phone are synchronised with the Watch, as is the running status of the modes.

-  Only some modes are available if the **Sync modes with phone** feature is turned off, or if the connected phone has a different software version.

## Notifications

Change the notification settings.

On the Settings screen, tap **Notifications**.

- **App notifications:** Select a phone or Watch app to receive notifications for on your Watch.
- **Show phone notifications on watch:** Set the Watch to display phone notifications depending on the phone's usage status.
- **Mute notifications on phone:** Set to mute app notifications on your phone when they will be displayed on the Watch.
- **Do not disturb:** Set the Watch to mute all notifications except for those you allow.
- **Advanced settings:** Configure advanced settings for notifications.

## Sounds and vibration

Change the sound and vibration settings.

On the Settings screen, tap **Sounds and vibration**.

- **Sound / Vibrate / Mute:** Set to use sound mode, vibrate mode, or silent mode.
- **Vibrate with sound:** Set the Watch to vibrate with sound.
- **Vibration:** Set the vibration duration and intensity.
- **Call vibration:** Select a vibration pattern for incoming calls.
- **Notification vibration:** Select a vibration pattern for notifications.
- **System vibration:** Enable vibrations for certain actions.
- **Volume:** Adjust the volume level.
- **Ringtone:** Change the ringtone.
- **Notification sound:** Change the notification sound.
- **System sounds:** Enable sounds for certain actions.

## Display

Change the screen settings.

On the Settings screen, tap **Display**.

- **Brightness:** Adjust the brightness of the screen.
- **Adaptive brightness:** Set the Watch to keep track of your brightness adjustments and apply them automatically in similar lighting conditions.
- **Always On Display:** Set the Watch screen and some apps' screens to always stay on while wearing your Watch. However, the battery will drain more quickly than normal while using this feature.
- **Screen wake-up:** Select how to turn the screen on. Refer to [Turning the screen on](#) for more information.
- **Show media controls:** Set to automatically open the **Media Controller** app on your Watch when music or video is played on the connected phone.
- **Screen timeout:** Set the length of time the Watch waits before turning off the screen's backlight.
- **Show last app:** Set the time to keep the last-used app on after the screen is turned off. If you turn the screen on again within the time you set after it has been turned off, the app screen you last used will appear instead of the Watch screen.
- **Font:** Set the font style for the screen.
- **Touch sensitivity:** Set the Watch to enable the use of the touch screen with gloves on.
- **Show charging info:** Set the Watch to display the charging information when the screen is off while charging.

## Health

Configure the various settings related to exercise and fitness.

On the Settings screen, tap **Health**.

- **Measurement:** Set how to measure your heart rate and stress, and turn the additional features that can be measured during sleep on or off.
- **Labs:** Use new features of the Watch.
- **Auto detect workouts:** Turn on the auto detect feature and configure the settings, such as selecting the exercise types to be detected.

- **Inactive time:** Turn the feature on to receive alerts after 50 minutes of inactivity, and set the time and days you want to be notified.
- **Make visible to other devices:** Allow other devices to find your Watch.
- **Share data with devices and services:** Set to share information with other connected health platform apps, exercise machines, and TVs.
- **Privacy:** Select apps or service providers to share information with to display the necessary information during exercise.

## Security and privacy

Check the Watch's security and privacy status and change the settings.

On the Settings screen, tap **Security and privacy**.

- **Lock type:** Change the screen lock method. Refer to [Lock screen](#) for more information.
- **Privacy:** Change the privacy settings, and set to get personalised service based on your interests and how you use your Watch.
- **Wrist detection:** Set to detect whether you are wearing the Watch.

## Location

Change settings for location information usage.

On the Settings screen, tap **Location**.

- **App permissions:** Check the list of apps that have permission to access the Watch's location and edit the permission settings.
- **Location services:** Check the location services your Watch is using.

## Safety and emergency

Manage your medical information and emergency contacts. You can also set to request an SOS automatically or manually when you are in an emergency situations. Refer to [Sending an SOS](#) for more information.

On the Settings screen, tap **Safety and emergency**.

- **Medical info:** Enter your medical information.
- **Emergency contacts:** Add your emergency contacts.
- **Emergency SOS:** Set to request an SOS by pressing the Watch's Home button five times in an emergency.
- **Hard fall detection:** Set to request an SOS automatically or manually when your Watch detects a hard fall.
- **Emergency sharing:** Send a message that includes your location information and a low battery alert warning to emergency contacts.
- **Wireless Emergency Alerts:** Change settings for emergency features, such as wireless emergency alerts.

## Accounts and backup

You can use various features of the Watch after registering your Samsung or Google account on your connected phone and add them on your Watch. You can also regularly back up your Watch's data and files automatically with Smart Switch on your connected phone.

On the Settings screen, tap **Accounts and backup**.

- **Accounts:** Register your Samsung or Google account on your connected phone and add it to your Watch. Refer to [Adding the accounts to your Watch](#) for more information.
- **Backup:** Check the data of your Watch that is backed up automatically with Smart Switch on your connected phone.

## Google

Change the settings for Google.

On the Settings screen, tap **Google**.

- **Accounts:** Check the Google Account registered on your connected phone and add it to your Watch.

## Advanced features

Turn on the advanced features.

On the Settings screen, tap **Advanced features**.

- **Disconnection alerts:** Set to receive alerts when your Watch loses its Bluetooth connection to your phone while wearing it.
- **Water lock:** Turn on water lock mode before entering the water. When water lock mode is on, the features, such as the raise wrist to wake feature and Always On Display feature, including screen touches are automatically turned off.
- **Customise buttons:** Select an app or feature to launch when you press the Home button twice or press and hold it. You can also select a feature to launch when you press the Back button.
- **Status indicators:** Change the display settings for the status indicator icons at the top of the Watch screen.
- **Gestures:** Turn on the gestures feature and configure the settings. Refer to [Gestures](#) for more information.

## Gestures

Turn on the gestures feature and configure the settings.

On the Settings screen, tap **Advanced features** and select the feature you want under **Gestures**.

- **Answer calls:** Set to answer calls by shaking the arm which is wearing the Watch twice while bending at the elbow.
- **Dismiss alerts and calls:** Set to dismiss alerts and decline calls by rotating the wrist you are wearing your Watch on twice.

- **Quick launch:** Set to launch the selected feature by bending the wrist you are wearing your Watch on up and down twice within five seconds after turning on the screen while closing your fist. Tap **Select an option** and set the feature to be turned on with this method.

## Battery and device care

The device care feature provides an overview of the status of your Watch's battery, storage, and memory.

### Battery

Check the remaining battery power and time to use the Watch. If the battery is low, turn on power saving mode to reduce battery consumption.

On the Settings screen, tap **Battery and device care** → **Battery**.

- **Power saving:** Turn on power saving mode to extend the battery's usage time.
- **Sleeping apps:** Select apps to sleep in the background. Sleeping apps only run in the background occasionally to extend the battery's usage time.
- **Watch only:** Only the watch appears on the screen and all other features will be turned off to reduce the battery consumption. Press the Home button to check the watch. To turn off watch only mode, press and hold the Home button. Alternatively, place the Watch on the wireless charger.

 The usage time left shows the time remaining before the battery power runs out. Usage time left may vary depending on your Watch settings and operating conditions.

### Storage

Check the status of the used and available storage.

On the Settings screen, tap **Battery and device care** → **Storage**.

-  The actual available capacity of the internal storage is less than the specified capacity because the operating system and default apps occupy part of the storage. The available capacity may change when you update the Watch.
- You can check the available capacity of the internal storage in the Specification section for your Watch on the Samsung website.



## Memory

On the Settings screen, tap **Battery and device care** → **Memory**.

To speed up your Watch by stopping apps running in the background, tick apps from the apps list, and tap **Clean now**.

## Apps

Configure the settings for the Watch's app.

On the Settings screen, tap **Apps**.

- **Choose default apps:** Choose default apps for similar features.
- **Health Platform:** Set your profile to be used for managing your health data and set to share information with other connected health apps.
- **App list:** Manage the Watch's apps. You can also check the apps' usage information and uninstall or disable unnecessary apps.
- **Permission manager:** Check the permission list for all apps, including the system apps, and change their permission settings.
- **Samsung app updates:** Check for updates for some preinstalled Samsung apps.

## General

Customise your Watch's general settings. You can also connect your Watch to a new phone or reset the Watch.

On the Settings screen, tap **General**.

- **Touch bezel:** Change the touch bezel settings. (Galaxy Watch6)
- **Text-to-speech:** Change the settings for text-to-speech features used when TalkBack is turned on, such as languages, speed, and more.
- **Input:** Change the settings for the keyboard and set the quick responses feature.
- **Date and time:** Set the date and time manually.
  -  Disconnect your Watch from the phone to use this feature, since it is synced with the connected phone.
- **Orientation:** Set the Watch to match the wrist you wear it on, whether left or right, and the orientation of the Home button or Back button after wearing your Watch.

- **Transfer watch to new phone:** Connect your Watch to a new phone that uses the same Google Account as your previous phone without resetting the Watch's data. Refer to [Connecting your Watch to a new phone](#) for more information.
- **Reset:** Delete all data on your Watch. However, if your Watch is connected to your phone before being reset, your Watch's data and files will be backed up.

## Accessibility

Configure various settings to improve accessibility to the Watch.

On the Settings screen, tap **Accessibility**.

- **Functions you're using:** Check the accessibility features you are using.  
 This feature appears only when using the accessibility feature.
- **TalkBack:** Turn on TalkBack, which provides voice feedback. To check help information to learn how to use this feature, tap **Settings** → **Tutorial and help**.
- **Visibility enhancements:** Customise the settings to improve accessibility for users who have impaired vision.
- **Hearing enhancements:** Customise the settings to improve accessibility for users who have impaired hearing.
- **Interaction and dexterity:** Customise the settings to improve accessibility for users who have reduced dexterity.
- **Advanced settings:** Manage other advanced functions.
- **Installed apps:** Check accessibility services installed on the Watch.

## Software update

Update your Watch's software through the firmware over-the-air (FOTA) service. You can also change the update settings.

On the Settings screen, tap **Software update**.

- **Download and install:** Check for and install updates manually.
- **Auto update:** Set the Watch to install updates automatically overnight, while it is being charged and has more than 30% of remaining battery power.

## About watch

Access the Watch's additional information.

On the Settings screen, tap **About watch**.

- **Status information:** Check out the information, such as the Wi-Fi MAC address, Bluetooth address, and serial number.
- **Legal information:** Access legal information related to the Watch. You can also send the Watch's diagnostic information to Samsung.
- **Software information:** Access the software version and security status.
- **Battery information:** Check out the battery information.

# Galaxy Wearable app

## Introduction

To connect your Watch to a phone, you must install the Galaxy Wearable app on your phone. You can check the Watch's remaining battery and configure the settings with the Galaxy Wearable app.

Open the **Galaxy Wearable** app on your phone.

To search for settings by entering keywords, tap . You can also search for settings by selecting a tag under **Suggestions**.

 Some features may not be available depending on the type of connected phone.

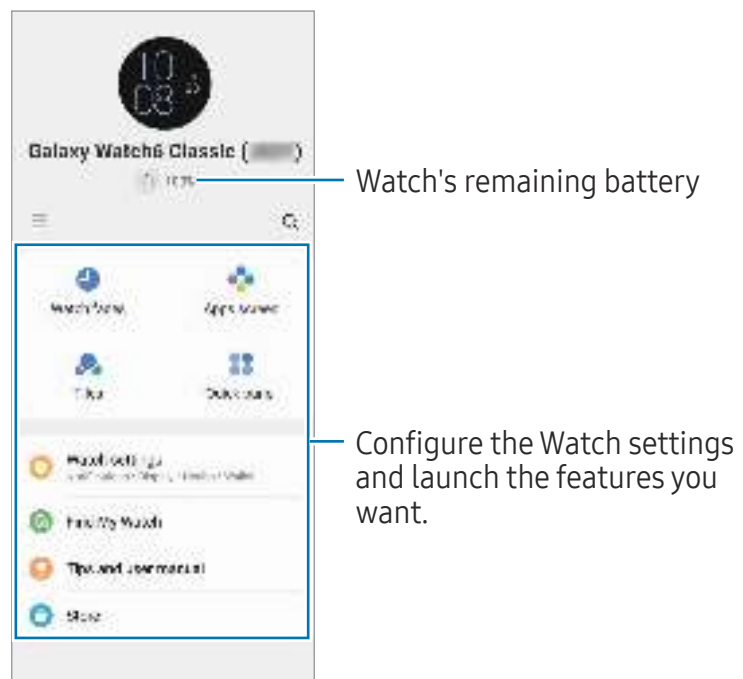

Tap  to use the following additional options:

- : Configure the settings for the Galaxy Wearable app.
- **Add new device:** Disconnect your device from the currently connected phone and connect a new device. Follow the on-screen instructions to complete the connection. Refer to [Connecting the Watch to a phone through Bluetooth](#) for more information.

- **Manage devices:** Manage connected devices when more than two devices are connected with your phone. To disconnect a device from your phone, select a device and tap **Remove**.



Some features may not be available depending on the region, carrier, or model.

## Watch faces

You can change the type of watch to be displayed on the Watch screen.

On the Galaxy Wearable screen of the phone, tap **Watch faces**.

Select a watch face you want and tap **Customise** to change screen colours or components, such as clock hands and dials, and even select items to display on the Watch screen.

### Making My style watch faces

Change your watch face into a pattern image that uses a colour combination abstracted from the picture you took. You can match your Watch's watch face with any fashion you want.



This feature is only available on Samsung or Android phones.

- 1 On the Galaxy Wearable screen of the phone, tap **Watch faces**.
- 2 Select **My style** under **Graphical**.
- 3 Tap **Customise** → **Background** → **Camera**.  
To select a picture saved on your phone, tap **Gallery**.
- 4 Tap  to take a picture and then tap **OK**.
- 5 Drag the part of the picture you want to use into the circle, or adjust the size of the picture to select the colour you want to use.
- 6 Select a pattern type and tap **Done**.
- 7 Tap **Save**.  
The watch face will be changed into the My style one.

## Making AR emoji watch faces

Change your watch face into your own AR emoji.

 This feature is only available on Samsung phones that support the AR emoji features.

- 1 On the Galaxy Wearable screen of the phone, tap **Watch faces**.
- 2 Select **AR Emoji** under **Graphical**.
- 3 Tap **Customise** → **Character**.
- 4 Tap  and follow the on-screen instructions to create your AR emoji.
- 5 Select the created AR emoji under **Other emojis** to transfer it to your Watch.
- 6 Tap **Save**.  
The watch face will be changed into the AR emoji one.



## Apps screen

Rearrange apps on the Apps screen.

On the Galaxy Wearable screen of the phone, tap **Apps screen**.

To rearrange apps, touch and hold an app to move, drag it to the desired position, and then tap **Save**.

## Tiles

Customise the tiles on the Watch. You can also rearrange tiles.

On the Galaxy Wearable screen of the phone, tap **Tiles**.

### Adding or removing tiles

Tap the tiles you want to add under **Add tiles** or tap  on the tiles you want to remove, and then tap **Save**.

### Rearranging tiles

Touch and hold a tile you want to move, drag it to the desired position, and then tap **Save**.

## Quick panel

Select the quick settings icons displayed on the quick panel of your Watch. You can also rearrange quick settings icons.

On the Galaxy Wearable screen of the phone, tap **Quick panel**.

### Adding or removing quick settings icons

Tap  on the icon to add under **Available buttons** or tap  on the icon to remove, and then tap **Save**.

### Rearranging quick settings icons

Touch and hold an icon to move, drag it to the desired position, and then tap **Save**.

# Watch settings

## Introduction

Check your Watch's status and configure your Watch settings.

On the Galaxy Wearable screen of the phone, tap **Watch settings**.

## Samsung account

Register the Samsung account on your connected phone or check the previously registered Samsung account.

On the Galaxy Wearable screen of the phone, tap **Watch settings** → **Samsung account**.

Refer to [Registering a Samsung account on your Watch](#) for more information.

## Modes

Set to sync the mode settings of your Watch and phone.

On the Galaxy Wearable screen of the phone, tap **Watch settings** → **Modes**.

- **Sync modes with phone:** Set to sync the mode settings of your Watch and phone. When turning on this feature, any new modes added or mode settings changed on your connected phone will be synchronised with the Watch, as is the running status of the modes.



Only some mode syncing features may be supported depending on the software version of the connected phone.

## Notifications

Change the notification settings.

On the Galaxy Wearable screen of the phone, tap **Watch settings** → **Notifications**.

- **App notifications:** Select a phone or Watch app to receive notifications for on your Watch.
- **Show phone notifications on watch:** Set the Watch to display phone notifications depending on the phone's usage status.
- **Mute notifications on phone:** Set to mute app notifications on your phone when they will be displayed on the Watch.



- **Sync Do not disturb with phone:** Set to sync the do not disturb settings of your Watch and phone.
- **Advanced notification settings:** Configure advanced settings for notifications.

## Sounds and vibration

Change the sound and vibration settings.

On the Galaxy Wearable screen of the phone, tap **Watch settings** → **Sounds and vibration**. Refer to [Sounds and vibration](#) in Apps and features for more information.

## Display

Change the screen settings.

On the Galaxy Wearable screen of the phone, tap **Watch settings** → **Display**. Refer to [Display](#) in Apps and features for more information.

## Health

Configure the various settings related to exercise and fitness.

On the Galaxy Wearable screen of the phone, tap **Watch settings** → **Health**. Refer to [Health](#) in Apps and features for more information.

## Samsung Wallet / Samsung Pay

Use various convenient features in Samsung Wallet or Samsung Pay.

On the Galaxy Wearable screen of the phone, tap **Watch settings** → **Samsung Wallet** or **Samsung Pay**.



This feature may not be available depending on the region or connected phone.

## Safety and emergency

Manage your medical information and emergency contacts. You can also set to request an SOS automatically or manually when you are in an emergency situations. Refer to [Safety and emergency](#) in Apps and features or [Sending an SOS](#) for more information.

On the Galaxy Wearable screen of the phone, tap **Watch settings** → **Safety and emergency**.

## Accounts and backup

You can use various features of the Watch after registering your Samsung or Google account on your connected phone and add them on your Watch. You can also regularly back up your Watch's data and files automatically with Smart Switch on your connected phone and save the backup to Samsung Cloud.

On the Galaxy Wearable screen of the phone, tap **Watch settings** → **Accounts and backup**.



- Save the Watch's data and files that are automatically backed up periodically to Samsung Cloud, so that you can restore them if the data and files are damaged or lost caused by an unintended factory data reset.
- For the Samsung Health app, only records from the previous 28 days are saved on your Watch. To check saved records older than 28 days, install the Samsung Health app on the connected phone and back up data automatically.
- **Accounts:** Register your Samsung or Google account on your connected phone and add it to your Watch. Refer to [Adding the accounts to your Watch](#) for more information.
- **Backup:** Check your Watch's data that is backed up automatically with Smart Switch on your connected phone, and tap the **Save backup to Samsung Cloud** switch to turn it on to store the backup on the Samsung Cloud.

## Advanced features

Turn on the advanced features.

On the Galaxy Wearable screen of the phone, tap **Watch settings** → **Advanced features**. Refer to [Advanced features](#) in Apps and features for more information about other features besides those listed.

- **Remote connection:** Set the Watch to remotely connect to your phone with the mobile network or Wi-Fi network when a Bluetooth connection between devices is unavailable.

## Battery and device care

The device care feature provides an overview of the status of your Watch's battery, storage, and memory. You can also test your Watch.

On the Galaxy Wearable screen of the phone, tap **Watch settings** → **Battery and device care**. Refer to [Battery and device care](#) in Apps and features for more information about other features besides those listed.

- **Diagnostics:** Test your Watch using Samsung Members.

## Apps

Configure the settings for the Watch's app.

On the Galaxy Wearable screen of the phone, tap **Watch settings** → **Apps**.

- **App settings:** Change the detailed settings for some of the Watch's apps.
- **Your apps:** Manage the Watch's apps and check each app's usage information, or uninstall or disable unnecessary apps.

## Manage content

Sync saved audio or image files from your phone to your Watch, or transfer them to your Watch.

On the Galaxy Wearable screen of the phone, tap **Watch settings** → **Manage content**.

- **Music**
    - **Tracks on watch:** Check and manage the audio files on your Watch by category. Refer to [Managing audio files saved on your Watch](#) for more information.
    - **Auto sync:** Set the phone to automatically sync audio files added to the playlists selected as **Playlists to sync** every six hours with the Watch.
    - **Playlists to sync:** Select a playlist to sync with the Watch automatically.
-  This feature may appear only when the Samsung Music app is installed on your phone and when you turn on the **Auto sync** feature.

- **Gallery**

- **Add images:** Transfer pictures from your phone to your Watch. Refer to [Transferring pictures to your Watch](#) for more information.
- **Auto sync albums:** Set the phone to automatically sync images added to the albums selected as **Albums to sync** with the Watch.
- **Albums to sync:** Select an album to sync with the Watch automatically.
- **Auto sync image limit:** Select the number of images to send to your Watch from a phone at one time.

 **Albums to sync** and **Auto sync image limit** may appear when you turn on the **Auto sync albums** feature.

- **Auto sync latest story:** Set the phone to automatically sync your most recent story with the Watch.

 File syncing between your Watch and phone can occur only when your Watch has more than 15% of battery power remaining and when power saving mode is turned off on your Watch.

## Mobile plans (SM-R935F, SM-R945F, SM-R955F, SM-R965F)

Use various other services through the mobile network after activating it on the Watch. On the Galaxy Wearable screen of the phone, tap **Watch settings** → **Mobile plans**.

## General

Customise your Watch's general settings. You can also connect your Watch to a new phone or reset the Watch.

On the Galaxy Wearable screen of the phone, tap **Watch settings** → **General**. Refer to [General](#) in Apps and features for more information.

## Accessibility

Configure various settings to improve accessibility to the Watch.

On the Galaxy Wearable screen of the phone, tap **Watch settings** → **Accessibility**. Refer to [Accessibility](#) in Apps and features for more information.

## Watch software update

Update your Watch's software through the firmware over-the-air (FOTA) service. You can also change the update settings.

On the Galaxy Wearable screen of the phone, tap **Watch settings** → **Watch software update**. Refer to [Software update](#) for more information.

## About watch

Access the Watch's additional information.

On the Galaxy Wearable screen of the phone, tap **Watch settings** → **About watch**. Refer to [About watch](#) in Apps and features for more information.

## Find My Watch

Find your lost or misplaced Watch and remotely control it.

On the Galaxy Wearable screen of the phone, tap **Find My Watch**.

- **Start:** Check where your Watch is now. Refer to [Find My Watch](#) in Apps and features for more information.
- **Set security:**
  - **Lock watch:** Remotely lock the Watch to prevent unauthorised access. This feature can be used when your phone is connected to your Watch through Bluetooth or a remote connection. When your Watch is locked, unlock it manually by entering a preset PIN, or connect the Watch to your phone through Bluetooth again to unlock it automatically.
  - **Reset watch:** All data stored in your Watch is deleted. After the Watch is reset, you cannot restore the information or use the **Find My Watch** feature. However, data that was backed up and stored while your Watch and phone were connected before the reset is available on the Samsung Cloud.

## Store

Download the apps and watch faces to be used on your Watch.



On the Galaxy Wearable screen of the phone, tap **Store**.

# Usage notices

## Precautions for using the device

Please read this manual when using the device to ensure safe and proper use.



- Descriptions are based on the device's default settings.
- Some content may differ from your device depending on the region, service provider, model specifications, or device's software.
- The device may require a connection to a Wi-Fi or mobile network when using some apps or features.
- Content (high quality content) that requires high CPU and memory usage will affect the overall performance of the device. Apps related to the content may not work properly depending on the device's specifications and the environment that it is used in.
- Samsung is not liable for performance issues caused by apps supplied by providers other than Samsung.
- Samsung is not liable for performance issues or incompatibilities caused by edited registry settings or modified operating system software. Attempting to customise the operating system may cause the device or apps to work improperly.
- Software, sound sources, wallpapers, images, and other media provided with this device are licensed for limited use. Extracting and using these materials for commercial or other purposes is an infringement of copyright laws. Users are entirely responsible for illegal use of media.
- You may incur additional charges for data services, such as messaging, uploading and downloading, autosyncing, or using location services depending on your data plan. For large data transfers, it is recommended to use the Wi-Fi feature.
- Default apps that come with the device are subject to updates and may no longer be supported without prior notice.
- This device's operating system is different from some previous series of the Galaxy Watch, and you cannot use previously purchased content because of compatibility issues.
- The model specifications and supported services may differ depending on the region.

- Modifying the device's operating system or installing software from unofficial sources may result in device malfunctions and data damage or loss. These actions are violations of your Samsung licence agreement and will void your warranty.
- Some features may not work as described in this manual depending on the maker and model of the phone you connect to your Watch.
- You can see the touch screen clearly even in strong outdoor sunlight by automatically adjusting the contrast range based on the surrounding environment. Because of the nature of the product, displaying fixed graphics for extended periods may result in afterimages (screen burn-in) or ghosting.
  - It is recommended not to use fixed graphics on part or all of the touch screen for extended periods and turn off the touch screen when not using the device.
  - You can set the touch screen to turn off automatically when you are not using it. On the Watch's Apps screen, tap  (**Settings**) → **Display** → **Screen timeout**, and then select the length of time you want the device to wait before turning off the touch screen.
  - To set the touch screen to automatically adjust its brightness based on the surrounding environment, on the Watch's Apps screen, tap  (**Settings**) → **Display**, and then tap the **Adaptive brightness** switch to turn it on.
- Depending on the region or model, some devices are required to receive approval from the Federal Communications Commission (FCC).

If your device is approved by the FCC, you can check out the FCC ID of the Watch. To access the FCC ID, on the Watch's Apps screen, tap  (**Settings**) → **About watch** → **Status information**. If your device does not have an FCC ID, it means that the device has not been authorised for sale in the U.S. or its territories and may only be brought to the U.S. for the owner's personal use.

- Depending on the region, you can check out the regulatory information on the device. To access the information, on the Watch's Apps screen, tap  (**Settings**) → **About watch** → **Regulatory information**.
- Your device contains magnets. Keep it away from credit cards, implanted medical devices, and other devices that may be affected by magnets. In the case of medical devices, keep your device more than 15 cm apart. Stop using your device if you suspect any interference with your medical device and consult your physician or your medical device manufacturer.

## Instructional icons

-  **Warning:** situations that could cause injury to yourself or others
-  **Caution:** situations that could cause damage to your device or other equipment
-  **Notice:** notes, usage tips, or additional information

## Notes on package contents and accessories

Refer to the quick start guide for package contents.

- The items supplied with the Watch and any available accessories may vary depending on the region or carrier.
- The supplied items are designed only for this device and may not be compatible with other devices.
- Appearances and specifications are subject to change without prior notice.
- You can purchase additional accessories from your local Samsung retailer. Make sure they are compatible with the Watch before purchase.
- Except for the Watch, some supplied items and accessories may not have the same water- and dust-resistance certification.
- Use Samsung-approved accessories. Using unapproved accessories may cause the performance problems and malfunctions that are not covered by the warranty.
- Availability of all accessories is subject to change depending entirely on manufacturing companies. For more information about available accessories, refer to the Samsung website.



## Maintaining the device's water and dust resistance

- This device is water and dust resistant, and meets the following international standards.
  - 5ATM water resistance classification certification: Was tested by submerging the device in 50 m of fresh water for 10 minutes, leaving it still, without any movement, to meet the requirements of ISO 22810:2010.
  - IPX8 water resistance classification certification: Was tested by submerging the device in 1.5 m of fresh water for 30 minutes, leaving it still, without any movement, to meet the requirements of IEC 60529.
  - IP6X dust resistance classification certification: Was tested to meet the requirements of IEC 60529.
- You can use this device when you are exercising, washing your hands or on a rainy day.
- You can use this device when you are swimming in a pool or the sea where the water level is not deep.
- The water resistance of your Galaxy device is not permanent and may diminish over time. It is recommended to have your Galaxy device's water resistance tested once a year at a Samsung Service Centre or an authorised service centre.
- You must follow these guidelines to maintain the water and dust resistance of your device.
  - After swimming, and before the pool water or seawater has dried, rinse the device with fresh water and dry it thoroughly with a soft, clean cloth to maintain its water resistance. The water resistance may be affected by the disinfectants in swimming pool water or the salt in seawater.
  - If the device gets wet with liquid other than fresh water, such as coffee, drinks, soapy water, oil, perfume, sunscreen, hand sanitiser, or chemical products like cosmetics, rinse the device with fresh water and dry it thoroughly with a soft, clean cloth to maintain its water resistance.

- Do not stay submerged underwater, go snorkelling, diving or scuba diving, or play water sports like water-skiing or surfing, and do not swim in fast-moving water, such as a river, while wearing your device. Also, do not expose it to high-pressure cleaning machines or similar things. This would result in a dramatic rise in water pressure which could cause the water resistance guaranteed by our company to change.
- If the device is hit or damaged, its water and dust resistance may be compromised.
- Do not disassemble your device without proper guidance.
- If you dry your device with a machine that gives off hot air, like a hair dryer, or if you use your device in a hot environment like a sauna, the water resistance could be damaged from a dramatic change in the air or water temperature.

## Precautions for overheating

If you feel discomfort because of overheating while using the device, stop using it immediately and remove it from your wrist.

- To avoid problems, such as device malfunction, skin discomfort or damage, and battery draining, a warning will appear on the device if it reaches a specific temperature. When the initial warning appears, device features will be turned off until the device cools down to a specific temperature. However, the emergency call feature will be available on the LTE model.
- If the device temperature continues to increase, a second warning will appear. At this time, the device will power off. Do not use the device until the device's temperature is within the recommended operating temperature range. However, when using the LTE model, the emergency call feature that has been previously connected will remain enabled until you are finished, even though the second warning will appear.

### **Recommended operating temperature range**

The device's recommended operating temperature is between 0°C to 35°C. Using the device outside of the recommended temperature range may damage the device or reduce the battery's lifespan.

## Cleaning and managing the Watch

Follow these points to ensure your Watch works correctly and maintains its appearance. Failure to do so may damage the Watch and cause the skin irritation.

- Turn off the Watch and remove the band before cleaning it.
- Prevent the device from being exposed to dust, sweat, ink, oil, and chemical products such as cosmetics, antibacterial spray, hand cleaner, detergent, and insecticides. The Watch's exterior and interior parts may be damaged or it could result in poor performance. If your Watch is exposed to any of the previously mentioned substances, use a lint-free, soft cloth to clean it.
- Do not use soap, cleaning agents, abrasive materials and compressed air when cleaning your Watch and do not clean it with the ultrasonic waves or the external heat sources. Doing so may damage the Watch. Skin irritation may be caused by soap, detergents, hand sanitisers, or cleaning agents left on the Watch.

- When you remove sunblock, lotion, or oil, use a soap-free detergent, then rinse and dry your Watch thoroughly.
  - The hybrid band is not water-resistant. Do not swim or take a shower while using the hybrid band.
  - The hybrid band may make squeaking sound where it connects with the Watch because of the characteristics of the leather material. This is normal and you can address this issue by applying leather care products to the band at the connection point.
  - Avoid exposing the Watch's hybrid band to chemicals, direct sunlight, hot or humid environments, or water. The leather material's colour and form may change if you do so. If it gets wet, wipe it with a soft, lint-free cloth immediately and dry it in a well-ventilated and shaded place.
  - When your hybrid band get stained, wipe it with a soft, lint-free cloth. If necessary, slightly dampen a cloth with fresh water.
-  The supplied band may vary depending on the region or model. Be sure to properly clean and maintain your band accordingly.

## Use caution if you are allergic to any materials on the Watch

- Samsung has tested the noxious materials found on the Watch through the internal and external certificate authorities, including the test for all materials which contact with skin, skin toxicity test, and the Watch-wearing test.
- The Watch includes nickel. Take the necessary precautions if your skin is hypersensitive or you have an allergy to any materials found on the Watch.
  - **Nickel:** The Watch contains a small amount of nickel, which is below its reference point limited by the Europe REACH regulation. You will not be exposed to the nickel inside the Watch and the Watch has passed the international certificated test. However, if you are sensitive to nickel, be careful to use the Watch.
- Only the materials observed the standards of the U.S Consumer Product Safety Commission (CPSC), the regulations of the European countries, and other international standards are used to make a Watch.
- For more information about how Samsung manages chemicals, refer to the Samsung website.

# Appendix

## Troubleshooting

Before contacting a Samsung Service Centre or an authorised service centre, please attempt the following solutions. Some situations may not apply to your Watch.

You can also use Samsung Members to solve any problems you might encounter while using your device.

### The Watch displays network or service error messages

- When you are in areas with weak signals or poor reception, you may lose reception. Move to another area and try again. While moving, error messages may appear repeatedly.
- You cannot access some options without a subscription. For more information, contact your carrier.

### Your Watch does not turn on

When the battery is completely discharged, your Watch will not turn on. Fully charge the battery before turning on the Watch.

### The touch screen responds slowly or improperly

- If you attach a screen protector or optional accessories to the touch screen, the touch screen may not function properly.
- If you are wearing gloves, if your hands are not clean while touching the touch screen, or if you tap the screen with sharp objects or your fingertips, the touch screen may malfunction.
- The touch screen may malfunction in humid conditions or when exposed to water.
- Restart your Watch to clear any temporary software problems.
- Ensure that your Watch software is updated to the latest version.
- If the touch screen is scratched or damaged, visit a Samsung Service Centre or an authorised service centre.

## Your Watch freezes or encounters a problem

Try the following solutions. If the problem is still not resolved, contact a Samsung Service Centre or an authorised service centre.

### Restarting the Watch

If your Watch freezes or hangs, you may need to close apps or turn off the Watch and turn it on again.

### Forcing restart

If your Watch is frozen and unresponsive, press and hold the Home button and the Back button simultaneously for more than 7 seconds to restart it.

### Resetting the Watch

If the methods above do not solve your problem, perform a factory data reset.

On the Apps screen, tap  (Settings) → **General** → **Reset** → **Reset**. Alternatively, open the **Galaxy Wearable** app on your phone and tap **Watch settings** → **General** → **Reset** → **Reset**. If your Watch and phone are not connected at the time of the Watch reset, the data stored on your Watch will be deleted.

## Another Bluetooth device cannot locate your Watch

- Ensure that the Watch's Bluetooth feature is turned on.
- Reset your Watch and try again.
- Ensure that your Watch and the other Bluetooth device are within the Bluetooth connection range (10 m). The distance may vary depending on the environment the devices are used in.

If the tips above do not solve the problem, contact a Samsung Service Centre or an authorised service centre.

## A Bluetooth connection is not established or your Watch and the phone are disconnected

- Ensure that the Bluetooth feature on both devices is turned on.
- Ensure there are no obstacles, such as walls or electrical equipment, between the devices.
- Ensure that the latest version of the Galaxy Wearable app is installed on the phone. If the Galaxy Wearable app is not the latest version, update the Galaxy Wearable app to the latest version.
- Ensure that your Watch and the other Bluetooth device are within the Bluetooth connection range (10 m). The distance may vary depending on the environment the devices are used in.
- Restart both devices and open the **Galaxy Wearable** app on the phone again.

## Calls are not connected

- Ensure that your Watch is connected to a phone through Bluetooth.
- Ensure that your phone and Watch have accessed the right cellular network.
- Ensure that you have not set call barring for the phone number you are dialling on the phone.
- Ensure that you have not set call barring for the incoming phone number on the phone.
- Check if some modes are turned on. If some modes have been turned on, incoming calls may be muted and the screen may not turn on when receiving incoming calls. Turn on the screen and check the incoming call.

## Others cannot hear you speaking on a call

- Ensure that you are not covering the built-in microphone.
- Ensure that the microphone is close to your mouth.
- If using a Bluetooth headset, ensure that it is properly connected.

## Sound echoes during a call

Adjust the volume or move to another area.

## A cellular network or the internet is often disconnected or audio quality is poor

- Ensure that you are not blocking the Watch's internal antenna.
- When you are in areas with weak signals or poor reception, you may lose reception. You may have connectivity problems because of issues with the carrier's base station. Move to another area and try again.
- When using the device while moving, wireless network services may be unavailable because of issues with the carrier's network.

## The battery does not charge properly (For Samsung-approved chargers)

- Ensure that you connect the Watch to the wireless charger properly.
- Visit a Samsung Service Centre or an authorised service centre and have the battery replaced.

## The battery depletes faster than when first purchased

- When you expose the Watch or the battery to very cold or very hot temperatures, the useful charge may be reduced.
- Battery consumption increases when you use some apps.
- The battery is consumable and the useful charge will get shorter over time.

## Your Watch is hot to the touch

When you use apps that require more power or use apps on your Watch for an extended period of time, your Watch may feel hot to the touch. This is normal and should not affect your Watch's lifespan or performance.

If the Watch overheats or feels hot for a prolonged period, do not use it for a while. If the Watch continues to overheat, contact a Samsung Service Centre or an authorised service centre.



## Your Watch cannot find your current location

The Watch uses your phone's location information. GPS signals may be obstructed in some locations, such as indoors. Set to use Wi-Fi or a mobile network to find your current location.

## A small gap appears around the outside of the Watch case

- This gap is a necessary manufacturing feature and some minor rocking or vibration of parts may occur.
- Over time, friction between parts may cause this gap to expand slightly.

## There is not enough space in the Watch's storage

Delete unnecessary data, unused apps, or files to free up storage space.

## Removing the battery

- **To remove the battery, contact an authorised service centre. To obtain battery removal instructions, please visit [www.samsung.com/global/ecodesign\\_energy](http://www.samsung.com/global/ecodesign_energy).**
- For your safety, you **must not attempt to remove** the battery. If the battery is not properly removed, it may lead to damage to the battery and device, cause personal injury, and result in the device being unsafe.
- Samsung does not accept liability for any damage or loss (whether in contract or tort, including negligence) which may arise from failure to precisely follow these warnings and instructions, other than death or personal injury caused by Samsung's negligence.

## Copyright

Copyright © 2023 Samsung Electronics Co., Ltd.

This manual is protected under international copyright laws.

No part of this manual may be reproduced, distributed, translated, or transmitted in any form or by any means, electronic or mechanical, including photocopying, recording, or storing in any information storage and retrieval system.

## Trademarks

- SAMSUNG and the SAMSUNG logo are registered trademarks of Samsung Electronics Co., Ltd.
- Bluetooth® is a registered trademark of Bluetooth SIG, Inc. worldwide.
- Wi-Fi®, Wi-Fi Direct™, Wi-Fi CERTIFIED™, and the Wi-Fi logo are registered trademarks of the Wi-Fi Alliance.
- All other trademarks and copyrights are the property of their respective owners.