

Dishwasher

OWNER'S MANUAL

PHILCO



Famous for Quality the World Over

PDT 67 DF

**Dear customer,
Thank you for buying a PHILCO brand product. So that your appliance serves you well, please read all the instructions in this user's manual.**

CONTENTS

PART 1: SAFETY PRECAUTIONS	2
PART 2: PRODUCT OVERVIEW	5
PART 3: USING YOUR DISHWASHER	6
Loading The Salt Into The Softener.....	6
PART 4: MAINTENANCE AND CLEANING	8
External Care.....	8
Internal Care.....	8
Caring For The Dishwasher	10
PART 5: INSTALLATION INSTRUCTION	12
About Power Connection.....	12
Water Supply And Drain	13
Connection Of Drain Hoses	14
Positioning The Appliance.....	15
Built-In Installation.....	15
PART 6: TROUBLESHOOTING TIPS	19
Availability Of Spare Parts.....	21
PART 7: LOADING THE BASKETS ACCORDING TO EN60436	22
PART 8: QUICK USER GUIDE	24
PART 9: USING YOUR DISHWASHER	25
Control Panel	25
Water Softener	27
Preparing And Loading Dishes.....	28
Function Of The Rinse Aid And Detergent.....	31
Filling The Rinse Aid Reservoir.....	32
Filling The Detergent Dispenser	33
PART 10: PROGRAMMING THE DISHWASHER	34
Wash Cycle Table	34
Wash Cycle Table	35
Saving Energy	36
Starting A Programme.....	36
Changing The Program Mid-cycle.....	36
Forget To Add A Dish?	37
PART 11: ERROR CODES	38
PART 12: TECHNICAL INFORMATION	39
PART 13: PRODUCT INFORMATION SHEET	40
TECHNICAL INFORMATION	41
TESTING INFORMATION	41
CUSTOMER CARE AND SERVICE	41
INSTRUCTIONS AND INFORMATION REGARDING THE DISPOSAL OF USED PACKAGING MATERIALS.....	42
DISPOSAL OF USED ELECTRICAL AND ELECTRONIC APPLIANCES	42

PART 1: SAFETY PRECAUTIONS

 **WARNING!** Please adhere to the precautions below when using the dishwasher:

This appliance can be used by children aged from 8 years and above and by persons with reduced physical, sensory or mental capabilities or lack of experience and knowledge if they have been given supervision or instructions concerning use of the appliance in a safe way and if they understand the hazards involved.

Children must not play with the appliance.

Cleaning and user maintenance cannot be performed by children without supervision.

If the supply cable gets damaged, have it replaced by a specialized service center in order to avoid dangerous situations. It is prohibited to use an appliance with the supply cable damaged.

Do not leave the door in the open position to prevent the risk of tripping.

When storing dishes into the dishwasher:

-  **WARNING:** Knives and other utensils with sharp points and edges must be placed in the basket with points facing downwards or stored horizontally.
- Sharp items should be placed so that they cannot damage the door gasket.

- Knives and other similar sharp items should always be placed with their handles pointing upwards so that the sharp edge would not hurt anybody.
- Do not use the dishwasher to wash plastic items that have not been labeled as dishwasher safe by the manufacturer. The presence of plastic dishes in the dishwasher causes worsening of drying process results. Please adhere to the manufacturer's recommendations regarding plastic items that have not been labeled as dishwasher safe.

THIS APPLIANCE IS INTENDED TO BE USED ONLY IN HOUSEHOLDS AND NOT IN SIMILAR PREMISES, SUCH AS:

- kitchenettes in shops, offices and other workplaces;
 - agricultural facilities;
 - hotels, motels, and other accommodation facilities where appliances are used by guests;
 - bed and breakfast facilities.
- Do not sit or stand on the door and dish baskets of the dishwasher and to not use force during operation.
 - Do not place any heavy items on the appliance and do to stand on the door when it is open. The appliance might tip over towards the front.

Use only detergents and polishing agents intended to be used with automatic dishwashers. Never use soap, detergents or washing agents for manual dish washing.

Make sure to prevent children from accessing detergents and polishing agents and also open door of the dishwasher that might contain residues of the agents as they are strongly alkaline and might be very dangerous.

The appliance, the power cord or the electric outlet must not lie in, touch or be submerged in water or any other liquid to avoid electrical hazards.

If the power cord gets damaged, it must be replaced by the manufacturer, its service technician or another person with similar qualification so that safety is not jeopardized.

The appliance must not stand on the power cord.

The appliance should be connected to the water supply using a new hose, not using a hose that has already been used.

Dispose of packaging in a proper manner.

The power cord must not be excessively or dangerously bent or compressed during installation.

The controls are not to be played with.

Make sure that the openings in the bottom part of the appliance are not blocked by the carpet.

The dishwasher should be used only for the purpose it was intended for - for washing dishes.

This dishwasher is for interior use only.

PLEASE READ THOSE SAFETY PRECAUTIONS CAREFULLY AND STORE THEM FOR FUTURE REFERENCE

PART 2: PRODUCT OVERVIEW

IMPORTANT:

To get the best performance from your dishwasher, read all operating instructions before using it for the first time.

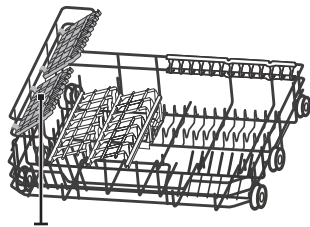
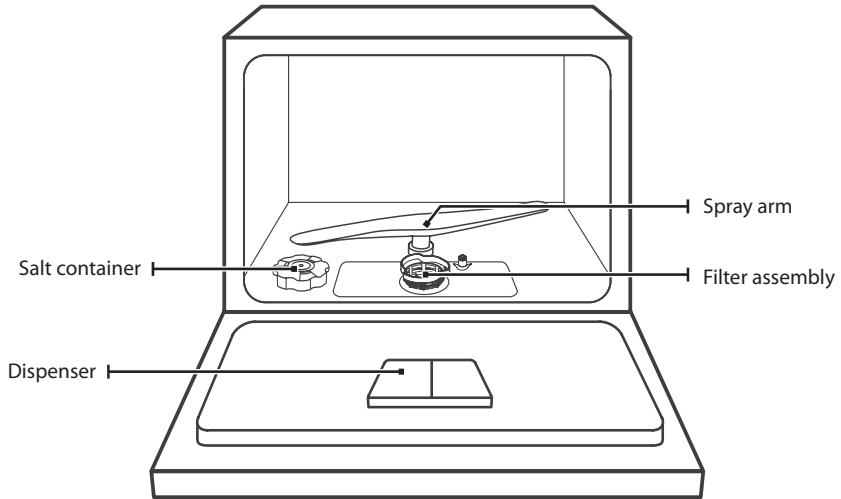

Cup rack

Basket

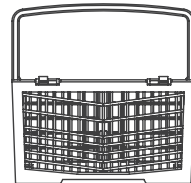

Cutlery rack

NOTE:

Pictures are only for reference, different models may be different.

PART 3: USING YOUR DISHWASHER

Before using your dishwasher:

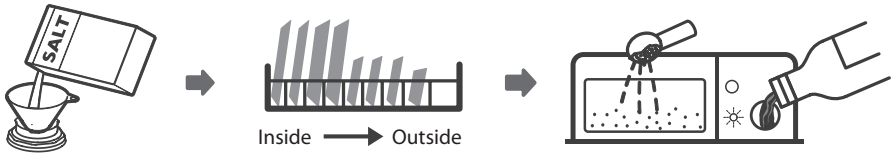

1. Set the water softener
2. Loading the salt into the softener
3. Loading the basket
4. Fill the detergent dispenser

NOTE:

Please check the section "Water Softener". If you need to set the water softener.

Loading The Salt Into The Softener

NOTE:

If your model does not have any water softener, you may skip this section.

Always use salt intended for dishwasher use.

The salt container is located beneath the lower basket and should be filled as explained in the following:



WARNING

- **Only use salt specifically designed for dishwashers use!**
Every other type of salt not specifically designed for dishwasher use, especially table salt, will damage the water softener. In case of damages caused by the use of unsuitable salt the manufacturer does not give any warranty nor is liable for any damages caused.
- **Only fill with salt before running a cycle.**
This will prevent any grains of salt or salty water, which may have been spilled, remaining on the bottom of the machine for any period of time, which may cause corrosion.

Please follow the steps below for adding dishwasher salt:

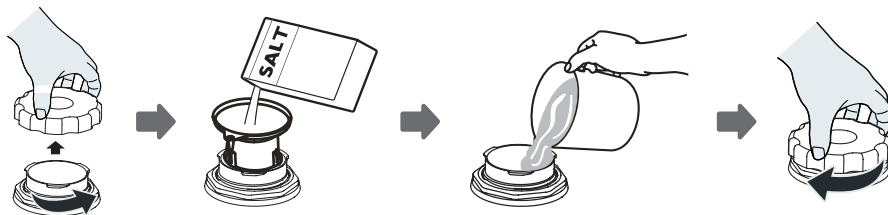

1. Remove the lower basket and unscrew the reservoir cap.
2. Place the end of the funnel (if supplied) into the hole and pour in about 1 kg of dishwasher salt.
3. Fill the salt container to its maximum limit with water, It is normal for a small amount of water to come out of the salt container.
4. After filling the container, screw back the cap tightly.
5. The salt warning light will turn off after the salt container has been filled with salt.
6. Immediately after filling the salt into the salt container, a washing program should be started (We suggest to use a short program). Otherwise the filter system, pump or other important parts of the machine may be damaged by salty water. This is out of warranty.

NOTE:

- The salt container must only be refilled when the salt warning light (S) in the control panel comes on. Depending on how well the salt dissolves, the salt warning light may still be on even though the salt container is filled. If there is no salt warning light in the control panel (for some models), you can estimate when to fill the salt into the softener by the cycles that the dishwasher has run.
- If salt has spilled, run a soak or quick program to remove it.

PART 4: MAINTENANCE AND CLEANING

External Care

The door and the door seal

Clean the door seals regularly with a soft damp cloth to remove food deposits.

When the dishwasher is being loaded, food and drink residues may drip onto the sides of the dishwasher door. These surfaces are outside the wash cabinet and are not accessed by water from the spray arms. Any deposits should be wiped off before the door is closed.

The control panel

If cleaning is required, the control panel should be wiped with a soft damp cloth only.



WARNING

- To avoid penetration of water into the door lock and electrical components, do not use a spray cleaner of any kind.
- Never use abrasive cleaners or scouring pads on the outer surfaces because they may scratch the finish. Some paper towels may also scratch or leave marks on the surface.

Internal Care

Filtering system

The filtering system in the base of the wash cabinet retains coarse debris from the washing cycle, including foreign objects such as tooth picks or shards. The collected coarse debris may cause the filters to clog. Check the condition of the filters regularly, carefully remove foreign objects and clean the parts of the filtering system if necessary with water. Follow the steps below to clean the filter.

NOTE:

Pictures are only for reference, different models of the filtering system and spray arms may be different.

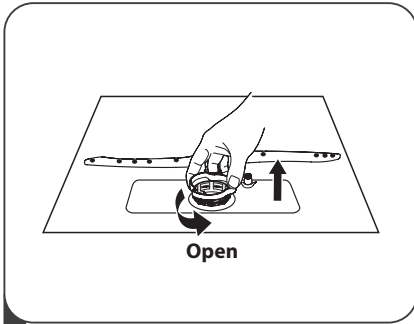

- 1** Hold the coarse filter and rotate it anticlockwise to unlock the filter. Lift the filter upwards and out of the dishwasher.

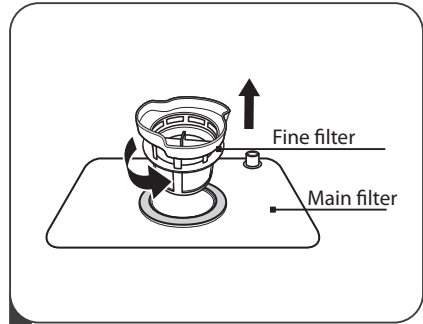

- 2** Lift fine filter up from main filter.

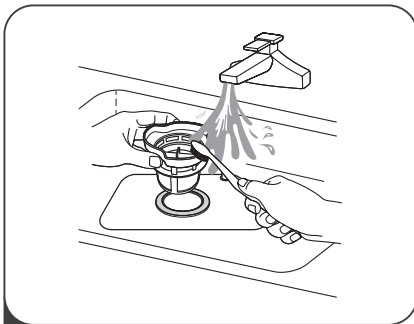

- 3** Larger food remnants can be cleaned by rinsing the filter under running water. For a more thorough clean, use a soft cleaning brush.

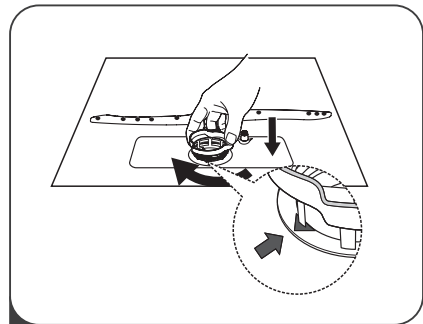

- 4** Reassemble the filters in the reverse order of the disassembly, replace the filter insert, and rotate clockwise to the close arrow.



WARNING

- Do not over tighten the filters. Put the filters back in sequence securely, otherwise coarse debris could get into the system and cause a blockage.
- NEVER use the dishwasher without filters in place. Improper replacement of the filter may reduce the performance level of the appliance and damage dishes and utensils.

Spray arm

It is necessary to clean the spray arm regularly for hard water chemicals will clog the spray arm jets and bearings.

To clean the spray arm, follow the instructions below:

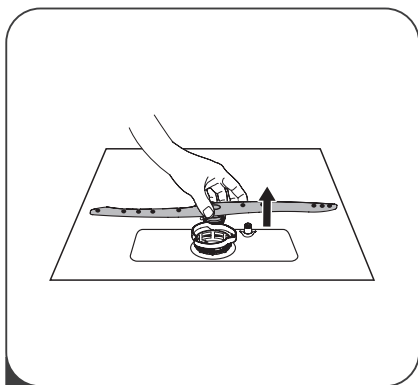

1 To remove the spray arm, pull out the spray arm upward.

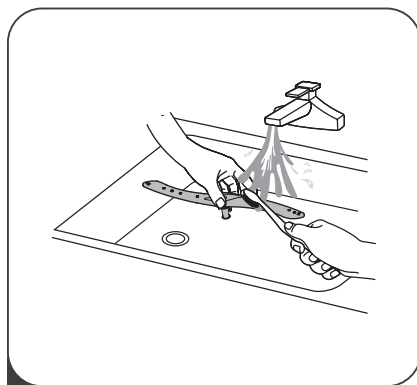

2 Wash the spray arm in soapy and warm water and use a soft brush to clean the jets. Replace them after rinsing them thoroughly.

Caring For The Dishwasher

Frost precaution

Please take frost protection measures on the dishwasher in winter. Every after washing cycles, please operate as follows:

1. Cut off the electrical power to the dishwasher at the supply source.
2. Turn off the water supply and disconnect the water inlet pipe from the water valve.
3. Drain the water from the inlet pipe and water valve. (Use a pan to gather the water)
4. Reconnect the water inlet pipe to the water valve.
5. Remove the filter at the bottom of the tub and use a sponge to soak up water in the sump.

After every wash

After every wash, turn off the water supply to the appliance and leave the door slightly open for a while so that moisture and odors are not trapped inside.

Remove the plug

Before cleaning or performing maintenance, always remove the plug from the socket.

No solvents or abrasive cleaning

To clean the exterior and rubber parts of the dishwasher, do not use solvents or abrasive cleaning products. Only use a cloth with warm soapy water.

To remove spots or stains from the surface of the interior, use a cloth dampened with water and a little vinegar, or a cleaning product made specifically for dishwashers.

When not in use for a long time

It is recommended that you run a wash cycle with the dishwasher empty and then remove the plug from the socket, turn off the water supply and leave the door of the appliance slightly open. This will help the door seals to last longer and prevent odors from forming within the appliance.

Moving the appliance

If the appliance must be moved, try to keep it in the vertical position. If absolutely necessary, it can be positioned on its back.

Seals

One of the factors that cause odours to form in the dishwasher is food that remains trapped in the seals. Periodic cleaning with a damp sponge will prevent this from occurring.

PART 5: INSTALLATION INSTRUCTION



Electrical Shock Hazard

Disconnect electrical power before installing dishwasher.
Failure to do so could result in death or electrical shock.



The installation of the pipes and electrical equipments should be done by professionals.

About Power Connection



For personal safety:

- Do not use an extension cord or an adapter plug with this appliance.
- Do not, under any circumstances, cut or remove the earthing connection from the power cord.

Electrical requirements

Please look at the rating label to know the rating voltage and connect the dishwasher to the appropriate power supply. Use the required fuse 10A/13A/16A, time delay fuse or circuit breaker recommended and provide separate circuit serving only this appliance.

Electrical connection

Ensure the voltage and frequency of the power being corresponds to those on the rating plate. Only insert the plug into an electrical socket which is earthed properly. If the electrical socket to which the appliance must be connected is not appropriate for the plug, replace the socket, rather than using a adaptors or the like as they could cause overheating and burns.



Ensure that proper earthing exists before use.

Water Supply And Drain

Cold water connection

Connect the cold water supply hose to a threaded 3/4 (inch) connector and make sure that it is fastened tightly in place.

If the water pipes are new or have not been used for an extended period of time, let the water run to make sure that the water is clear. This precaution is needed to avoid the risk of the water inlet to be blocked and damage the appliance.

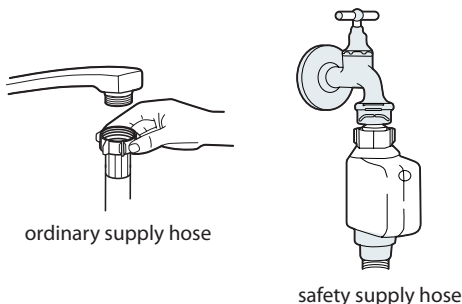

About the safety supply hose

The safety supply hose consists of the double walls. The system guarantees its intervention by blocking the flow of water in case of the supply hose breaking and when the air space between the supply hose itself and the outer corrugated hose is full of water.



WARNING

A hose that attaches to tap can burst if it is installed on the same water line as the dishwasher. If your sink has one, it is recommended that the hose be disconnected and the hole plugged.

How to connect the safety supply hose

1. Pull the safety supply hoses out from storage compartment located at rear of dishwasher.
2. Tighten the screws of the safety supply hose to the faucet with thread 3/4 inch.
3. Turn the water fully on before starting the dishwasher.

How to disconnect the safety supply hose

1. Turn off the water.
2. Unscrew the safety supply hose from the faucet.

Connection Of Drain Hoses

Insert the drain hose into a drain pipe with a minimum diameter of 4 cm, or let it run into the sink, making sure to avoid bending or crimping it. The height of drain pipe must be less than 600 mm. The free end of the hose must not be immersed in water to avoid the back flow of it.

 Please securely fix the drain hose in either position A or position B

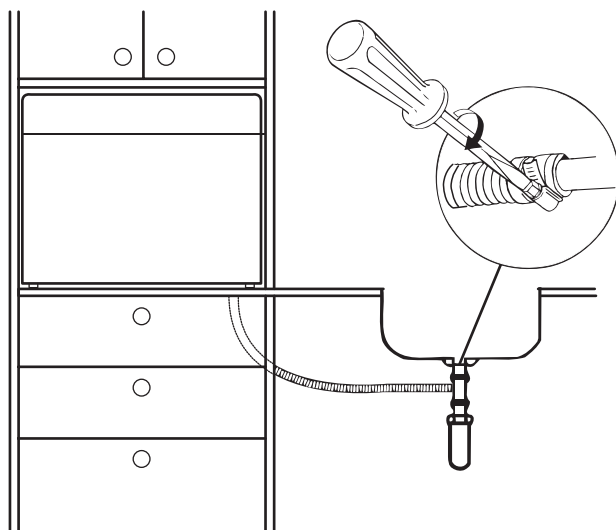
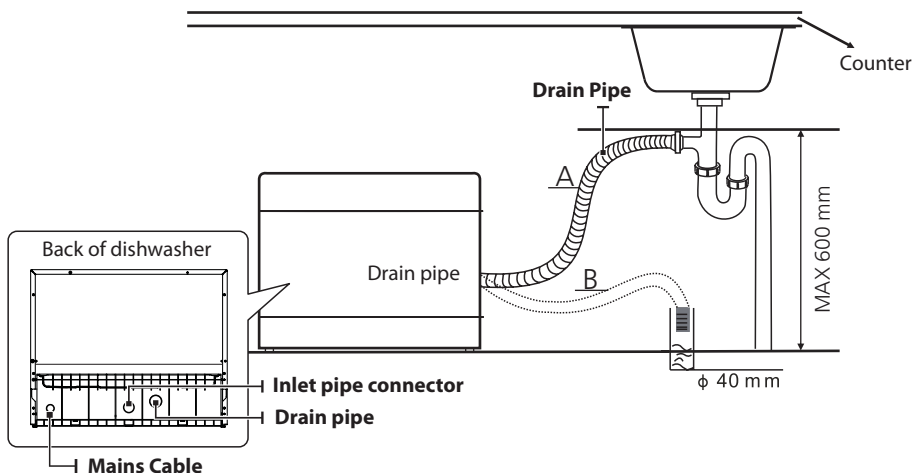

How to drain excess water from hoses

If the connection to the drain pipe is positioned higher than 1000 mm, excess water may remain in the drain hose. It will be necessary to drain excess water from the hose into a bowl or suitable container that is held outside and lower than the sink.

Water outlet

Connect the water drain hose. The drain hose must be correctly fitted to avoid water leaks. Ensure that the water drain hose is not kinked or squashed.

Extension hose

If you need a drain hose extension, make sure to use a similar drain hose.

It must be no longer than 4 meters; otherwise the cleaning effect of the dishwasher could be reduced.

Syphon connection

The waste connection must be at a height less than 1000 mm (maximum) from the bottom of the dishwasher.

Positioning The Appliance

Position the appliance in the desired location. The back should rest against the wall behind it, and the sides, along the adjacent cabinets or walls. The dishwasher is equipped with water supply and drain hoses that can be positioned either to the right or the left sides to facilitate proper installation.

Built-In Installation

Step 1a:

If only the body into cabinets, please make this map the size of the cabinet hole.

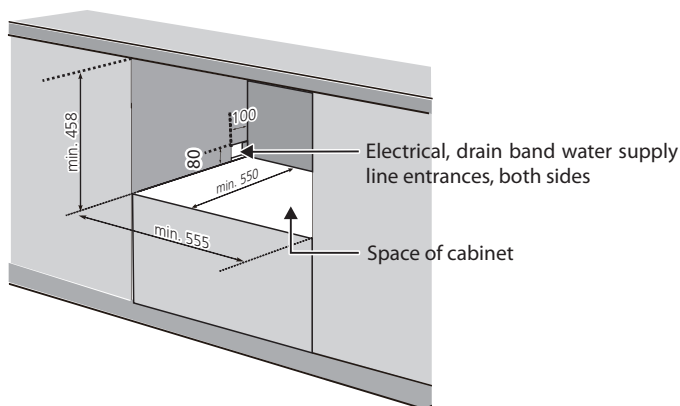

Step 1b:

If the entire decorative panel into the cabinet also, the size of A should be equal to $D + 9.5$; size B should be equal to $C + 6$;

Meanwhile, the cabinet around the inward booster:

both sides of the $(C - 55) / 2 + 3$; C, D and E as the second step within the relevant size decorative panels.

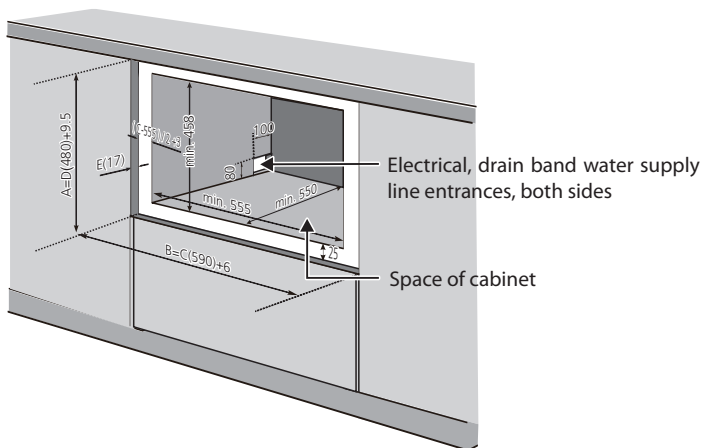

Step 2: Aesthetic panel's dimensions and installation

Weight of the decorative panel should be min 3Kg-max 4Kg.

Dim. A and B could be alterable by handle,

Dim. C, D and E could be alterable by fact,

Dim. E should be in range 16~22mm, besides the appliance assembling decorative panel.

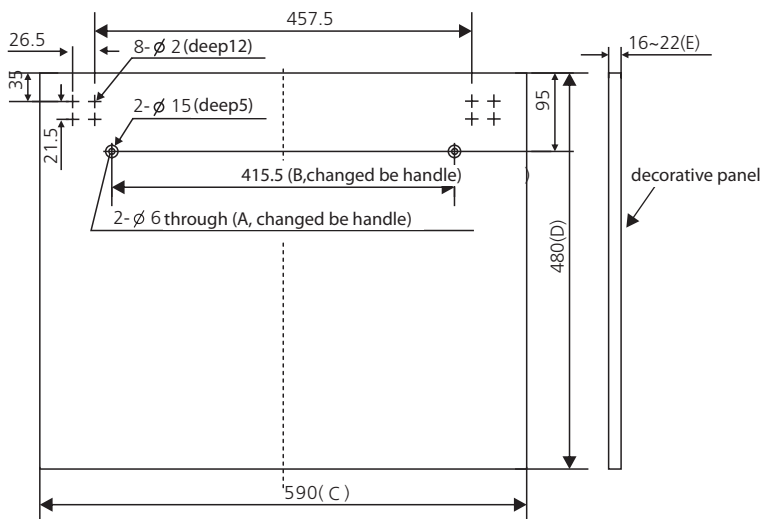

Step 3: Assemble the decorative panel

NOTE:

If the machine with a decorative plate, no this step.

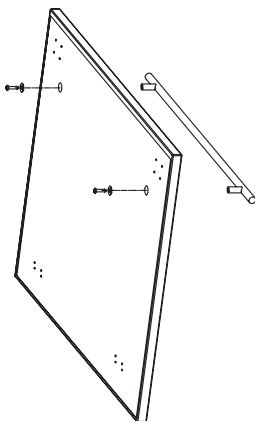

Step 4:

Assemble the decorative door on the dishwasher, as figure. First install screw between the cabinet base board and decorative panel, in all 16; then pull glide from out door groove, case 8-screw between decorative panels and glide.

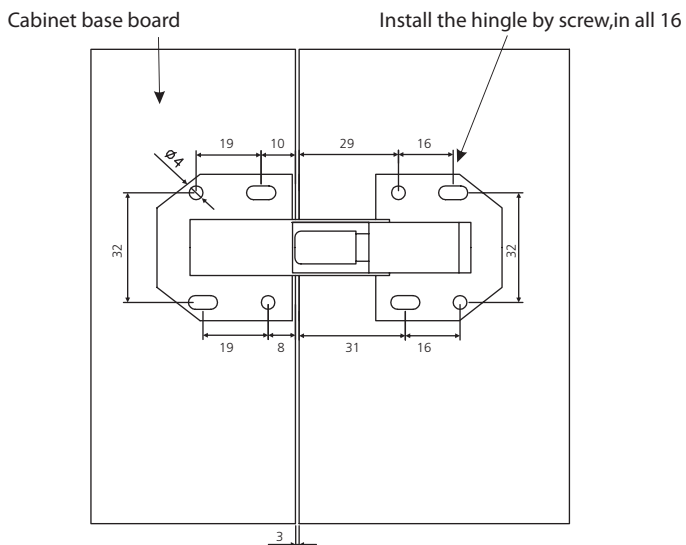

Decorative panel

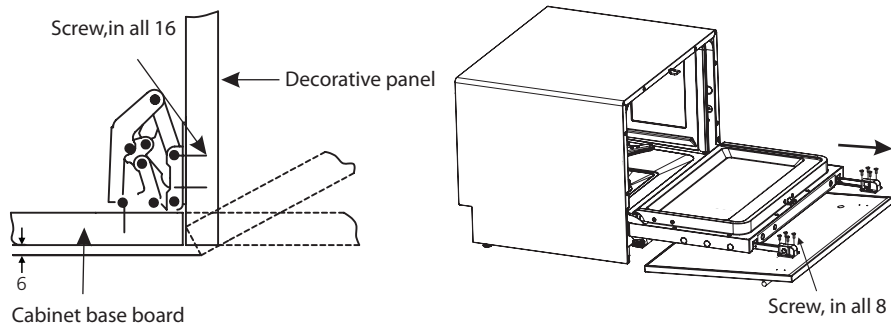

Step 5: Install the adjust screw into the base

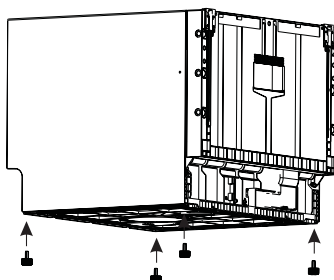

Step 6:

Install the dishwasher in aperture, but not full, as figure, adjust screw, let its bottom align aperture's base, then push dishwasher full.

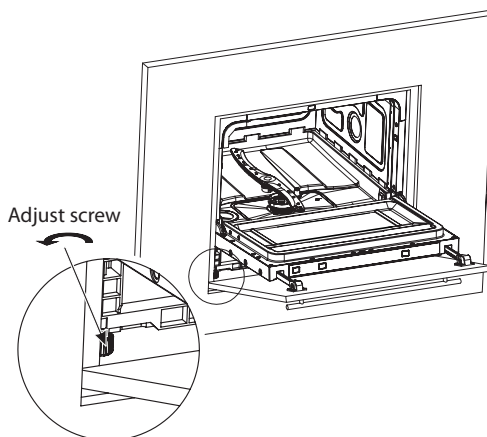

PART 6: TROUBLESHOOTING TIPS

Before Calling For Service

Reviewing the charts on the following pages may save you from calling for service.

Problem	Possible causes	Solution
Dishwasher doesn't start.	Fuse blown, or the circuit breaker tripped.	Replace fuse or reset circuit breaker. Remove any other appliances sharing the same circuit with the dishwasher.
	Power supply is not turned on.	Make sure the dishwasher is turned on and the door is closed securely. Make sure the power cord is properly plugged into the wall socket.
	Door of dishwasher not properly closed.	Make sure to close the door properly and latch it.
Water not pumped from dishwasher.	Kink in drain hose.	Check drain hose.
	Filter clogged.	Check the coarse filter. (see section titled "Internal Care").
	Kitchen sink clogged.	Check the kitchen sink to make sure it is draining well. If the problem is the kitchen sink that is not draining, you may need a plumber rather than a serviceman for dishwashers.
Foam in the tub.	Improper detergent.	Use only the special dishwasher detergent to avoid suds. If this occurred, open the dishwasher and let suds evaporate. Add 1 gallon of cold water to the tub. Close and latch the dishwasher, then Start any wash cycle to drain out the water. Repeat if necessary.
	Spilled rinse aid.	Always wipe up rinse aid spills immediately.
Stained tub interior.	Detergent with colourant may have been used.	Make sure that the detergent has no colourant.
White film on inside surface.	Hard water minerals.	To clean the interior, use the damp soft cloth with dishwasher detergent and wear rubber gloves. Never use any other cleaner than dishwasher detergent for the risk of foaming or suds.

Problem	Possible causes	Solution
There are rust stains on cutlery.	The affected items are not corrosion resistant.	Avoid washing items that are not corrosion resistant in the dishwasher.
	A program was not run after dishwasher salt was added. Traces of salt have gotten into the wash cycle.	Always run the quick wash program. Without any crockery in the dishwasher and without selecting the Turbo function (if present), after adding dishwasher salt.
	The lid of the softer is loose.	Check the lip. Ensure the fix is fine.
Knocking noise in the wash cabinet.	The spray arm is knocking against an item in a basket.	Interrupt the program, and rearrange the items which are obstructing the spray arm.
Rattling noise in the wash cabinet.	Item of crockery are loose in the wash cabinet.	Interrupt the program, and rearrange the items of crockery.
Knocking noise in the water pipes.	This may be caused by on-site installation or the cross-section of the piping.	This has no influence on the dishwasher function. If in doubt, contact a qualified plumber.
The dishes are not clean.	The dishes were not loaded correctly.	See "Preparing And Loading Dishes".
	The program was not powerful enough.	Select a more intensive program.
	Not enough detergent was dispensed.	Use more detergent, or change your detergent.
	Item are blocking the path of spray arms.	Rearrange the items so that the spray can rotate freely.
	The filter combination in the base of wash cabinet is not clean or is not correctly fitted. This may cause the spray arm jets to get blocked.	Clean and/or fit the filter correctly. Clean the spray arm jets.

Problem	Possible causes	Solution
Cloudiness on glassware.	Combination of soft water and too much detergent.	Use less detergent if you have soft water and select a shorter cycle to wash the glassware and to get them clean.
Black or grey marks on dishes.	Aluminium utensils have rubbed against dishes.	Use a mild abrasive cleaner to eliminate those marks.
Detergent left in dispenser cups.	Dishes block detergent dispenser cups.	Re-loading the dishes properly.
The dishes are not drying.	Improper loading.	Use gloves if detergent residue can be found on dishes to avoid skin irritations.
	Dishes are removed too soon.	Do not empty your dishwasher immediately after washing. Open the door slightly so that the steam can escape. Begin unloading the dishwasher only once the dishes are barely warm to the touch. Empty the low basket first. This prevents water from dropping off dishes in the upper basket.
	Wrong program has been selected.	In short programs the washing temperature is lower. This also lowers cleaning performance. Choose a program with a long washing time.
	Use of cutlery with a low-quality coating.	Water drainage is more difficult with these items. Cutlery or dishes of this type are not suitable for washing in the dishwasher.



WARNING

Self-repair or non-professional repair may cause serious risks to the safety of the user of the appliance and impact warranty.

Availability Of Spare Parts

- **Seven years after placing the last unit of the model on the market:**

Motor, circulation and drain pump, heaters and heating elements, including heat pumps (separately or bundled), piping and related equipment including all hoses, valves, filters and aqua stops, structural and interior parts related to door assemblies (separately or bundled), printed circuit boards, electronic displays, pressure switches, thermostats and sensors, software and firmware including reset software.

- **Ten years after placing the last unit of the model on the market:**

Door hinge and seals, other seals, spray arms, drain filters, interior racks and plastic peripherals such as baskets and lids.

PART 7: LOADING THE BASKETS ACCORDING TO EN60436

Loading the dishwasher to its full capacity will contribute to energy and water savings.

1. Basket:

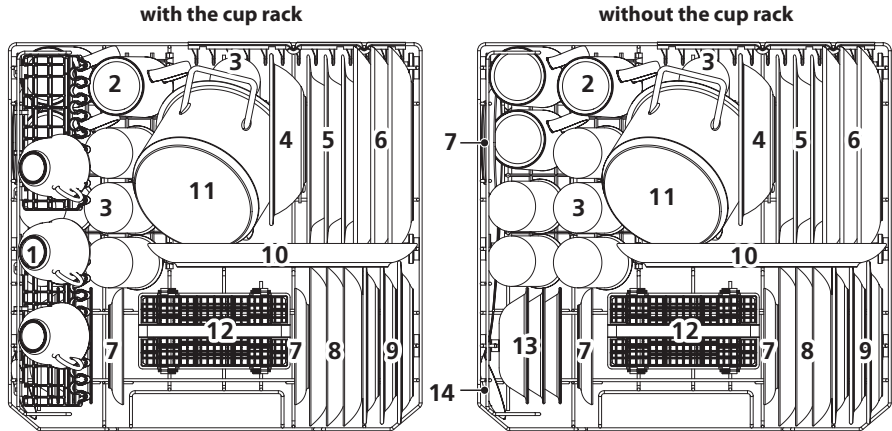

Number	Item
1	Cups
2	Mugs
3	Glasses
4	Melamine bowl
5	Soup plates
6	Dinner plates
7	Saucers
8	Dessert dishes
9	Melamine dessert plates
10	Oval platter
11	Small pot
12	Cutlery basket
13	Dessert bowls
14	Serving spoon

2. Cutlery basket:

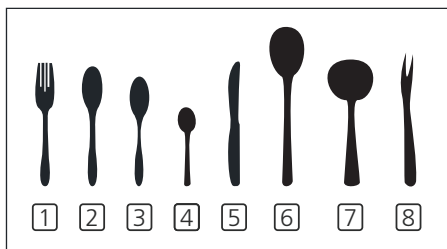
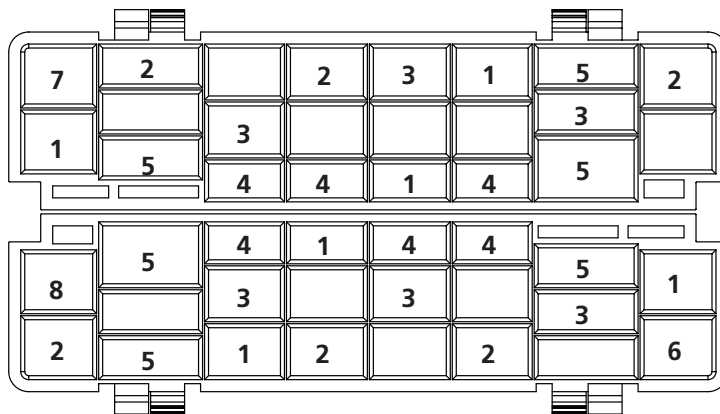

Number	Item
1	Forks
2	Soup spoons
3	Dessert spoons
4	Teaspoons
5	Knives
6	Serving spoons
7	Gravy ladles
8	Serving forks

Information for comparability tests in accordance with EN60436

- Capacity: 6 place settings
- Program: ECO
- Rinse aid setting: Max
- Softener setting: H4

PART 8: QUICK USER GUIDE

Please read the corresponding content on the instruction manual for detailed operating method.

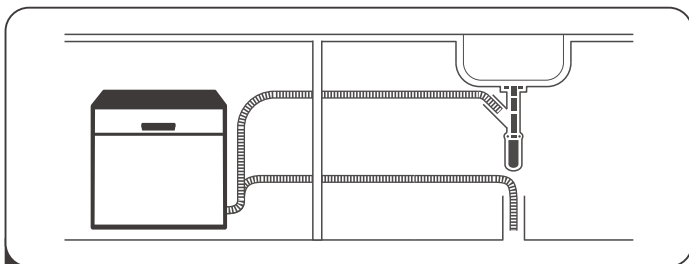

- 1 Install the dishwasher
(Please check the section "INSTALLATION INSTRUCTION")



- 2 Remove larger residue from dishes.
Avoid pre-rinsing.

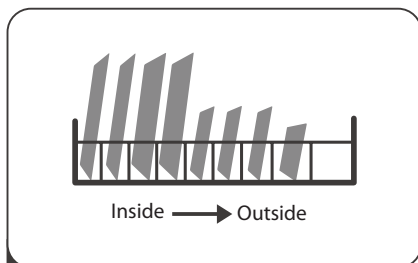

- 3 Load the baskets.

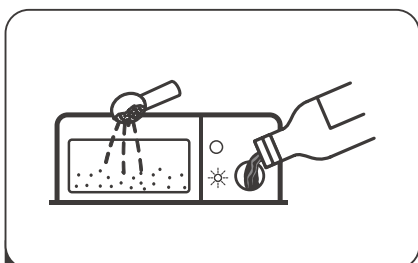

- 4 Fill the dispenser with detergent and rinse aid.

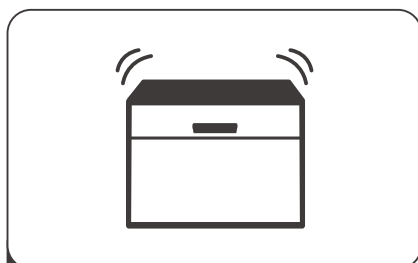

- 5 Select a suitable programme and start the dishwasher.

PART 9: USING YOUR DISHWASHER



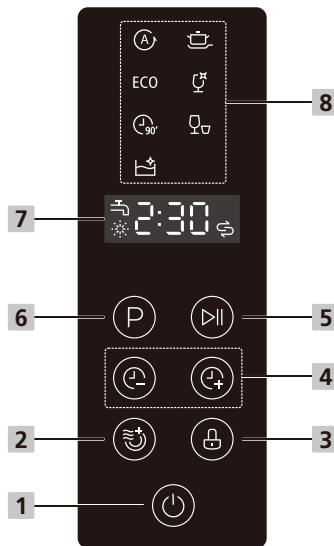









Control Panel



Operation (Button)

1 Power	Press this button to turn on the dishwasher, the screen lights up.
2 Extra Drying	For better drying result. (It can only be used with Intensive, ECO, Glass, 90 min)
3 Child lock	This option allows you to lock the buttons on the control panel, so children cannot accidentally start the dishwasher by pressing the buttons on the panel. Only the Power remains active. To lock or unlock the buttons on the control panel, press and hold the button for 3 seconds.
4 Delay+/-	Press the "+" button to add the delay time or press the "-" button to decrease the delay time, maximum 24 hours delay can be defined.
5 Start/Pause	To start the selected washing program or pause it when the dishwasher is working.
6 Program	Press this button to select the appropriate washing programme, the programme indicator will be lit.

Display

7 Screen	<p> Rinse Aid If the  indicator is lit, it means the dishwasher is low on dishwasher rinse aid and requires a refill.</p> <p> Salt If the  indicator is lit, it means the dishwasher is low on dishwasher salt and needs to be refilled.</p> <p> Water Faucet If the  indicator is lit, it means the water faucet closed.</p>
8 Program indicators	<p> To show the reminding time and delay time, error codes etc.</p> <p> Auto Light to heavily soiled daily used items, automatic detection of the amount of soils.</p> <p> Intensive For heaviest soiled crockery, and normally soiled pots, pans, dishes etc. With dried-on food.</p> <p>ECO ECO This is standard program, it is suitable to clean normally soiled tableware and it is the most efficient program in terms of its combined energy and water consumption for that type of tableware.</p> <p> Glass For lightly soiled crockery and glass.</p> <p> 90 min For normally soiled loads that need quick wash.</p> <p> Rapid A shorter wash for lightly soiled loads that do not need drying.</p> <p> Self-Cleaning This program provides an effective cleaning of the dishwasher itself.</p>

Water Softener

The water softener must be set manually, using the water hardness dial.

The water softener is designed to remove minerals and salts from the water, which would have a detrimental or adverse effect on the operation of the appliance.

The more minerals there are, the harder your water is.

The softener should be adjusted according to the hardness of the water in your area.

Your local Water Authority can advise you on the hardness of the water in your area.

Adjusting salt consumption

The dishwasher is designed to allow for adjustment in the amount of salt consumed based on the hardness of the water used. This is intended to optimise and customise the level of salt consumption.

Please follow the steps below for adjustment in salt consumption.

1. Close the door, switch on the appliance.
2. Within 60 seconds after the appliance was switched on, press the Programme button for more than 5 seconds to start the water softener setting mode.
3. Press the Program button again to select the proper setting according to your local environment, the setting will change in the following sequence:
H1->H2->H3->H4->H5->H6;
4. Without any operation in five seconds or press the Power button to end the setting mode, the setting is memorized by the programme.

WATER HARDNESS		Setting on the water softener	Digital display stalls	Regeneration occurs every X program sequence ³⁾
° dH ¹⁾	Mmol/l ²⁾			
0 - 5	0 - 0.9	1	H1	No regeneration
6 - 11	1.0 - 2.0	2	H2	10
12 - 17	2.1 - 3.0	3	H3	5
18 - 22	3.1 - 4.0	4 *	H4	3
23 - 34	4.1 - 6.1	5	H5	2
35 - 45	6.2 - 8.0	6	H6	1

- 1) German degree of measurement for the water hardness
- 2) Millimol, international unit for water hardness
- 3) Every cycle with a regeneration operation consumes additional 2.0 litres of water, the energy consumption increases by 0.02 kWh and the program extends by 4 minutes.

* factory setting

Please check the section “Loading The Salt Into The Softener”, if your dishwasher lacks salt.

NOTE

If your model does not have any water softener, you may skip this section.

Water Softener

The hardness of the water varies from place to place. If hard water is used in the dishwasher, deposits will form on the dishes and utensils.

The appliance is equipped with a special softener that uses a salt container specifically designed to eliminate lime and minerals from the water.

Preparing And Loading Dishes

- Consider buying utensils which are identified as dishwasher-proof.
- For particular items, select a program with the lowest possible temperature.
- To prevent damage, do not take glass and cutlery out of the dishwasher immediately after the program has ended.

For washing the following cutlery/dishes

Are not suitable

- Cutlery with wooden, horn china or mother-of-pearl handles
- Plastic items that are not heat resistant
- Older cutlery with glued parts that are not temperature resistant
- Bonded cutlery items or dishes
- Pewter or cooper items
- Crystal glass
- Steel items subject to rusting
- Wooden platters
- Items made from synthetic fibres

Are of limited suitability

- Some types of glasses can become dull after a large number of washes
- Silver and aluminum parts have a tendency to discolour during washing
- Glazed patterns may fade if machine washed frequently

Recommendations for loading the dishwasher

Scrape off any large amounts of leftover food. Soften remnants of burnt food in pans. It is not necessary to rinse the dishes under running water.

For best performance of the dishwasher, follow these loading guidelines.

(Features and appearance of baskets and cutlery baskets may vary from your model.)

Place objects in the dishwasher in the following way:

- Items such as cups, glasses, pots/pans, etc. must face downwards.
- Curved items, or ones with recesses, should be loaded aslant so that water can run off.
- All utensils are stacked securely and can not tip over.
- All utensils are placed in the way that the spray arms can rotate freely during washing.
- Load hollow items such as cups, glasses, pans etc. With the opening facing downwards so that water cannot collect in the container or a deep base.
- Dishes and items of cutlery must not lie inside one another, or cover each other.
- To avoid damage, glasses should not touch one another.
- The upper basket is designed to hold more delicate and lighter dishware such as glasses, coffee and tea cups.
- Long bladed knives stored in an upright position are a potential hazard!
- Long and / or sharp items of cutlery such as carving knives must be positioned horizontally in the upper basket.
- Please do not overload your dishwasher. This is important for good results and for reasonable consumption of energy.

NOTE

Very small items should not be washed in the dishwasher as they could easily fall out of the basket.



WARNING



Items will be hot! To prevent damage, do not take glass and cutlery out of the dishwasher for around 15 minutes after the program has ended.

Loading the basket

All tableware can't be placed face up, in order to improve the cleaning area and washing performance, it is recommended to place the dirty side towards the spray arm.

Please don't let tableware out of basket bottom to make sure not block the moving of the spray arm.

The maximum diameter advised for plates in front of the detergent dispenser is of 19 cm, this not to hamper the opening of it.

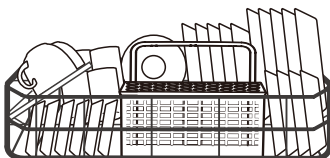

Loading the cutlery basket

For personal safety and a top quality cleaning, place the silverware in the basket making sure that:

- They do not nest together.
- Silverware is placed with the handles-down.
- But place knives and other potentially dangerous utensils are placed handles-up.

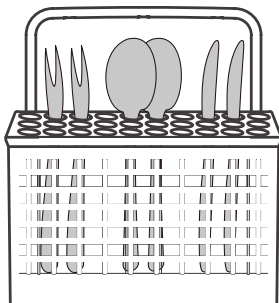

WARNING



Do not let any item extend through the bottom.
Always load sharp utensils with the sharp point down!

For the best washing effect, please load the baskets refer to standard loading options.

Function Of The Rinse Aid And Detergent

The rinse aid is released during the final rinse to prevent water from forming droplets on your dishes, which can leave spots and streaks. It also improves drying by allowing water to roll off the dishes. Your dishwasher is designed to use liquid rinse aids.



WARNING

Only use branded rinse aid for dishwasher. Never fill the rinse aid dispenser with any other substances (e.g. Dishwasher cleaning agent, liquid detergent). This would damage the appliance.

When to refill the rinse aid dispenser

Unless the rinse-aid warning light () on the control panel is on, you can always estimate the amount from the color of the optical level indicator located next to the cap. When the rinse-aid container is full, the indicator will be fully dark. The size of the dark dot decreases as the rinse-aid diminishes. You should never let the rinse aid level be less than 1/4 full.

As the rinse aid diminishes, the size of the black dot on the rinse aid level indicator changes, as illustrated below.

Full

3/4 full

1/2 full

1/4 full

Empty

Function of detergent

The chemical ingredients that compose the detergent are necessary to remove, crush and dispense all dirt out of the dishwasher. Most of the commercial quality detergents are suitable for this purpose.



WARNING

• Proper Use of Detergent

Use only detergent specifically made for dishwashers use. Keep your detergent fresh and dry. Do not fill detergent into the dispenser until you are ready to start the dishwasher.



• **Dishwasher detergent is corrosive! Keep dishwasher detergent out of the reach of children.**

Filling The Rinse Aid Reservoir

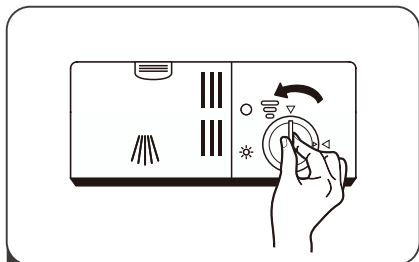

- 1 Remove the rinse aid reservoir cap by rotating it counterclockwise.

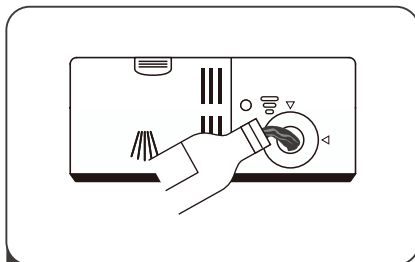

- 2 Carefully pour in the rinse aid into the dispenser, whilst avoiding it to overflow.

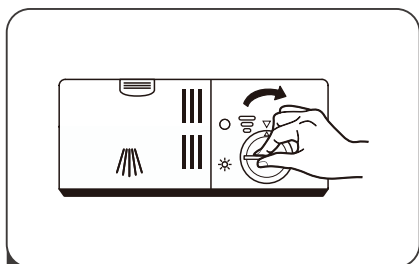

- 3 Close the rinse aid reservoir cap by rotating it clockwise.

NOTE

Clean up any spilled rinse aid with an absorbent cloth to avoid excessive foaming during the next wash.

Adjusting the rinse aid reservoir

Remove the rinse aid reservoir cap. Turn the rinse aid indicator dial to a number. The higher the number, the more rinse aid the dishwasher uses.

If the dishes are not drying properly or are spotted, adjust the dial to the next higher number until your dishes are spot-free.

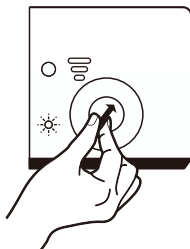

Filling The Detergent Dispenser

Push latch to open

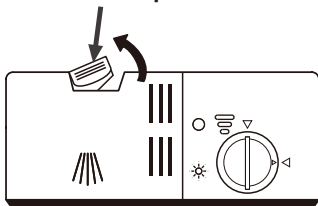

- 1 Press the release latch on the detergent dispenser to open the cover.

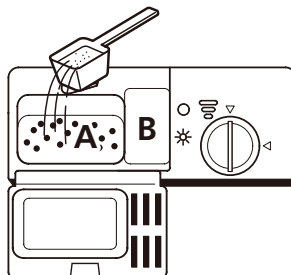

- 2 Add detergent into the larger cavity (A) for main wash. For more heavily soiled wash loads, also add some detergent into the smaller cavity (B) for release during pre-wash.

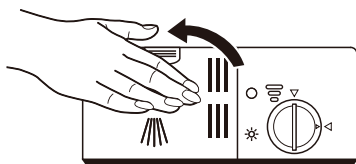

- 3 Close the cover and press on it until it locks into place.

NOTE







- Please observe the manufacturer's recommendations on the detergent packaging.

PART 10: PROGRAMMING THE DISHWASHER

Wash Cycle Table

The table below shows which programs are best for the levels of food residue on them and how much detergent is needed. It also shows various information about the programs. Consumption values and program duration are only indicative except for the ECO program.

(●) indicates that the program uses rinse aid in the last rinse.

Program	Description Of Cycle	Detergent Pre/ Main Wash	Running Time (min)	Energy (kWh)	Water (L)	Rinse Aid
 Auto	Pre-wash (45°C) Wash (50-65°C) Rinse Rinse Rinse (70°C) Drying	3/15g 1 tab	100-175	0.700- 0.900	6.0-10.0	●
 Universal	Pre-wash (50°C) Wash (70°C) Rinse Rinse Rinse (70°C) Drying	3/15g 1 tab	140	0.894	9.6	●
ECO (*EN50242)	Pre-wash Wash (45°C) Rinse (65°C) Drying	3/15g 1 tab	230	0.609	6.5	●
 Glass	Wash (45°C) Rinse Rinse (60°C) Drying	18g 1 tab	75	0.435	5.8	●
 90 Min	Wash (65°C) Rinse Rinse Rinse (70°C) Drying	18g 1 tab	90	0.785	6.6	●
 Rapid	Wash (40°C) Rinse Rinse	15g 1 tab	30	0.244	5.8	○
 Self-cleaning	Wash (70°C) Rinse Rinse (65°C) Drying	18g 1 tab	80	0.700	5.6	●







NOTE

ECO : The ECO program is suitable to clean normally soiled tableware, that for this use, it is the most efficient program in terms of its combined energy and water consumption, and it is used to assess compliance with the EU ecodesign legislation.
(*EN50242)

Wash Cycle Table

The table below shows which programs are best for the levels of food residue on them and how much detergent is needed. It also show various information about the programs. Consumption values and program duration are only indicative except for ECO program.

(●) indicates that the program uses rinse aid in the last rinse.

Program	Description Of Cycle	Detergent Pre/ Main Wash	Running Time (min)	Energy (kWh)	Water (L)	Rinse Aid
 Auto	Pre-wash (45°C) Wash (50-65°C) Rinse Rinse Rinse (70°C) Drying	4/10g 1 tab	100-175	0.700- 0.900	6.0-10.0	●
 Universal	Pre-wash (50°C) Wash (70°C) Rinse Rinse Rinse (70°C) Drying	4/10g 1 tab	140	0.894	9.6	●
ECO (*EN60436)	Pre-wash Wash (45°C) Rinse (65°C) Drying	4/10g 1 tab	230	0.613	6.5	●
 Glass	Wash (45°C) Rinse Rinse (60°C) Drying	14g 1 tab	75	0.435	5.8	●
 90 Min	Wash (65°C) Rinse Rinse Rinse (70°C) Drying	14g 1 tab	90	0.785	6.6	●
 Rapid	Wash (40°C) Rinse Rinse	12g 1 tab	30	0.244	5.8	○
 Self-cleaning	Wash (70°C) Rinse Rinse (65°C) Drying	14g 1 tab	80	0.700	5.6	●

NOTE

ECO : The ECO program is suitable to clean normally soiled tableware, that for this use, it is the most efficient program in terms of its combined energy and water consumption, and it is used to assess compliance with the EU ecodesign legislation.
(*EN60436)

Saving Energy

1. Pre-rinsing of tableware items leads to increased water and energy consumption and is not recommended.
2. Washing tableware in a household dishwasher usually consumes less energy and water in the use phase than hand dishwashing when the household dishwasher is used according to the instructions.

Starting A Programme

1. Draw out the basket, load the dishes and push them back.
2. Pour in the detergent.
3. Insert the plug into the socket. The power supply refer to last page "Product fiche".
Make sure that the water supply is turned on to full pressure.
4. Close the door, press the Power button, to switch on the machine.
5. Choose a program, the response light will turn on. Then press the Start/Pause button, the dishwasher will start its cycle.

Changing The Program Mid-cycle

A programme can only be changed if it has been running only for a short period of time, otherwise the detergent may have already been released or the the wash water with detergent has already been drained. If this is the case, the dishwasher needs to be reset and the detergent dispenser must be refilled. To reset the dishwasher, follow the instructions below:

1. Press the Start/Pause button to pause the washing.
2. Press Program button for more than 3 seconds, the machine will be in program selection mode.
3. Press the Program button to select the desired program.
4. Press the Start/Pause button, after 1 seconds, the dishwasher will start.

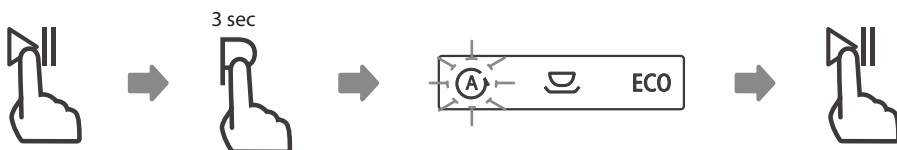

Forget To Add A Dish?

A forgotten dish can be added any time before the detergent dispenser opens. If this is the case, follow the instructions below:

1. Press the Start/Pause button to pause the washing.
2. Wait 5 seconds then open the door.
3. Add the forgotten dishes.
4. Close the door.
5. Press the Start/Pause button after 10 seconds, the dishwasher will start.

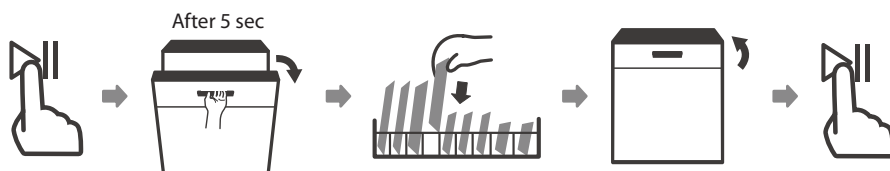

It is dangerous to open the door mid-cycle, as hot steam may scald you.

PART 11: ERROR CODES

If there is a malfunction the dishwasher will display an error code. The following table shows possible error codes and their causes.

Codes	Meanings	Possible Causes
E1	Longer inlet time.	Faucets is not opened, or water intake is restricted, or water pressure is too low.
E3	Not reaching required temperature.	Malfunction of heating element.
E4	Overflow.	Some element of dishwasher leaks.
Ed	Failure of communication between main circuit board with display circuit board.	Open circuit or break wiring for the communication.



WARNING

- If overflow occurs, turn off the main water supply before calling a service.
- If there is water in the base pan because of an overflow or small leak, the water should be removed before restarting the dishwasher.
- If there is an error code that cannot be solved, please request professional assistance.

PART 12: TECHNICAL INFORMATION

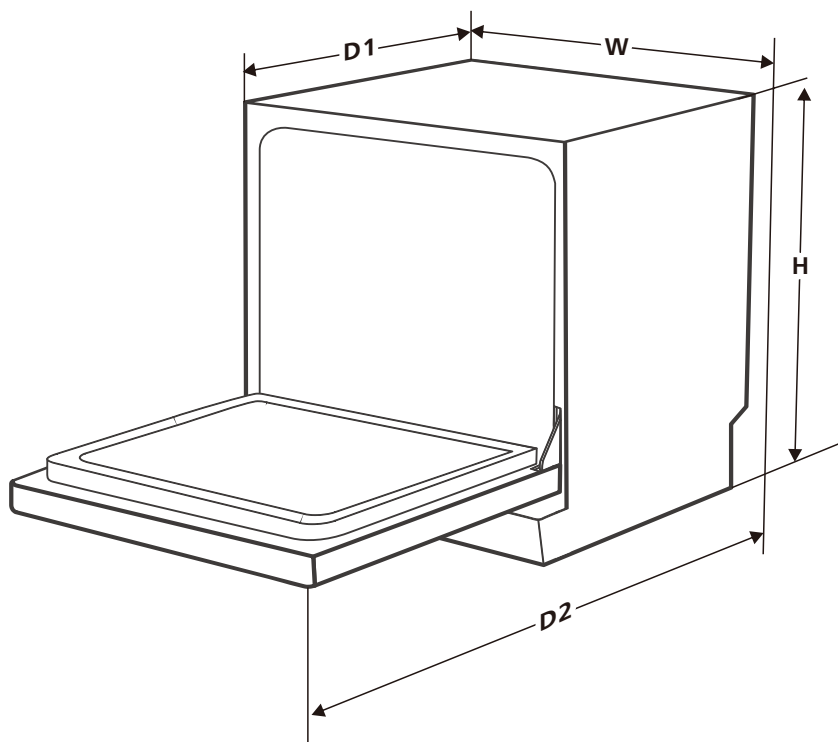

Height (H)	438mm
Width (W)	550mm
Depth (D1)	500mm (with the door closed)
Depth (D2)	812mm (with the door opened 90°)

PART 13: PRODUCT INFORMATION SHEET

Product Information Sheet

PHILCO 

COMMISSION DELEGATED REGULATION (EU) 2019/2016

Supplier's name or trademark: PHILCO

Supplier's address: U Sanitasu 1621, Říčany 251 01, CZ

Model identifier: PDT 67 DF

General product parameters: Table dishwasher

Parameter	Value	Parameter	Value	
Rated capacity (kg)	6	Dimensions in cm	Height	44
			Width	55
			Depth	50
EEI _w	61.9	Energy efficiency class *	F	
Cleaning performance index	1.125	Drying performance index	1.065	
Energy consumption in kWh [per cycle], based on the eco programme using cold water fill. Actual energy consumption will depend on how the appliance is used.	0.613	Water consumption in litres [per cycle], based on the eco programme. Actual water consumption will depend on how the appliance is used and on the hardness of the water.	6.5	
Programme duration (h:min)	3:50	Type	Free-standing	
Airborne acoustical noise emissions (dB(A) re 1 pW)	49	Airborne acoustical noise emission class	C	
Off-mode (W)	0.49	Standby mode (W)	-	
Delay start (W) (if applicable)	1.00	Networked standby (W) (if applicable)	-	

Minimum duration of the guarantee offered by the supplier: 24 months

Additional information:

Weblink to the supplier's website, where the information in point 6 of Annex II to Commission Regulation (EU) 2019/2022 is found: www.philco.cz

* A (highest efficiency) to G (lowest efficiency)

TECHNICAL INFORMATION

Technical information can be found on the type plate on the inside of the appliance and on the energy label. The QR code, on the supplied energy label, contains a link to register the appliance in the EU Eprel database. Keep the energy label, the instructions for use, together with other documents supplied with the device.

TESTING INFORMATION

The delivered device is in accordance with EcoDesign and EN50564:2011. Air access requirements for proper operation of the device, the minimum distance from the wall and the dimensions of the device are part of this manual. If you have any further questions, please contact the manufacturer.

CUSTOMER CARE AND SERVICE

Always use original spare parts.

Model name and serial number can be found on the rating plate. Position of rating plate can be changed without notice.

The original spare parts for some specific components are available for a minimum of 7 or 10 years, based on the type of component, from the placing on the market of the last unit of the model.

When contacting our authorized service, have the model designation, serial number and defect description available.

To download documents, visit www.philco.cz.

To report a defect and obtain additional service information, visit <https://philco.cz/podpora-a-servis>.

Subject to change without notice.

INSTRUCTIONS AND INFORMATION REGARDING THE DISPOSAL OF USED PACKAGING MATERIALS

Dispose of packaging material at a public waste disposal site.

DISPOSAL OF USED ELECTRICAL AND ELECTRONIC APPLIANCES



The meaning of the symbol on the product, its accessory or packaging indicates that this product shall not be treated as household waste. Please, dispose of this product at your applicable collection point for the recycling of electrical & electronic equipment waste. Alternatively in some states of the European Union or other European states you may return your products to your local retailer when buying an equivalent new product. The correct disposal of this product will help save valuable natural resources and help in preventing the potential negative impact on the environment and human health, which could be caused as a result of improper liquidation of waste. Please ask your local authorities or the nearest waste collection centre for further details. The improper disposal of this type of waste may fall subject to national regulations for fines.

For business entities in the European Union

If you wish to dispose of an electrical or electronic device, request the necessary information from your seller or supplier.

Disposal in other countries outside the European Union

If you wish to dispose of this product, request the necessary information about the correct disposal method from local government departments or from your seller.



This product meets all the basic EU regulation requirements that relate to it.

Changes to the text, design and technical specifications may occur without prior notice and we reserve the right to make these changes.

Original of this user manual is in czech language.

Výrobce/Manufacturer:
Fast ČR, a.s.
U Sanítasu 1621
Říčany 251 01, CZECH REPUBLIC

Importer to SK:
FAST PLUS, a.s.
Na pántoch 18, 831 06 Bratislava
SLOVAKIA

Importer to PL:
FAST Poland Sp. z o. o.
Ul. Kwietniowa 36, 05-090 Wypędy
POLAND

Importer to HU:
FAST HUNGARY Kft.
Kántor út 10., 2310 Szigetszentmiklós
HUNGARY

PHILCO[®] 

**is a pending or registered trademark of Electrolux
Home Products, Inc. and used under a license from
Electrolux Home Products, Inc.**