

**brother**

# Operation Manual

## Compact Overlock Machine

Product Code: 884-B02 / B03

---

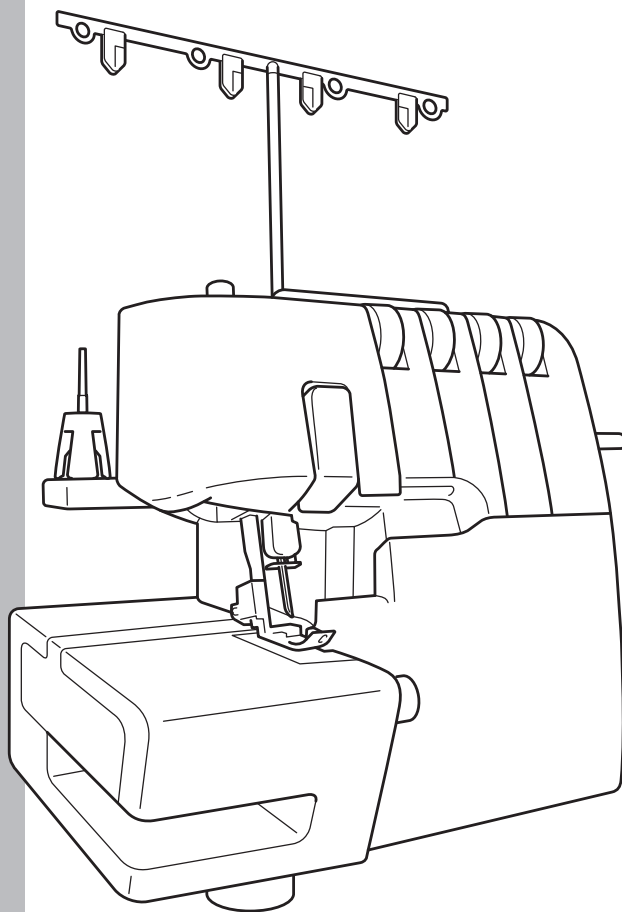

Be sure to read this document before using the machine.  
We recommend that you keep this document nearby for future reference.

# IMPORTANT SAFETY INSTRUCTIONS

When using the sewing machine, basic safety precautions should always be followed, including the following. Read all instructions before using this machine.

## DANGER

**To reduce the risk of electric shock.**

The sewing machine should never be left unattended when plugged in. Always unplug this sewing machine from the electrical outlet immediately after using and before cleaning.

## WARNING

**To reduce the risk of burns, fire, electric shock, or injury to persons.**

1. Do not allow to be used as a toy. Close attention is necessary when the sewing machine is used by or near children.
2. Use this sewing machine only for its intended use as described in this manual. Use only accessories recommended by the manufacturer as contained in this manual.
3. Never operate this sewing machine if it has a damaged cord or plug, if it is not working properly, if it has been dropped or damaged, or dropped into water. Return the sewing machine to the nearest authorized dealer or service center for examination, repair, electrical or mechanical adjustment.
4. Never operate the sewing machine with any air openings blocked. Keep ventilation openings of the sewing machine and foot controller free from the accumulation of lint, dust, and loose cloth.
5. Never drop or insert any object into any openings.
6. Do not use outdoors.
7. Do not operate where aerosol (spray) products are being used or where oxygen is being administered.
8. To disconnect, turn the main switch to the symbol "O" position which represents off, then remove plug from outlet.
9. Do not unplug by pulling on cord. To unplug, grasp the plug, not the cord.
10. Keep fingers away from all moving parts. Special care is required around the sewing machine needle.
11. Always use the proper needle plate. The wrong plate can cause the needle to break.
12. Do not use bent needles.
13. Do not pull or push fabric while stitching. It may deflect the needle causing it to break.
14. Switch the sewing machine to the symbol "O" position when making any adjustments in the needle area, such as threading needle, changing needle, or changing presser foot, etc.
15. Always unplug the sewing machine from the electrical outlet when removing covers, lubricating, or when making any other user servicing adjustments mentioned in the instruction manual.
16. Electrical Hazards:
  - This machine should be connected to an AC power source within the range indicated on the rating label. Do not connect it to a DC power source or inverter. If you are not sure what kind of power source you have, contact a qualified electrician.
  - This machine is approved for use in the country of purchase only.

17. This sewing machine is not intended for use by young children or infirm persons without supervision.
18. Young children should be supervised to ensure that they do not play with this sewing machine.
19. Do not disassemble the machine.
20. If the LED light unit (light-emitting diode) is damaged, it must be replaced by authorized dealer.

## CAUTION

**To use the machine safely**

1. (For U.S.A. only)

This appliance has a polarized plug (one blade wider than the other) to reduce the risk of electric shock, this plug is intended to fit in a polarized outlet only one way.

If the plug does not fit fully in the outlet, reverse the plug. If it still does not fit, contact a qualified electrician to install the proper outlet. Do not modify the plug in any way.
2. Make sure you watch the needles carefully while you are sewing. Do not touch the hand wheel, needles, knives, or other moving parts.
3. Turn off the main power and unplug the cord in the following circumstances:
  - When you have stopped using the machine
  - When you are replacing or removing the needle or any other part
  - If there is a power failure while you are using the machine
  - If you are checking or cleaning the machine
  - Leaving the machine unattended
4. Do not store anything on the foot controller.
5. Fully plug the machine directly into the wall. Do not use extension cords.
6. If water is dropped on the machine, unplug the machine immediately, and contact your local authorized dealer.
7. Do not put furniture on the cord.
8. Do not bend the cord, or pull on the cord to unplug.
9. Do not touch the cord with wet hands.
10. Place the machine near to the wall outlet.
11. Do not place the machine on an unstable surface.
12. Do not put on the soft cover.
13. If you notice any abnormal sound or condition, consult your local authorized dealer.

**To give your machine a longer life**

1. Do not store this machine in direct sunlight or in high humidity conditions. Do not use or store the machine near a heater, iron, halogen lamp or other hot object.
2. Use only mild soaps or detergents to clean the case. Benzene, thinner, and scouring powders can damage the case and machine, and should never be used.
3. Do not drop or hit the machine.
4. Always consult this manual before you replace or fit the presser foot, needle, or any other parts to make sure you fit them correctly.

**To repair or adjust the machine**

If the machine breaks down or needs adjustment, first follow the troubleshooting table to inspect and adjust the machine yourself. If the problem persists, consult your local authorized dealer.

# SAVE THESE INSTRUCTIONS

**This machine is intended for household use.**

## FOR USERS IN COUNTRIES EXCEPT CENELEC COUNTRIES

This appliance is not intended for use by persons (including children) with reduced physical, sensory or mental capabilities, or lack of experience and knowledge, unless they have been given supervision or instruction concerning use of the appliance by a person responsible for their safety. Children should be supervised to ensure that they do not play with the appliance.

## FOR USERS IN CENELEC COUNTRIES

This appliance can be used by children aged from 8 years and above and persons with reduced physical, sensory or mental capabilities or lack of experience and knowledge if they have been given supervision or instruction concerning use of the appliance in a safe way and understand the hazards involved. Children shall not play with the appliance. Cleaning and user maintenance shall not be made by children without supervision.

## **!** CAUTION

---

When leaving this sewing machine unattended, the main power and light switch of the machine must be switched off or the plug must be removed from the socket-outlet.

When servicing the sewing machine, or when removing covers, the machine or the electrical set must be disconnected from the supply by removing the plug from the socket-outlet.

---

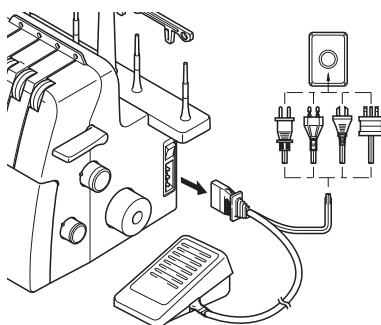

## FOR USERS IN THE UK, EIRE, MALTA AND CYPRUS ONLY

### IMPORTANT

- In the event of replacing the plug fuse, use a fuse approved by ASTA to BS 1362, i.e. carrying the  mark, rating as marked on plug.
- Always replace the fuse cover. Never use plugs with the fuse cover omitted.
- If the available electrical outlet is not suitable for the plug supplied with this equipment, you should contact your authorized dealer to obtain the correct lead.

# CONGRATULATIONS ON CHOOSING THIS COMPACT OVERLOCK MACHINE

Your machine is a high quality, easy-to-use product. To fully enjoy all the features, we suggest that you study this booklet.

If you need more information regarding the use of your machine, your nearest authorized dealer is always happy to be of service.

Enjoy yourself!

## ⚠ CAUTION

When threading or replacing needle, the main power and light switch of the machine must be switched off or the plug must be removed from the socket-outlet.

When the machine is not in use, it is recommended that the electric supply plug is disconnected from the wall socket to avoid any possible hazards.

## Notes on the motor

- The maximum operating speed of this sewing machine is 1,300 stitches per minute, which is quite fast compared to the normal operating speed of 300 to 800 stitches per minute for the ordinary sewing machine.
- The bearings in the motor are made of a special sintered, oil-impregnated alloy mounted in oilsoaked felt to withstand long hours of continuous operation.
- Continuous operation of the sewing machine can cause heat to build in the motor area, but not enough to adversely affect its performance.  
It is important to keep fabric and paper away from the air openings on the back and sides of the machine so air can get to these openings.
- When the motor is running, sparks can be seen through the air openings in the motor bracket on the side opposite the hand wheel. These sparks are produced by the carbon brushes and the commutator, and are part of the machines normal operation.

## WARNING LABELS (for complying with UL and CSA requirements)

The following warning labels are on the machine.

Be sure to observe the precautions described in the labels.

Caution (U.S.A. and CANADA only)

① **CAUTION:**  
MOVING PARTS- TO AVOID INJURY:  
CLOSE COVER BEFORE SEWING.  
UNPLUG BEFORE SERVICING.

② **AVERTISSEMENT:**  
PARTIES EN MOUVEMENT. POUR  
ÉVITER TOUTE BLESSURE:  
FERMER LE CAPOT AVANT DE  
COUDRE.  
DÉBRANCHER AVANT ENTRETIEN.

Label locations

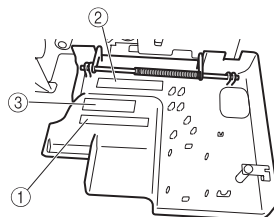

[Product code: 884-B02]

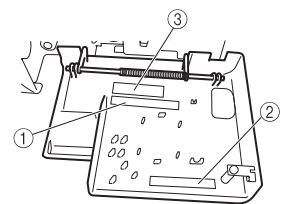

[Product code: 884-B03]

Face plate sticker (U.S.A. and CANADA only)

③ CLOSE DOOR BEFORE  
OPERATING MACHINE  
FERMER LE COUVERT AVANT  
D'OPÉRER LA MACHINE

# Contents

<b>Chapter 1: Names of parts and their functions</b> .....	<b>4</b>
Accessories .....	5
Powering the machine .....	6
Turning direction of hand wheel .....	6
Opening/ Closing front cover .....	6
Attaching/ Removing presser foot .....	6
Trim trap .....	7
Free-arm sewing (removing bed extension) .....	7
Retracting knife .....	8
Stitch length .....	8
Stitch width .....	8
Differential feed .....	9
Adjusting the presser foot pressure .....	9
Tension adjustment dial .....	10
Chart of thread tension adjustment, Two needle (Four thread) .....	11
Chart of thread tension adjustment, One needle (Three thread) .....	12
Needle .....	13
Removing/ Installing the needle .....	13
<b>Chapter 2 : Preparation before threading</b> .....	<b>14</b>
Thread tree .....	14
How to use the thread spool cap .....	14
How to use the thread net .....	14
Before threading .....	14
<b>Chapter 3: Threading</b> .....	<b>15</b>
Threading the lower looper .....	15
Threading the upper looper .....	17
Threading the right needle .....	18
Threading the left needle .....	18
<b>Chapter 4: Sewing materials, threads and needles comparison chart</b> .....	<b>19</b>
<b>Chapter 5: Sewing</b> .....	<b>20</b>
Stitch selection .....	20
Test sewing .....	20
Chaining-off .....	21
To start sewing .....	21
To remove work .....	21
To secure chain .....	22
If threads break during sewing .....	23
To sew fine materials .....	23
Narrow overlock/ Rolled hemming stitch .....	23
Chart of narrow overlock/ rolled hemming stitch .....	25
<b>Chapter 6: Troubleshooting</b> .....	<b>26</b>
<b>Chapter 7: Maintenance</b> .....	<b>27</b>
Cleaning .....	27
Oiling .....	27
<b>Chapter 8: Introduction of optional feet</b> .....	<b>28</b>
Blind stitch foot .....	28
Taping foot .....	30
Pearl sequence foot .....	31
Piping foot .....	32
Gathering foot .....	33
<b>Specifications</b> .....	<b>34</b>
<b>Setting record</b> .....	<b>35</b>

# CHAPTER 1 NAMES OF PARTS AND THEIR FUNCTIONS

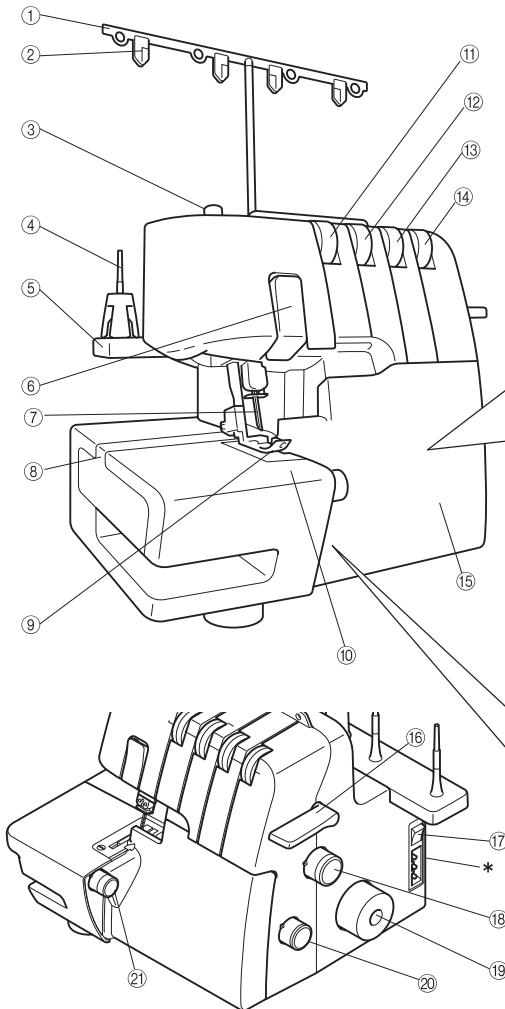

## Inside of the front cover

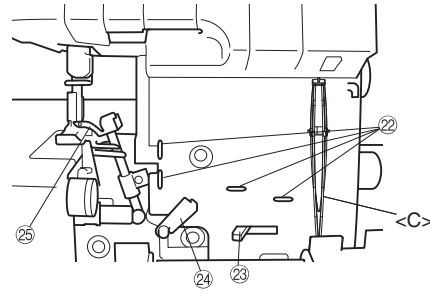

[Product code: 884-B02]

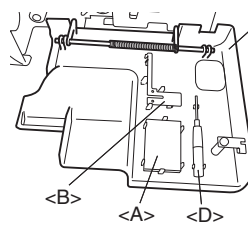

[Product code: 884-B03]

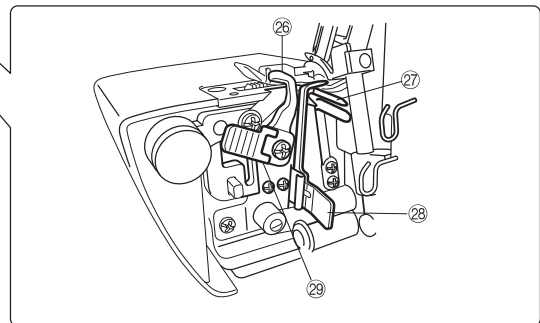
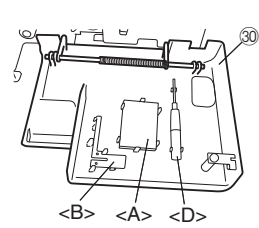

\* The product code is shown on the machine rating plate.

- ① Thread tree
- ② Thread plate
- ③ Presser foot pressure adjustment screw
- ④ Spool pin
- ⑤ Spool support
- ⑥ Thread take-up cover
- ⑦ Needles
- ⑧ Bed extension
- ⑨ Presser foot
- ⑩ Material plate cover
- ⑪ Left needle thread tension dial
- ⑫ Right needle thread tension dial
- ⑬ Upper looper thread tension dial
- ⑭ Lower looper thread tension dial
- ⑮ Front cover
- ⑯ Presser foot lifting lever
- ⑰ Main power and light switch
- ⑱ Stitch length adjustment dial

- ⑲ Hand wheel
- ⑳ Differential feed ratio adjustment dial
- ㉑ Stitch width dial

## Inside of the front cover

- ㉒ Thread guide
- ㉓ Lower looper threading lever
- ㉔ Thread take up for loopers
- ㉕ Upper looper
- ㉖ Upper knife
- ㉗ Lower looper
- ㉘ Stitch finger
- ㉙ Knife lever
- ㉚ Front cover compartment

You can hold the included accessories and the removed stitch finger in this front cover compartment.  
 <A>: Needle set, <B>: Stitch finger (when removed, see CHAPTER 5 "Narrow overlock/ Rolled hemming stitch"), <C>: Tweezers, <D>: Hexagonal driver

## Accessories

### Included accessory

- ① Soft cover: X77871000
- ② Accessory bag: XB2297001
- ③ Tweezers: XB1618001
- ④ Thread net (4): X75904000
- ⑤ Thread spool cap (4): X77260000
- ⑥ Cleaning brush: X75906001
- ⑦ Hexagonal driver: XB0393001
- ⑧ Needle set (130/705H): XB2772001  
#80: 2 pcs., #90: 2 pcs.
- ⑨ Foot controller:  
XC7359021 (120V Area)  
XB3112001 (230V Area)  
XB3134001 (U.K.)  
XB3200001 (Argentina)  
XB3156001 (Korea)  
XB3255001 (China)  
XB3190001 (Australia, New Zealand)  
XF2826001 (Brazil 127V)  
XB3178001 (Brazil 220V)
- ⑩ Instruction DVD: XB2791001 (NTSC)  
XB2776001 (PAL)

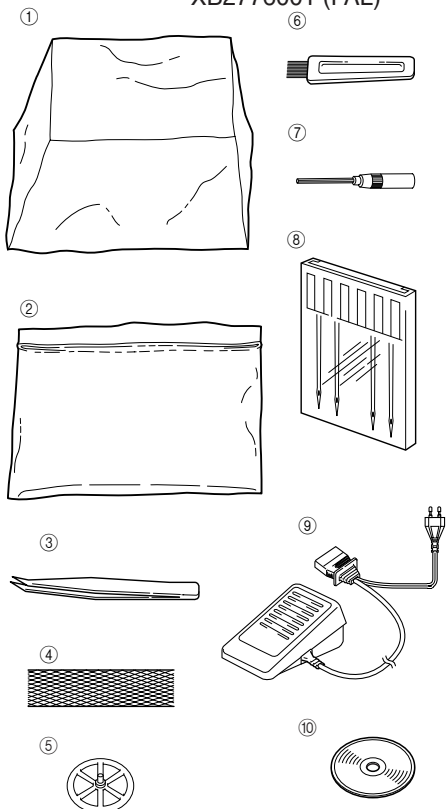

### Optional accessory

For further information about the following items, see CHAPTER 8.

- ⑪ Blind stitch foot: X76590002

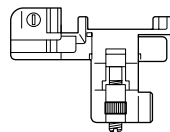

- ⑫ Gathering foot:  
SA213 (U.S.A., CANADA)  
X77459001 (OTHERS)



- ⑬ Pearl sequence foot:  
SA211 (U.S.A., CANADA)  
X76670002 (OTHERS)

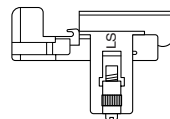

- ⑭ Piping foot:  
SA210 (U.S.A., CANADA)  
XB0241101 (OTHERS)

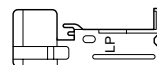

- ⑮ Taping (Elastic) foot:  
SA212 (U.S.A., CANADA)  
X76663001 (OTHERS)

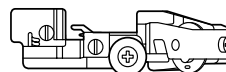

- ⑯ Trim trap: XB1530 for product code 884-B02



Trim trap: XB2793 for product code 884-B03

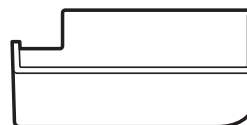

\* The part code differs depending on the color of the trim trap. Contact your authorized Brother dealer.

\* The product code is shown on the machine rating plate.

## Powering the machine

### Turning on the machine

1. Insert the three-pin plug into the socket on the bottom right side of the machine. Insert the power supply plug into a power outlet.
2. Turn the main power and light switch <A> to "I" mark (to "O" mark to turn off).

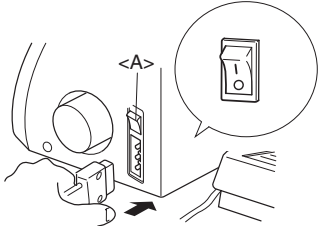

### Operation

When the foot controller is pressed lightly, the machine runs at a low speed. As the foot controller is pressed further, the machine will increase speed. When the foot controller is released, the machine stops.

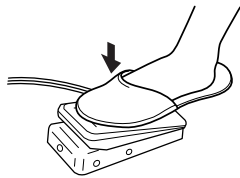

**NOTE (For U.S.A. only):**

Foot controller: Model KD-1902

This foot controller can be used on the machine with product code 884-B02 and 884-B03.

\* The product code is shown on the machine rating plate.

## Turning direction of hand wheel

The hand wheel <A> turns in a counterclockwise direction (direction of arrow). This is the same direction as an ordinary home sewing machine. The needles move to their highest positions by turning the hand wheel so that the mark <B> on the hand wheel is aligned to the line on the machine.

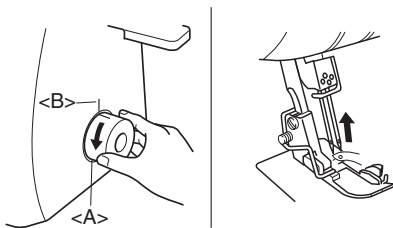

## Opening/ Closing front cover

It is necessary to open the front cover when threading this machine. Slide it to the right ① and open ②, or close it and slide it to the left.

### CAUTION

For your safety, make sure that the front cover is closed when operating the machine.

Always turn off the machine before opening the front cover.

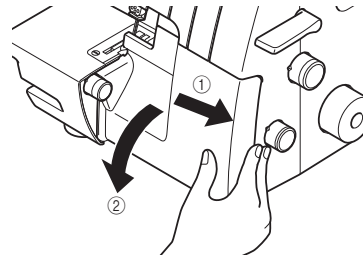

## Attaching/ Removing presser foot

1. Turn off the main power and light switch or disconnect the electric supply plug.
2. Raise the presser foot lever. ①
3. Turn the hand wheel ② so that the mark on the hand wheel is aligned to the line on the machine. (See CHAPTER1 "Turning direction of hand wheel".)
4. Push the button on the presser foot holder and the standard presser foot will be released. ③ ④
5. Raise the presser foot farther by pushing the presser foot lever upward. Then remove the presser foot and store it in a safe location.
6. Again, raise the presser foot farther by pushing the presser foot lever upward. Then place the presser foot just under the presser foot holder <A> so that the groove in the bottom of the presser foot holder <B> is aligned and catches the bar on the top of the foot <C>. Then lower the presser foot lever to attach the foot, pushing the button on the presser foot.

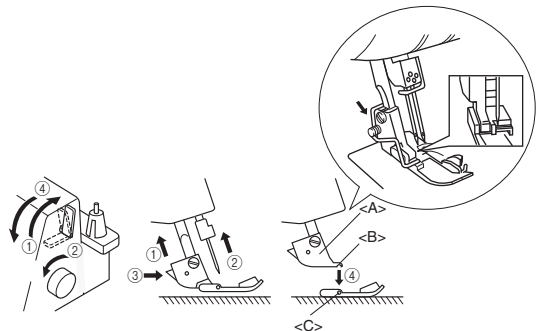



## Trim trap

The optional trim trap <A> holds the trimmed fabric and thread produced when sewing.

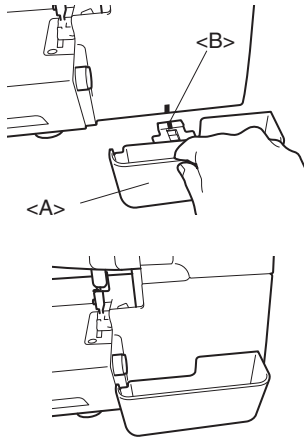

To install:  
Insert the trim trap <A> until it contacts the front cover.

**NOTE:**  
*Be sure to position the positioning guide <B> to the one on the machine.*

To remove:  
Slowly pull out the trim trap.

**NOTE:**  
*The optional trim trap can also be used as the foot controller holder.*

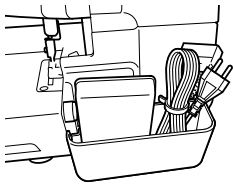

## ! CAUTION

Always remove the foot controller from the trim trap when carrying the machine.

## Free-arm sewing (removing bed extension)

Free-arm sewing enables tubular pieces to be sewn more easily.

1. Remove the bed extension <A>.

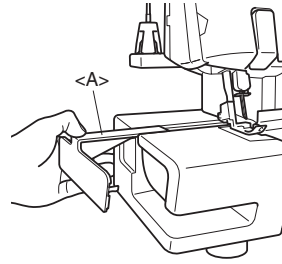

**NOTE:**  
*Be careful not to lose the removed bed extension.*

2. Position the fabric, and start sewing. (See CHAPTER 5.)

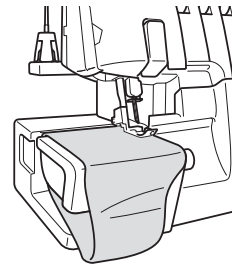

## Retracting knife

To sew without cutting the fabric edge, you need to retract the knife as follows.

### **CAUTION**

Do not touch the knife.

Move the knife lever only while the needle is at its lowest point.

Be sure to unplug the power supply cord from the wall outlet before retracting the knife.

1. Pull up the knife lever <A>, then pull it to the right.

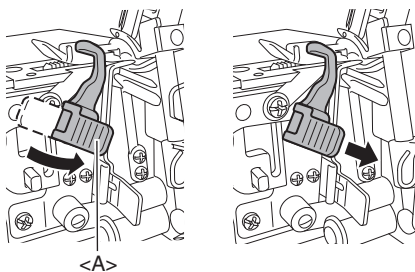

2. Bring down the knife.

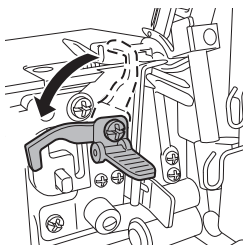

3. Retract the knife completely, then take your hand off from the lever.

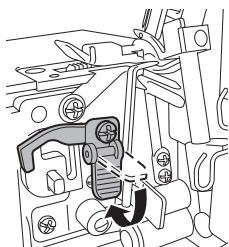

## Stitch length

The normal stitch length setting is 3 mm. To change the stitch length, turn the stitch length adjustment dial on the right side of the body.

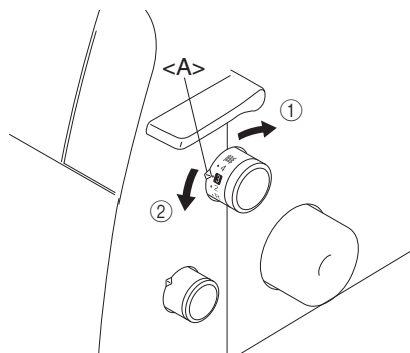

- ① Shorten the stitch length to a minimum of 2 mm (5/64 inch).
- ② Lengthen the stitch to a maximum of 4 mm (5/32 inch).

<A> Selection mark

## Stitch width

The normal stitch width setting for regular overlock stitch is 5mm (13/64 inch). To change the stitch width, turn the stitch width adjustment dial.

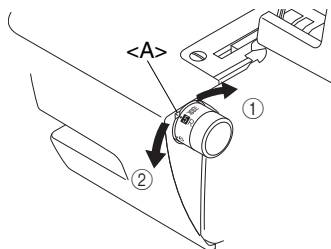







- ① Increase the width to a maximum of 7 mm (9/32 inch).
- ② Reduce the stitch width to a minimum of 5 mm (3/16 inch).

<A> Selection mark

## Differential feed

This serger is equipped with two sets of feed dogs under the presser foot to move the fabric through the machine. The differential feed controls the movement of both the front and the rear feed dogs. When set at 1, the feed dogs are moving at the same speed (ratio of 1). When the differential feed ratio is set at less than 1, the front feed dogs move slower than the rear feed dogs, stretching the fabric as it is sewn. This is effective on lightweight fabric that may pucker. When the differential feed ratio is set at greater than 1, the front feed dogs move faster than the rear feed dogs, gathering the fabric as it is sewn. This function assists in removing the rippling when serging stretch fabrics.

### Differential feed adjustment

Feed ratio	Main feed (rear)	Differential feed (front)	Effect	Application
0.7 - 1.0			Material is pulled tight.	Prevents thin materials from puckering
1.0			Without differential feed.	Normal sewing
1.0 - 2.0			Material is gathered or pushed together.	Prevents stretch materials from stretching or puckering

The normal setting is 1.0 on the differential feed adjustment dial.

To adjust the differential feed, turn the dial on the right bottom of the body.

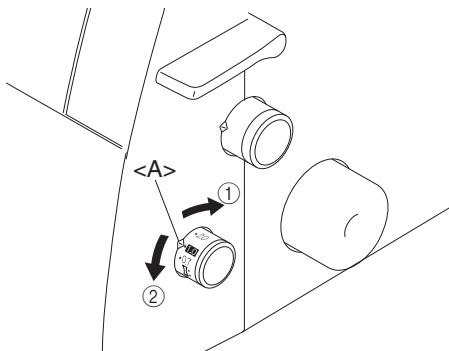

① Less than 1.0 ② Greater than 1.0 <A> Selection mark

### An example

When stretch material is sewn without using the differential feed, the edge will be wavy.

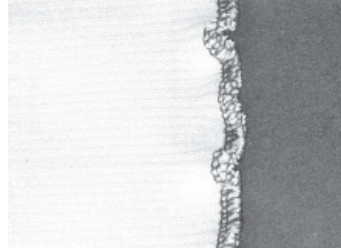

To get smooth finish, adjust the feed ratio from 1.0 toward 2.0.

(The feed ratio required depends on the elasticity of the material.)

The more elastic the material, the further toward 2.0 the differential feed ratio should be set. Test sew with a scrap of the fabric to find the correct adjustment.

## CAUTION

When sewing thick non-stretchable material such as denim, do not use the differential feed as it may damage the fabric.

### Adjusting the presser foot pressure

Turn the pressure adjustment screw on the top left of the machine. You can adjust by referring the value on the screw.

The normal setting is "2".

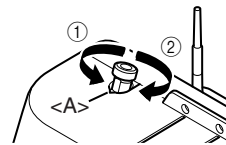

① Less pressure  
② More pressure  
<A> Selection mark

## Tension adjustment dial

There is a thread tension dial for each needle thread, the lower looper thread and the upper looper thread. The correct thread tension may vary according to the type and thickness of the fabric and the type of thread used. Thread tension adjustments may be necessary for any change in sewing materials.

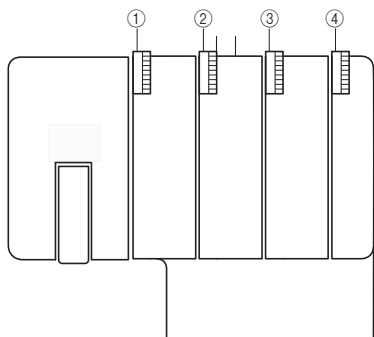

- ① Yellow marked tension disc is for left needle.
- ② Pink marked tension disc is for right needle.
- ③ Green marked tension disc is for upper looper.
- ④ Blue marked tension disc is for lower looper.

### Tension control

Sewing is possible at position "4" for most circumstances. (Standard: SPAN 60/3Z)

If the stitch quality is insufficient, select a different tension setting.

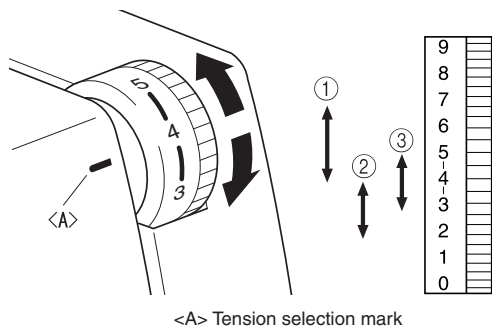

- ① For heavy tension: 4 to 7
- ② For light tension: 4 to 2
- ③ For medium tension: 5 to 3

If you cannot find the correct tension, refer to the charts on following pages.

## ⚠ CAUTION

Make sure that the thread is properly seated in the tension discs.

# Chart of thread tension adjustment, Two needle (Four thread)

- A: Reverse
- B: Surface
- C: Left needle thread
- D: Right needle thread
- E: Upper looper thread
- F: Lower looper thread

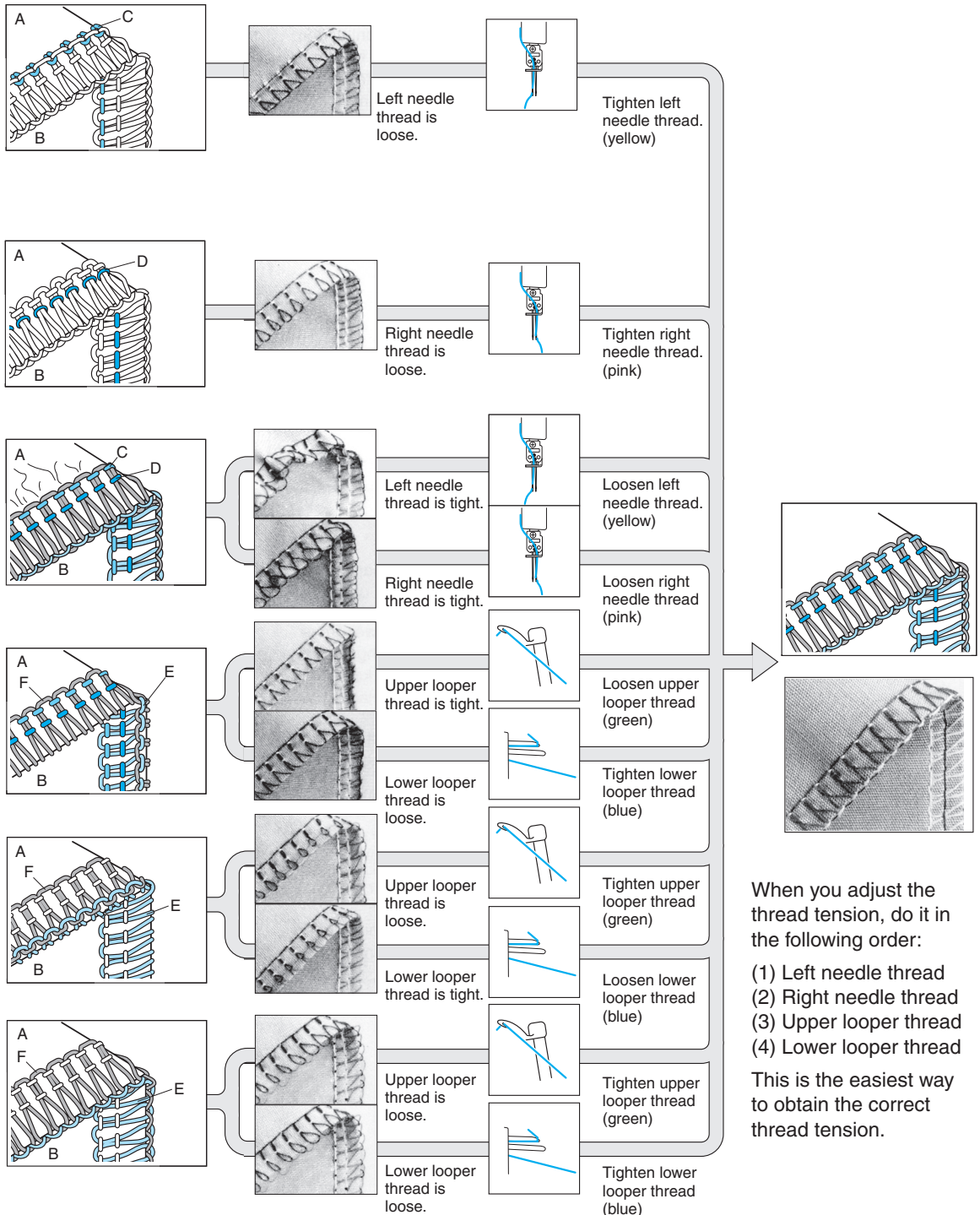

When you adjust the thread tension, do it in the following order:

- (1) Left needle thread
- (2) Right needle thread
- (3) Upper looper thread
- (4) Lower looper thread

This is the easiest way to obtain the correct thread tension.

# Chart of thread tension adjustment, One needle (Three thread)

- A: Reverse
- B: Surface
- C: Needle thread
- D: Upper looper thread
- E: Lower looper thread

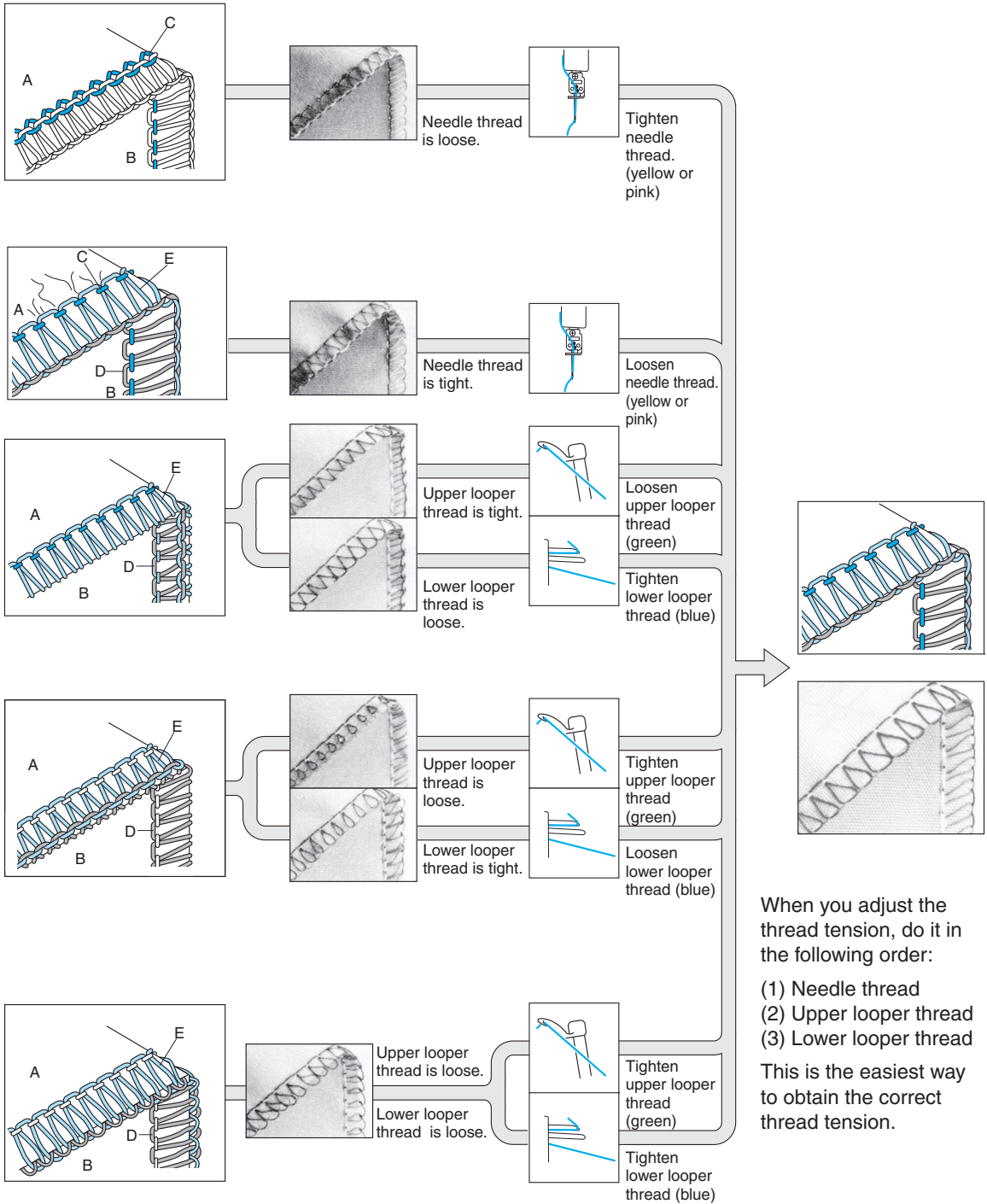

## Needle

This machine uses a standard home sewing machine needle.

The recommended needle is 130/705H (#80 or #90).

### Needle description

- ① Back (flat side) ② Front ③ Groove

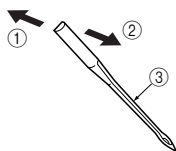

### How to check the needle

- ④ Flat surface  
⑤ Place the needle on its flat side and check to see if the space is parallel.

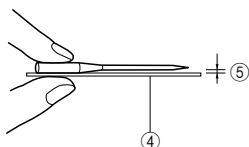

#### NOTE:

Countermeasures for material breakage <A>.

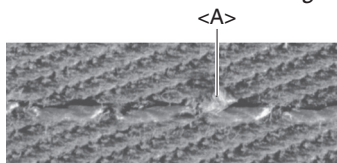

It can reduce the occurrence of material breakage by using 130/705H SUK (#90) BALL POINT.

## Removing/ Installing the needle

<A> Removing/ installing the left needle

<B> Removing/ installing the right needle

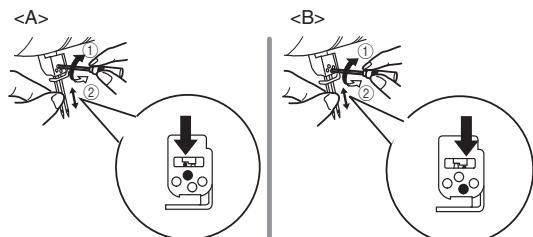

- ① Tighten ② Loosen

### To remove:

1. Turn the main power and light switch to the OFF position.
2. Turn the hand wheel so that the mark on the hand wheel is aligned to the line on the machine. (See CHAPTER 1 "Turning direction of hand wheel".)
3. Loosen the corresponding needle set screw with turning the included hexagonal driver toward ② in the figure, and remove the needle.

### To install:

1. Turn the main power and light switch to the OFF position.
2. Turn the hand wheel so that the line on the hand wheel is aligned to the line on the machine.
3. Hold the needle with its flat side away from you and insert it up as far as it will go.
4. Tighten the needle set screw securely with turning the included hexagonal driver toward ① in the figure.

#### NOTE:

Make sure to insert the needles all the way.

If the needles have been inserted correctly, the right needle should be set slightly lower than the left one.

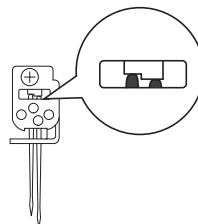

## CAUTION

Always be sure to turn off the power before removing/ inserting the needle.

Do not drop the needle and needle set screw in the machine, otherwise it may be damaged.

# CHAPTER 2 PREPARATION BEFORE THREADING

## Thread tree

Raise the telescoping thread tree to its highest position. Make sure that the thread holders are in alignment above the spool pins as illustrated below.

- ① Thread holder on thread tree
- ② Spool pin
- ③ Correct position

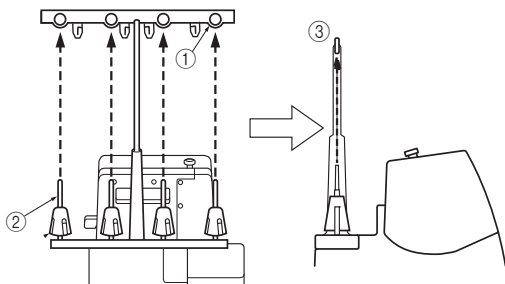

## How to use the thread spool cap

When using sewing thread spools, the thread spool cap should be used as illustrated below. Make sure that the spool notch is on the bottom.

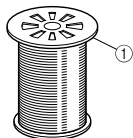

① Thread spool cap

## How to use the thread net

If you are sewing with loosely spun nylon thread, we recommend that you cover the spool with the net supplied to prevent the thread from slipping off the spool.

Adapt the net to the shape of the spool.



## Before threading

1. Turn off the main power and light switch for safety.

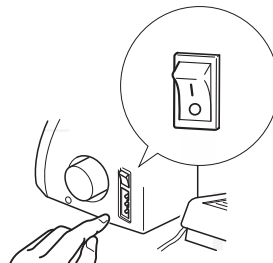

2. Raise the presser foot using presser foot lever.

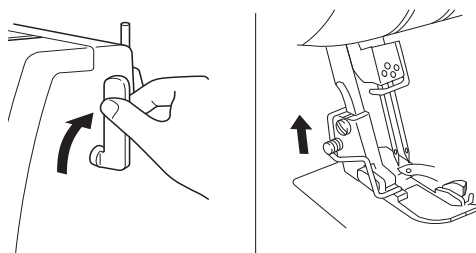

3. Turn the hand wheel so that the mark on the hand wheel <A> is aligned to the line <B> on the machine. (See CHAPTER 1 "Turning direction of hand wheel".)

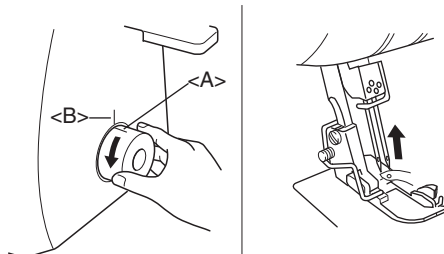



# CHAPTER 3 THREADING

## ⚠ CAUTION

Turn off the machine before threading for safety.

Threading has to be done in the following order.

1. Lower looper
2. Upper looper
3. Right needle
4. Left needle

### Threading the lower looper

Run the thread in the sequence illustrated, following the blue color and the numbers next to each threading point.

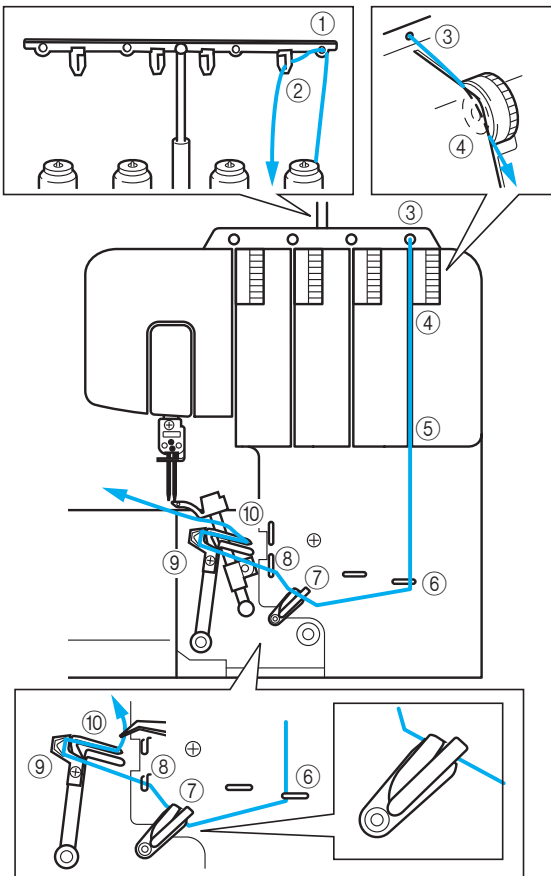

1. Open the front cover by sliding to the right and guiding the top toward you.
2. Pull the thread off the spool and directly up through the thread holder ① and the thread plate ② on the thread tree from back to front.
3. Pass the thread through the hole ③ on the top of machine.

4. Pass the thread through the tension disc ④ which is in the channel next to the blue tension adjustment dial.
5. Guide the thread down the channel and pass the thread through the threading points ⑤⑥⑦⑧ next to the blue color marks following the numerical order in the accompanying illustration.

**NOTE:**

*Make sure to thread both of the thread take ups ⑦.*

Continue on "Lower looper easy threading operation".

### Lower looper easy threading operation

1. Slide the lower looper threading lever <A> to the right.

The lower looper <B> moves to the position illustrated as below.

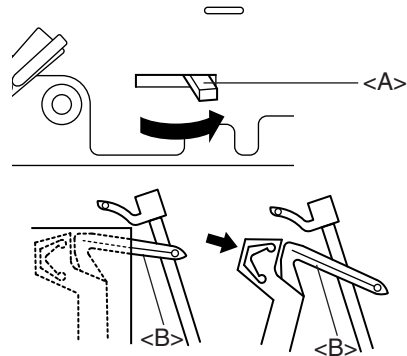

## ⚠ CAUTION

Slide the threading lever only in the directions shown by the arrow. Forcefully moving the threading lever in any other direction may damage it.

Before sliding the lower looper threading lever, make sure the needle is at its highest position.

2. Pass the thread as illustrated.

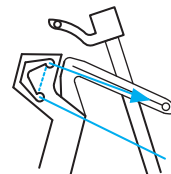

3. Pass the thread through the eye of the lower looper.

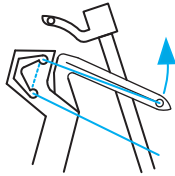

4. Slowly turn the hand wheel, and make sure the returns to the original position.

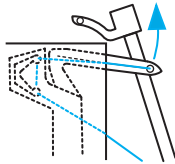

**NOTE:**

*If the lower looper thread breaks during sewing, cut and remove thread from both of the needles.*

*Before re-threading the lower looper, make sure that the lower looper re-threading is done exactly as diagrammed. The machine will not operate properly if the threading is not done in the proper sequence.*

## **⚠ CAUTION**

---

Thread the needles after the lower looper and upper looper have been threaded.

---

## Threading the upper looper

Run the thread in the sequence illustrated, following the green color and the numbers next to each threading point.

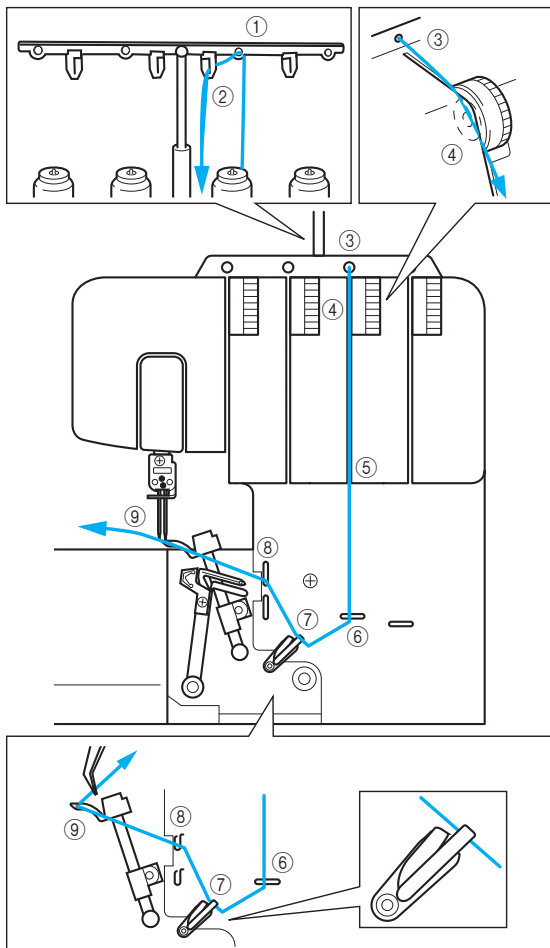

1. Open the front cover by sliding to the right and guiding the top toward you.
2. Pull the thread off the spool and directly up through the thread holder ① and the thread plate ② on the thread tree from back to front.
3. Pass the thread through the hole ③ on the top of machine.
4. Pass the thread through the tension disc ④ which is in the channel next to the green tension adjustment dial.

5. Guide the thread down the channel and pass the thread through the threading points ⑤⑥⑦⑧ next to the green color marks following the numerical order in the accompanying illustration.

**NOTE:**

*Make sure to thread only through the upper thread take up ⑦.*

6. Pass the thread through the eye of the upper looper ⑨.

**NOTE:**

*If the upper looper thread breaks during sewing: This may be caused by the lower looper thread getting caught on the upper looper. If this happens, lower the upper looper by turning the hand wheel, remove the lower looper thread from the upper looper, and re-thread the upper looper from at least the tension disc.*

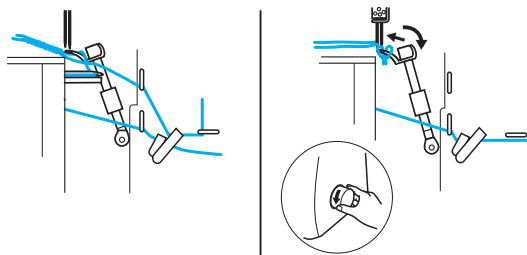

## Threading the right needle

Run the thread in the sequence illustrated below, following the pink color and the numbers next to each threading point.

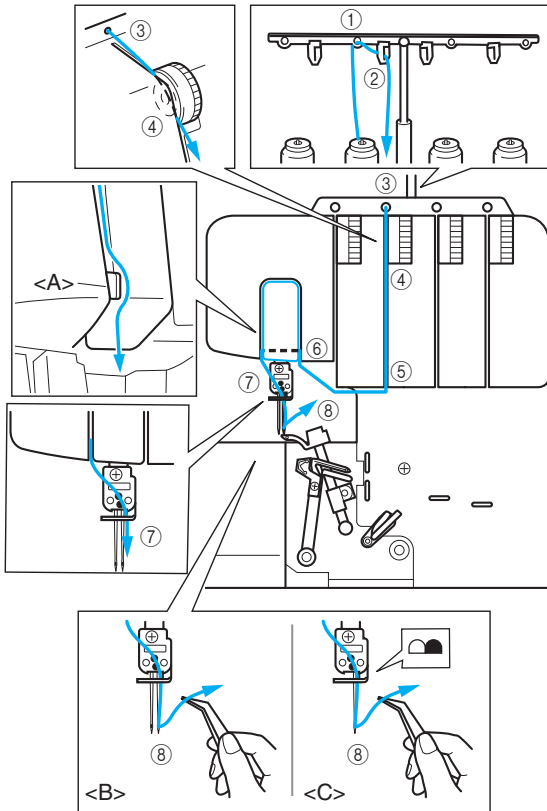

1. Pull the thread off the spool and directly up through the thread holder ① and the thread plate ② on the thread tree from back to front.
2. Pass the thread through the hole ③ on the top of machine.
3. Pass the thread through the tension disc ④ which is in the channel next to the pink tension adjustment dial.
4. Guide the thread down the channel and across through the threading points ⑤ ⑥ ⑦ next to the pink color marks following the numerical order in the accompanying illustration.

**NOTE:**

Make sure the thread is through the right of the separator <A>.

5. Bring the thread down through the needle bar thread guide and through the right needle ⑧ from front to back.  
(<B>: two needles/ <C>: one needle)

## Threading the left needle

Run the thread in the sequence illustrated, following the yellow color and the numbers next to each threading point.

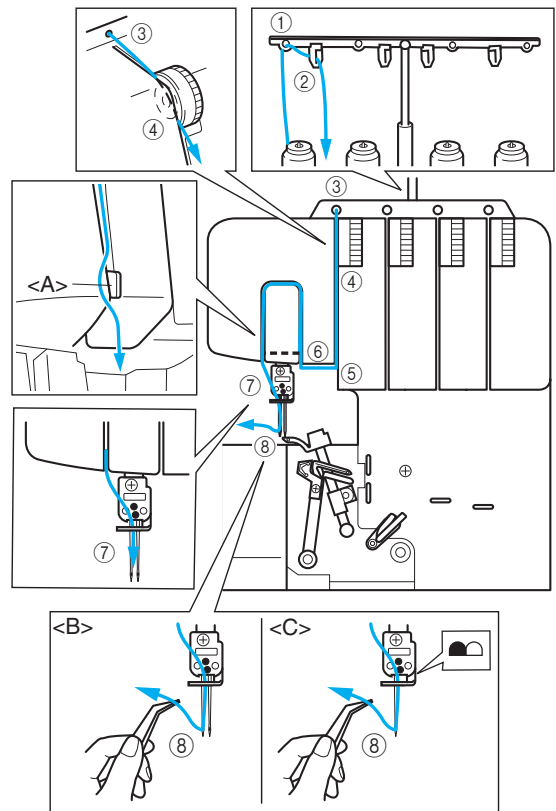

1. Pull the thread off the spool and directly up through the thread holder ① and the thread plate ② on the thread tree from back to front.
2. Pass the thread through the hole ③ on the top of machine.
3. Pass the thread through the tension disc ④ which is in the channel next to the yellow tension adjustment dial.
4. Guide the thread down the channel and across through the threading points ⑤ ⑥ ⑦ next to the yellow color marks following the numerical order in the accompanying illustration.

**NOTE:**

Make sure the thread is through the left of the separator <A>.

5. Bring the thread down through the needle bar thread guide and through the left needle ⑧ from front to back.  
(<B>: two needles/ <C>: one needle)

# CHAPTER 4

## SEWING MATERIALS, THREADS AND NEEDLES COMPARISON CHART

Material	Stitch	Stitch Length (mm)	Thread	Needle
Fine materials: Georgette Lawn Organdy Tricot	Overlock stitch	2.0-3.0	Spun #80-90 Cotton #100 Tetron #80-100	130/705H #80
Fine materials: Georgette Lawn Organdy Tricot	Narrow over lock/ Rolled hemming stitch	R-2.0	Needle thread : Spun #80-90 Tetron #80-100  Looper thread : Woolly nylon thread Spun #80-90 Tetron #80-100	130/705H #80
Medium materials: Broad cloth Gabardine Serge	Overlock stitch	2.5-3.5	Spun #60-80 Cotton #60-80 Tetron #60-80	130/705H #80 #90
Medium materials: Broad cloth	Narrow over lock/ Rolled hemming stitch	R-2.0	Needle thread : Spun #60-80 Tetron #60-80  Looper thread : Woolly nylon thread Spun #60-80 Tetron #60-80	130/705H #80 #90
Heavy materials: Tweed Denim Knits	Overlock stitch	3.0-4.0	Cotton #50-60 Spun #60 Tetron #50-60	130/705H #90

**NOTE:**

*Decorative thread will work best in the upper looper for fashion sewing.*

# CHAPTER 5 SEWING

## Stitch selection

Select the stitch pattern before you start sewing. This sewing machine can sew five different stitches by following the simple steps below:

### Four-thread overlock stitch

Use all four threads and two needles for producing four-thread overlock stitches.

Use: Produces strong seam. Ideal for sewing knits and wovens.

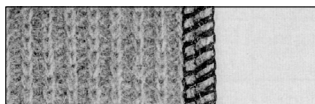

### Three-thread overlock stitch 5 mm (3/16 inch)

Use three threads and the left needle, producing 5 mm (3/16 inch) seams.

Use: For overlock stitching on suits, blouses, slacks, etc. Ideal for medium to heavy materials.

#### NOTE:

Remove the right needle when sewing this overlock stitch.

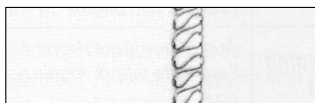

### Three-thread overlock stitch 2.8 mm (7/64 inch)

Use three threads and the right needle, producing 2.8 mm (7/64 inch) seams.

Use: For overlock stitching on suits, blouses, slacks, etc. Ideal for fine to medium materials.

#### NOTE:

Remove the left needle when sewing this overlock stitch.



### Narrow overlock stitch 2.0mm (5/64 inch) and

### Rolled hemming stitch 2.0mm (5/64 inch)

Use as decorative or finishing stitch. See "Narrow overlock/ Rolled hemming stitch" in this chapter for details.

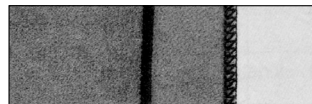

#### NOTE:

You can use the optional accessory foot for even more varieties of stitches. See CHAPTER 8 for details.

## Test sewing

Test-sew before you start sewing.

1. Set all the thread tension to "4".
2. Thread the machine and pull all threads out about 15 cm (6 inches) behind the presser foot.

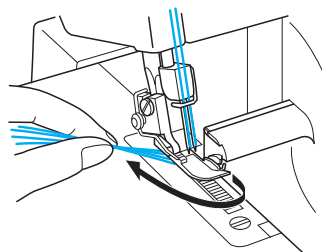

3. Place a piece of scrap material under the presser foot for test sewing.

#### NOTE:

Always lift the presser foot before placing the fabric under it. You cannot start sewing by just running the fabric under the foot without lifting the presser foot.

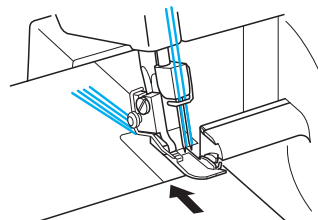

4. Holding all threads with your left hand, turn the hand wheel slowly a few times toward you, and check to see that the threads entwine themselves before using the foot controller to sew.

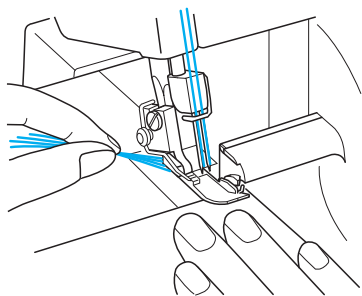

### Chaining-off

After test-sewing, continue to depress the foot controller slightly and chain off 10 cm (4 inches). The threads will entwine themselves into a chain automatically.

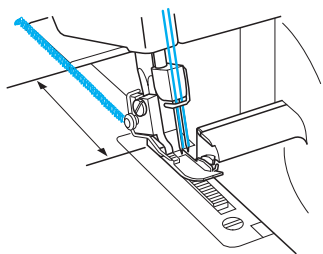

#### NOTE:

*If the thread tension is not correctly balanced, the chaining-off result will be uneven. If this happens, pull the threads slightly. Check the threading order and adjust the thread tension to create an even chain. (See CHAPTER 1 "Tension adjustment dial".)*

### To start sewing

1. Thread the machine and pull all threads out about 15 cm (6 inches) behind the presser foot.

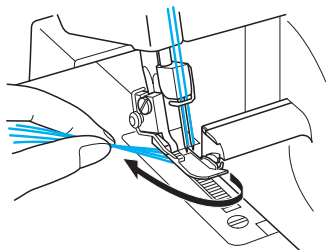

2. Lift the presser foot and place the material well underneath the presser foot before starting to sew. Slowly sew a few stitches by turning the hand wheel.

3. The fabric will be fed automatically. You need only guide it in the required direction.
4. Check the stitch formation (stitch chain) to see if it is uniform. If the stitch is not uniform, re-check that the threading has been done properly and in sequence.
5. Follow the Seam Allowance Guide for consistent cutting of the fabric seams. The scale of Seam Allowance Guide shows 9.5, 12.7, 15.9, and 25.4 mm (3/8, 1/2, 5/8, and 1 inches) when the stitch width dial is set to "5".

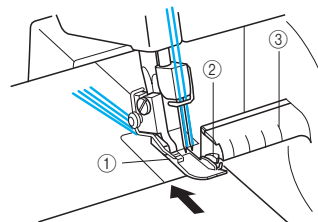

① Presser foot ② Upper knife ③ Seam Allowance Guide

### To remove work

When the seam is finished, keep the machine running at a low speed to obtain chaining-off. Then cut the stitches 5 cm (2 inches) from the work. If feeding for chaining-off is not enough, pull the thread gently.

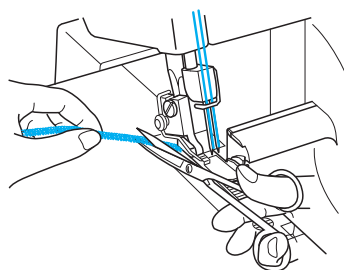

## To secure chain

There are two methods available to secure the chain.

### Method 1

Secure the chain of the beginning and the end of a stitch with your machine.

#### At the beginning of a stitch

1. Sew a few stitches, after chaining-off for 5 cm (2 inches).
2. Stop the machine and raise the presser foot.
3. Put the chain under the presser foot, and serge over it pulling toward you.
4. After sewing a few stitches, cut off the extra chain with the knife as illustrated.

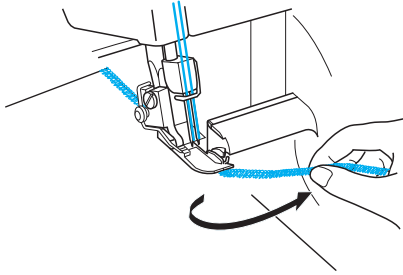

#### At the end of a stitch

1. At the end of the seam, sew one stitch out of the fabric before stopping the machine.

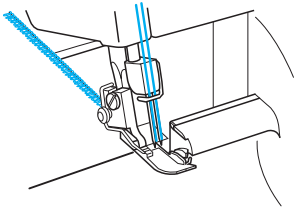

2. Raise the presser foot and the needles, then reverse the fabric.

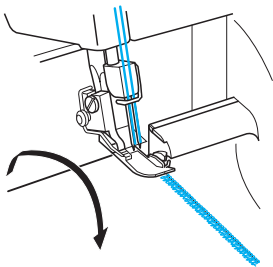

3. Lower the needles and the presser foot at the same position.
4. Serge over the seam, taking care not to cut the serged seam with a knife.
5. After sewing a few stitches, serge off the fabric as illustrated.

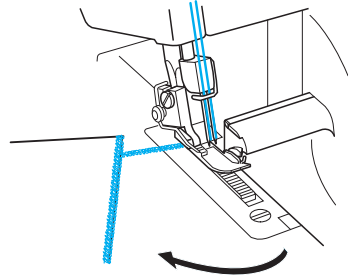

6. Cut the threads with scissors.

### Method 2

With this method, the chain of the beginning and the end of a stitch can be secured in the same manner.

1. Tie the thread unpicked from chain.

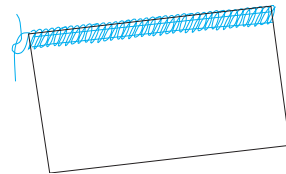

2. Insert the chain into the end of the seam, using a hand sewing needle with large eye.

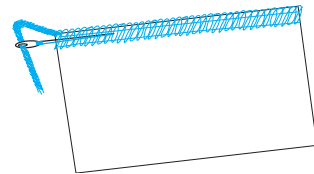

3. Fix the chain with a drop of fabric glue, and cut the extra stitches after drying.

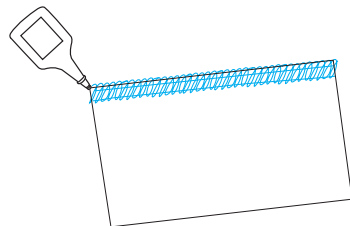



## If threads break during sewing

Remove the material and re-thread in the correct order, Lower looper, Upper looper, right needle and then the left needle (to re-thread, see CHAPTER 3 "Threading"). Replace the material under the presser foot and sew 3-5 cm (1-1/8 to 2 inches) over the previous stitches.

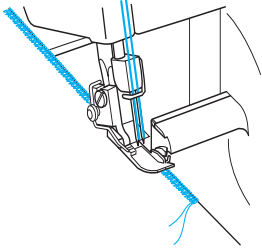

## ! CAUTION

Do not leave straight pins in the fabric when sewing as they will damage the needles and knives.

## To sew fine materials

1. Adjust the presser foot pressure to prevent the material from puckering and to allow sewing of curves. (See CHAPTER 1 "Adjusting the presser foot pressure".)
2. Loosen the thread tension, but remember that if the tension is too loose, the thread may break and stitches may be skipped.

## Narrow overlock/ Rolled hemming stitch

The Narrow overlock/Rolled hemming stitch is a decorative finish for lightweight to midweight fabrics. It is often used to complete the edge of a fabric. This stitch is sewn by removing the left needle and using the 3-thread overlock stitch.

### Instructions for both narrow overlock/ Rolled hemming stitches

## ! CAUTION

Turn off the main power and light switch before removing/ installing a needle.

1. Remove the left needle.

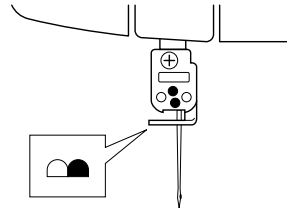

### NOTE:

For the recommended thread and needle, see CHAPTER 4 "Sewing materials, threads, and needles comparison chart".

2. Thread the machine for a three thread overlock, using the right needle.
3. Remove the stitch finger <A>.
  - ① Raise the presser foot lever.
  - ② Pull all threads toward the back of the machine.
  - ③ Check to make sure that the thread is no longer wrapped around the stitch finger.
  - ④ Open the front cover.
  - ⑤ Turn the hand wheel until the upperlooper is at its lowest position.
  - ⑥ Pull the stitch finger to the right and remove it.

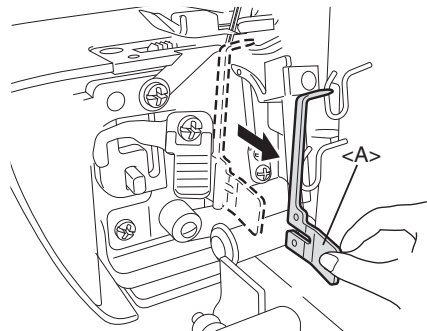

Storage for the stitch finger <A> is provided on the inside of the front cover.

[Product code: 884-B02]

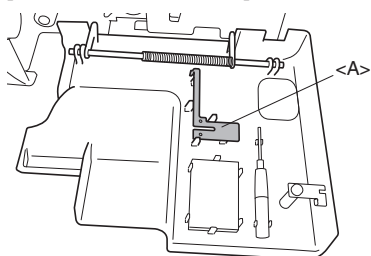

[Product code: 884-B03]

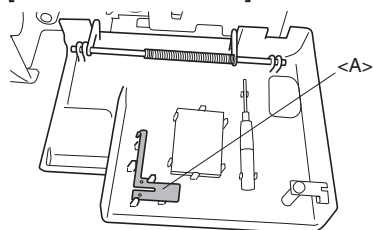

\* The product code is shown on the machine rating plate.

**NOTE:**

*Make sure to install stitch finger when sewing regular overlock stitches.*

4. Adjust the stitch width dial up to the "R" position.

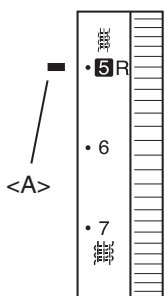

<A> Selection mark

5. Adjust the stitch length.  
Set the stitch length adjustment dial to "R to 2" position (for narrow overlock stitch: R to 2, for rolled hemming stitch: R).

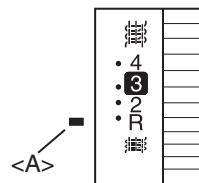

<A> Selection mark

## Chart of narrow overlock/ Rolled hemming stitch

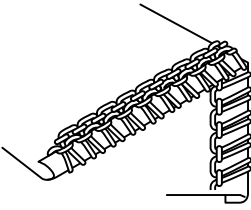
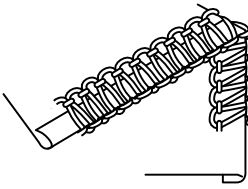
	Rolled hemming stitch	Narrow overlock stitch
Stitch Style	<p>Underside of material</p>  <p>Top of material</p>	<p>Underside of material</p>  <p>Top of material</p>
Materials	See CHAPTER 4 "Sewing materials, threads, and needles comparison chart".	See CHAPTER 4 "Sewing materials, threads, and needles comparison chart".
Needle thread	See CHAPTER 4 "Sewing materials, threads, and needles comparison chart".	See CHAPTER 4 "Sewing materials, threads, and needles comparison chart".
Upper looper thread	See CHAPTER 4 "Sewing materials, threads, and needles comparison chart".	See CHAPTER 4 "Sewing materials, threads, and needles comparison chart".
Lower looper thread	See CHAPTER 4 "Sewing materials, threads, and needles comparison chart".	See CHAPTER 4 "Sewing materials, threads, and needles comparison chart".
Stitch Length	R (R-2.0)	R (R-2.0)
Stitch Width	R (R-6)	R (R-6)
Stitch Finger	Removed	Removed
Thread Tension	For fine materials    For medium materials	For fine materials    For medium materials
Needle Thread	4 (3 - 5)                  5 (4 - 6)	4 (3 - 5)                  5 (4 - 6)
Upper looper Thread	5 (4 - 6)                  5 (4 - 6)	5 (4 - 6)                  6 (5 - 7)
Lower looper Thread	7 (6 - 8)                  7 (6 - 8)	5 (4 - 6)                  6 (5 - 7)

# CHAPTER 6

## TROUBLESHOOTING

This sewing machine is designed for trouble-free operation. However, the following chart indicates trouble which may occur if basic adjustments are not made properly.

Trouble	Cause	Remedy
1. Does not feed	Presser foot pressure too loose	Turn the pressure adjustment screw clockwise to increase the presser foot pressure. (See page 9.)
2. Needles break	1. Needles bent, or needle tip blunt	Replace with new needle. (See page 13.)
	2. Needles incorrectly installed	Install needles correctly. (See page 13.)
	3. Material pulled forcibly	Do not press or pull material too hard when sewing.
3. Threads break	1. Improper threading	Thread correctly. (See pages 15-18.)
	2. Thread tangled	Check spool pin, thread holders, etc. and remove tangled thread.
	3. Thread tension too tight	Adjust the thread tension. (See pages 10-12.)
	4. Needles incorrectly installed	Install needles correctly. (See page 13.)
	5. Wrong needle used	Use correct needle. 130/705H - suggested (See page 13.)
4. Skipped stitches	1. Needle bent, or needle tip blunt	Replace with new needle. (See page 13.)
	2. Needle incorrectly installed	Install needle correctly. (See page 13.)
	3. Wrong needle used	Use correct needle. 130/705H - suggested (See page 13.)
	4. Improper threading	Thread correctly. (See pages 15-18.)
	5. Presser foot pressure too loose	Turn the pressure adjustment screw clockwise to increase the presser foot pressure. (See page 9.)
5. Stitches are not uniform	Thread tensions are not adjusted properly	Adjust the thread tension. (See pages 10-12.)
6. Fabric is puckered	1. Thread tension too tight	Decrease thread tension when sewing lightweight or fine material. (See pages 10-12.)
	2. Improper threading or thread tangled	Thread correctly. (See pages 15-18.)

# CHAPTER 7 MAINTENANCE

## Cleaning

### ⚠ CAUTION

Turn off the machine before cleaning.

Turn the hand wheel and move the needles down.

Periodically clean dust, trimmed fabric and thread with the included cleaning brush.

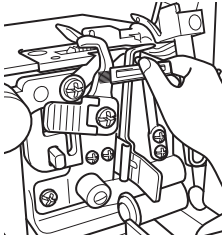

## Oiling

For smooth and silent operation, the moving parts (indicated with arrows) of the machine should be oiled periodically.

### ⚠ CAUTION

Turn off the machine before opening the front cover and oiling.

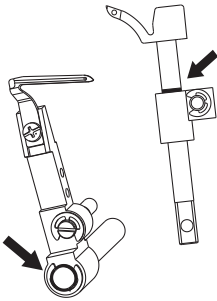

**NOTE:**

*Be sure to oil your sewing machine before use.  
Always clean the lint off your machine before you apply oil.*

*Oil the machine once or twice a month for normal use. If the machine is used more often, oil it once a week.*

# CHAPTER 8 INTRODUCTION OF OPTIONAL FEET

## ⚠ CAUTION

Turn off the machine while replacing the presser foot.

### Blind stitch foot

#### Features

When using the blind stitch presser foot (multi purpose foot), you can sew blind stitches and overlock at the same time. This is ideal when sewing cuffs, trouser bottoms, pockets, and hemming skirts etc.

The stitch guide on this foot is also useful when sewing special stitches like flatlock, pin tuck and other decorative stitches.

#### Blind stitching

The blind hem stitch is used for putting a near invisible hem in garments or home decoration projects. Use it to hem pants, skirts, or draperies.

#### Recommended settings

- Stitch Width: 5 mm
- Stitch Length: 3 - 4 mm
- Needle Thread Tension: Slightly Slackened (0-2)
- Upper Loper Thread Tension: Slightly Tightened (5-7)
- Lower Loper Thread Tension: Slightly Slackened (2-4)

#### Procedure

1. Attach the blind stitch foot (see CHAPTER 1 "Attaching/ Removing presser foot").
2. Set up the machine for 3 thread overlock stitch with one needle in the left position. The right needle should be removed.
3. Turn the wrong side of the fabric out, fold the fabric once and then back to the required width, as illustrated.

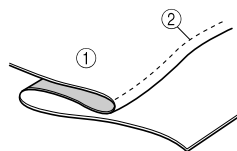

- ① Reverse
- ② Needle path

Sewing will be easier if a crease is ironed into the folded fabric before sewing.

4. Turn the hand wheel so that the line on the hand wheel is aligned to the line on the machine (see CHAPTER 1 "Turning direction of hand wheel").

5. Lift the presser foot lever and insert the fabric with the folded edge on the left in such a way that the needle pierces just the folded edge as it sews.
6. Lower the presser foot lever, adjust the fabric guide toward the folded edge.
7. Adjust the guide position of the presser foot with the adjusting screw so that the needle is lightly touching the crease in the fabric. In this case, the thickness of the fabric is the criterion. By turning the screw forward (toward you) the fabric guide will go to the right. By turning the screw backward (away from you) the fabric guide will go to the left.

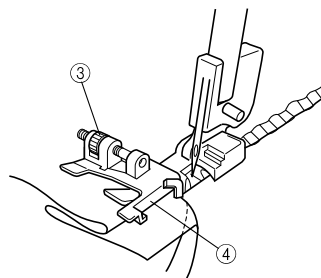

- ③ Adjusting screw
- ④ Fabric guide

To adjust the position of the fabric guide, a piece of the same fabric should be used to do a sewing test.

8. While folding the fabric by hand, sew so that the needle just catches the edge of the crease.
9. Open the fabric as shown in the illustration.

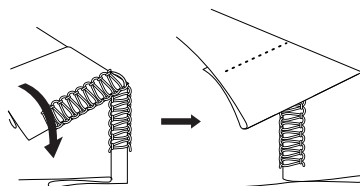

For best results, use a fine thread in a color that matches the fabric.

When done correctly, this stitch will be very hard to see on the right side of the fabric.

#### Flatlock stitching

The Flatlock stitch is primarily used as a decorative finish on a project. The finished stitch can look like a ladder or small parallel lines when the fabric is pulled flat.

#### Recommended settings

- Stitch Width: 5 mm
- Stitch Length: 2 - 4 mm
- Needle Thread Tension: 0-3
- Upper Loper Thread Tension: 2-5
- Lower Loper Thread Tension: 6-9

## Procedure

1. Attach the blind stitch foot (see CHAPTER 1 "Attaching/ Removing presser foot").
2. Set up the machine for 3 thread overlock with one needle in the left position. The right needle should be removed.
3. Fold the fabric as shown in the illustration.

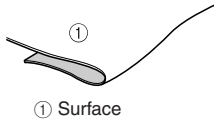

4. Turn the hand wheel so that the line on the hand wheel is aligned to the line on the machine (see CHAPTER 1 "Turning direction of hand wheel").
5. Lift the presser foot lever and insert the fabric with the folded edge in such a way that the needle pierces just on the fold.
6. Lower the presser foot lever, adjust the fabric guide toward the folded edge.
7. Adjust the guide position of the presser foot with the adjusting screw so that the needle moves down to a position 1/8 inch (2.5 to 3.0 mm) inside the folded edge of the fabric, so that some of the stitching loops over the edge.

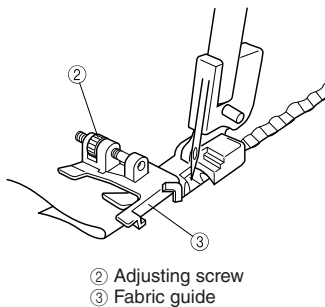

By turning the screw forward the fabric guide will go to the right. By turning the screw backward the fabric guide will go to the left. To adjust the position of the fabric guide, a piece of the same fabric can be used to do a sewing test.

8. While holding the fabric pieces together, sew at a constant speed down the fold.

9. When stitching is finished, pull the fabric open (flat).

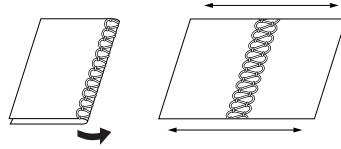

Either stitch finish can be used on the right side of the fabric. If you sew with the wrong sides together, the upper looper thread will decorate the right side when pulled flat. If you sew with the right sides together, the needle thread ladder will decorate the right side when pulled flat.

## NOTE:

*This method is not suitable for thin fabrics.*

## Pin tuck stitching

The Pin tuck stitch uses a rolled edge to add shape and decoration to any sewing project. Contrasting thread in the upper looper adds an accent to your project.

For thin fabrics, it's a good idea to choose a fine thread which will run smoothly.

## Procedure

1. Attach the blind stitch foot (see CHAPTER 1 "Attaching/ Removing presser foot").
2. Set up the machine for narrow overlock stitching. (Refer to CHAPTER 5 "Narrow overlock/ Rolled hemming stitch".)
3. Draw equally spaced lines on the fabric with a fabric pencil as guides for pin tuck placement. Fold the fabric along one of the lines and press in place lightly with an iron.

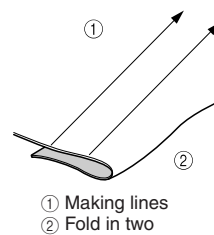

4. Turn the hand wheel so that the line on the hand wheel is aligned to the line on the machine (see CHAPTER 1 "Turning direction of hand wheel").
5. Lift the presser foot lever and insert the fabric with the folded edge in such a way that the needle pierces just the folded edge.
6. Lower the presser foot lever, adjust the fabric guide toward the folded edge.

7. Align the blind stitch presser foot guide with the line on the right side of the stitch finger. By turning the screw forward the stitch guide will go to the right. By turning the screw backward the stitch guide will go to the left.
8. Align the fold with the guide and insert the fabric up to the needle position.

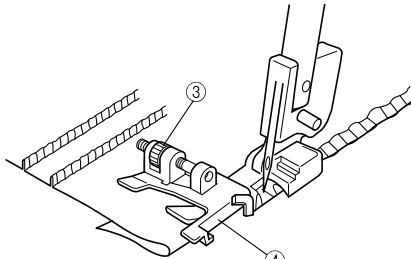

③ Adjusting screw  
④ Fabric guide

9. Guide the fold in the fabric to sew half way between the needle and the upper knife.
10. Continue sewing until all marked lines have been sewn.

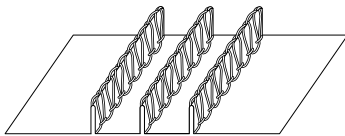

Correct minor contractions by hand.

## Taping foot

### Features

By using the tape presser foot, you can sew tapes, as well as elastics and hem at the same time beautifully.

- Tapes or elastics from 6mm up to 12mm width can be sewn.
- Attatching tapes is very useful for reinforcement on stretchable materials such as knitted garment at shoulder. Also attaching elastics is suitable for sewing cuffs, neckline and so on.

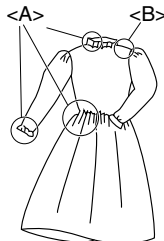

<A> Usage of the elastic  
<B> Usage of the tape

### Machine setting (type of stitch):

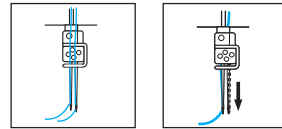

- 2 needle 4 thread overlock
- 1 needle 3 thread overlock (Either needle can be used.)

### How to set the elastic / tape

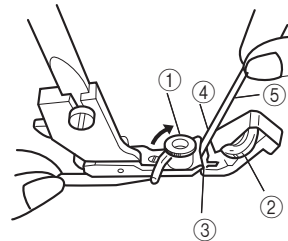

1. Attach the taping foot (see CHAPTER 1 "Attaching/ Removing presser foot").
2. Lift the presser foot lever.
3. Turn the hand wheel so that the line on the hand wheel is aligned to the line on the machine (see CHAPTER 1 "Turning direction of hand wheel").
4. Flip open the tape guide ①, then set the presser adjusting dial ② at "0".
5. Put the tape or the elastic ⑤ through the slot ③.
6. Insert the tape or the elastic ⑤ through the slot ③ so that the righthand side of tapes / elastics will be set along the guide ④.
7. Flip shut the tape guide ① so that it will be set at the lefthand side of tapes / elastics.

### Test sewing

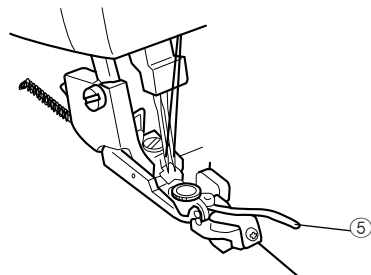

1. Lift the presser foot lever.
2. Insert the materials, till the edge of the materials will touch the blade.
3. Lower the presser foot lever.
4. Set the stitch width control dial at "5".



- Set the stitch length control lever.
  - Tapes: between "3" and "4"
  - Elastics: "4"
- Adjust the presser adjusting dial ②
  - at "0" when sewing with tapes.
  - at desirable number for contraction when sewing with elastics.

**NOTE:**

Contraction will be increased with larger number.

- Make trial sewing and adjust thread tensions.  
Example of proper sewing seam:

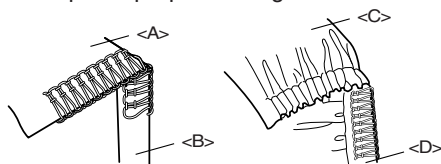

- <A> Surface
- <B> Tape
- <C> Surface
- <D> Elastic

**NOTE:**

Thread tensions are alike to normal over edging when sewing with tapes.  
It is recommendable to have a stronger tension for under looper and over looper for beautiful finish.  
It is advisable to make trial sewing on each material / thread due to different contraction.

## Pearl sequence foot

### Features

By using the pearl sequence foot, you can bead on fabric. It is useful for decorated edge of curtain, table cloth, dress, etc. From 3mm to 5mm sequential pearl can be sewn with this foot.

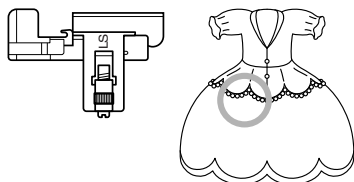

### Preparation

- Retract the knife (see CHAPTER 1 "Retracting knife").
- Attach the pearl sequence foot (see CHAPTER 1 "Attaching/ Removing presser foot").
- Set up the machine for 3 thread overlock stitch with one needle in the left position.  
The right needle should be removed.

## How to adjust the machine

- Adjust the stitch length according to the length as <A> or <B>. For example, 4mm stitch length means 4mm for <A> or <B>.

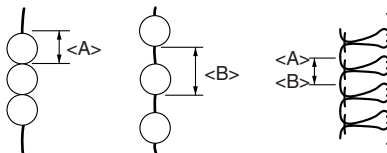

- Adjust stitch width 3 to 5mm.
- Adjust thread tension as follows:
  - Needle thread: slightly decrease
  - Over looper thread: slightly decrease
  - Under looper thread: slightly increase

## How to set fabric and pearl

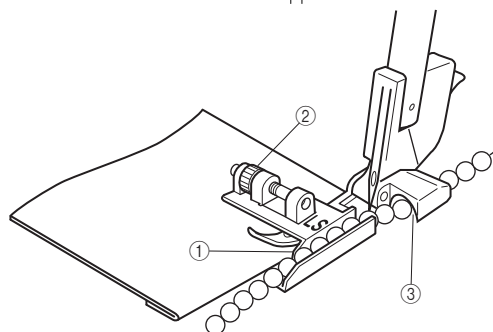
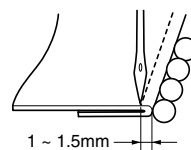

- Fold the fabric according to the line for pearl fitting.
- Place the fabric at needle dropping point keeping the folded edge with guide ①.
- Use the screw ② and adjust the clearance between folded edge needle so that it becomes 1mm to 1.5mm.
- Place the pearl through the guide just front of guide tunnel ③.

### Test sewing

- Sew turning hand wheel by hand until the pearl comes through the tunnel.
- Sew at slow speed while guiding the pearl and fabric by hand.
- Tie both end of thread at the beginning and end.

**NOTE:**

Thread tension is easy to loosen especially for small size pearl. Retract movable stitch tongue for better stitching.

## Piping foot

### Features

By using the piping foot, you can obtain piping at the edge of material. The piping is useful to decorate on edge of wares (pajamas, sports ware), cover for furniture, cushion, bag, etc.

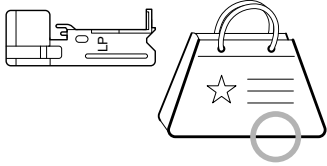

### Preparation

Attach the piping foot (see CHAPTER 1 "Attaching/Removing presser foot").

### Machine setting (type of stitch):

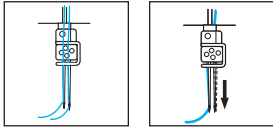

- 2 needle 4 thread overlock
- 1 needle 3 thread overlock (the right needle should be removed)

### How to adjust the machine

1. Set stitch length at 3mm. (standard position)
2. Set stitch width at 5 to 6mm
3. Adjust thread tension for ordinary overlock stitching (refer to CHAPTER 5 "Stitch Selection").

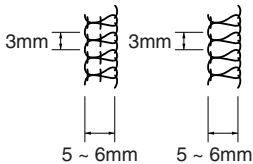

## How to set fabric and piping tape

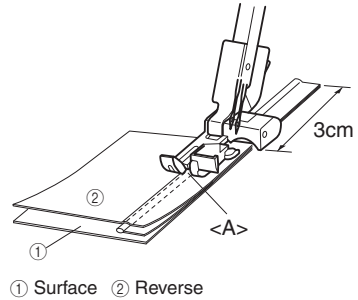

1. Put piping tape between the 2 pcs of fabric and adjust both edges of the fabric as illustrated. Keep 3cm piping tape over the edge of fabric for steady sewing. (The surface of fabric should be inside.)
2. Place fabric with piping tape under presser foot and put the piping tape into the groove <A> of piping foot and start sewing.

### Start sewing

1. Carefully guide the fabric and piping tape by hands during sewing.
2. Turn both sides of the fabric after sewing.

#### NOTE:

*For easy sewing, bast the both fabric and piping tape before sewing.*

*Piping sewing is difficult at an acute angle.*

*In case of wide piping tape, you should sew it with cutting the excess part.*

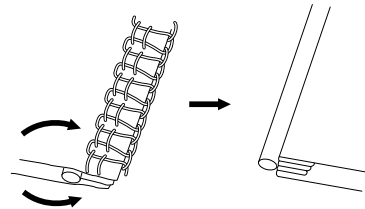

## Gathering foot

### Features

You can create beautiful gathers using the gathering foot on various garment and home decorating applications.

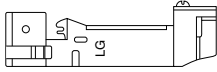

### Preparation

Attach the gathering foot (see CHAPTER 1 "Attaching/ Removing presser foot").

### Machine setting (type of stitch):

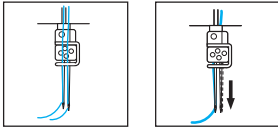

- 2 needle 4 thread overlock
- 1 needle 3 thread overlock (Either needle can be used.)

### How to set fabric

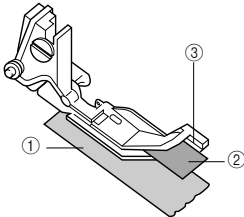

① Surface    ② Reverse

1. Raise the presser foot lever.
2. Turn the hand wheel so that the mark on the hand wheel is aligned to the line on the machine (see CHAPTER 1 "Turning direction of hand wheel").
3. Position the bottom piece of fabric (the fabric that will be gathered ① under the guide ③ just below the needle).
4. Position the top piece of fabric ② between the gathering foot and the guide ③ on top of the bottom fabric ①.
5. Lower the presser foot lever.

### Test sewing

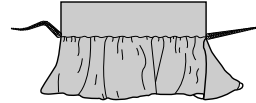

1. Set the stitch length to 3mm.
2. Set the differential feed ratio to 2.
3. Set the stitch width to 5mm.
4. Adjust the other settings to those used during normal overlock sewing.
5. Sew while keeping the fabric aligned with the fabric guide ③.
  - Adjust the size of the gathers by setting the stitch length between 2mm and 5mm.
  - Adjust the amount of fabric that is gathered by setting the differential feed ratio between 1.0 and 2.0.

#### NOTE:

*Do not pull or stretch the fabric.*

# SPECIFICATIONS

## Specifications

### Use

Fine to heavy materials

### Sewing speed

Maximum 1,300 stitches per minute

### Stitch width

2.3 mm to 7 mm (3/32 to 9/32 inch)

### Stitch length (pitch)

2 mm to 4 mm (5/64 to 5/32 inch)

### Needle bar stroke

25 mm (63/64 inch)

### Presser foot

Free presser type

### Presser foot lift

5 mm to 6 mm (3/16 to 15/64 inch)

### Needle

130/705H

### No. of needles and threads

Three/Four threads convertible

Two needles or single needle

### Machine net weight

5.6 kgs.

### Machine dimensions

33.5 cm (W) x 29.6 cm (H) x 28.2 cm (D)  
(Approx. 13-1/4 (W) x 11-11/16 (H) x 11-1/8 (D)  
inches)

Needle set 130/705H.

#80 (2)

#90 (2)

# SETTING RECORD

FABRIC	THREAD	NEEDLE	THREAD TENSION				NOTE  STITCH TYPE
			Left needle	Right needle	Upper-looper	Lower-looper	





Please visit us at <http://support.brother.com/> where you can get product support and answers to frequently asked questions (FAQs).