

Inhalt
Contents
Contenu

Inhoud
Contenido
Conteúdo

Contenuto
Содержание
目录

Einzelteilübersicht / Spare parts list / Liste des pièces détachées / Onderdelenoverzicht / Lista da piezas / Resumo de peça individual / Singoli componenti / Перечень деталей / 零件概览 3

Montagetips / Tips for assembly / Tuyaux pour le montage / Montagetips / Consejos para el montaje / "Dicas" para montagem / Consigli per il montaggio / Советы по сборке / 装配建议 5

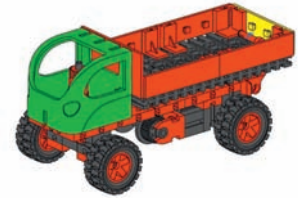

Abschleppwagen / Tow truck / Dépanneuse / Sleepwagen / Coche grúa / Carro reboque / Carro attrezzi / Буксирный автомобиль / 清障车 6

LKW mit Pritsche / Truck with bed / Camion-plateau / Vrachtauto met laadbak / Camión con caja / Caminhão com carga / Autocarro con pancaccio / Грузовик с бортовой платформой / 平板式载货汽车 8

Kipper / Dump truck / Camion à benne basculante / Kiepauto / Volcador / Caminhão basculante / Ribaltabile / Самосвал / 翻斗卡车 10

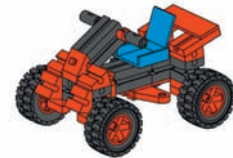
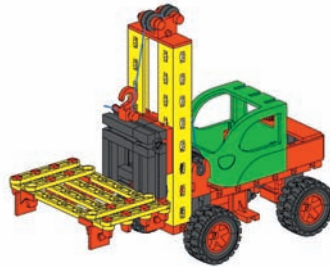
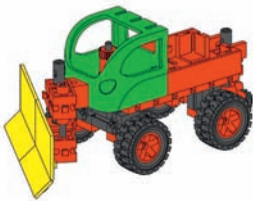

Schneepflug / Snow plow / Chasse-neige / Sneeuwploeg / Quitanieves / Removedor de neve / Spartineve / Снегоочиститель / 推雪车 13

Gabelstapler / Fork lift / Empileuse à fourche / Vorkheftruck / Carretilla elevadora / Empilhadeira de forquilha / Carrello a forcole / Вилочный погрузчик / 叉车 16

Quad / Квадрацикл / 沙滩车 20

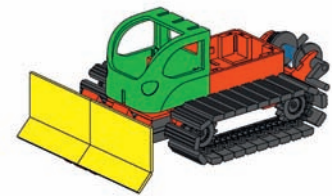
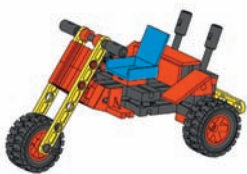

Trike / Trike / Trike / Trike / Triciclo motorizado / Triciclo / Trike / Трицикл / 三轮摩托车 22

Bergungsraupe / Track mounted recovery vehicle / Chenille de sauvetage / Bergingsvoertuig op rupsbanden / Oruga de salvamento / Lagarta de salvamento / Cingolato di salvataggio / Спасательный трактор / 履带式抢险车 25

Pistenraupe / Ski area grader / Chenille de damage des pistes / Pistebulldozer / Oruga de pistas / Lagarta de rodovias / Cingolato per pista / Патрак / 滑雪场扫雪车 28

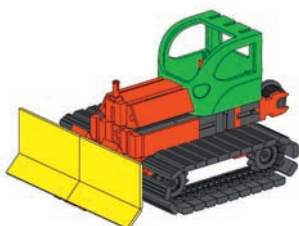

Planierraupe / Road grader / Bouteur / Rupsbulldozer / Oruga de nivelación / Patrola de lagarta / Bulldozer / Бульдозер / 推土机 31

Ventilator / Ventilating fan / Ventilateur / Ventilator / Ventilador / Ventilador / Ventola / Вентилятор / 风扇 35

Schraubzwinge / C-clamp / Serre-joint à serrage par vis / Bankschroef / Prensa de tornillo / Sargento / Morsa / Струбцина / 台钳 38

Inhalt
Contents
Contenu

Inhoud
Contenido
Conteúdo

Contenuto
Содержание
目录



Milchschaumer / Milk foamer / Mousseur à lait / Melkop-schuimer / Espumadera de leche / Espumador de leite / Cappuccinatore / Миксер / 牛奶打泡器 39



Fliehkraftregler / Centrifugal governor / Régulateur centrifuge / Centrifugaalkrachtregelaar / Regulador de fuerza centrífuga / Regulador de força centrífuga / Regolatore della forza centrifuga / Центробежный регулятор / 离心式调速器 42

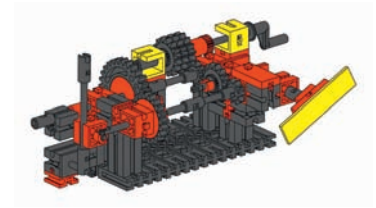

Schaltgetriebe / Manual transmission / Boîte de vitesses / Schakeloverbrenging / Cambio de velocidades / Caixa de câmbio / Cambio meccanico / Коробка передач / 变速器 45

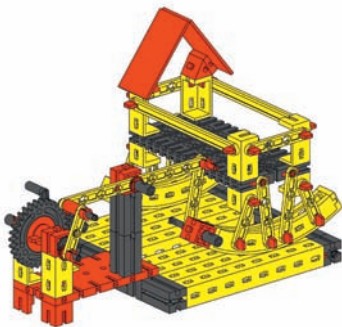

Wiege / Rocking cradle / Berceau / Weegschaal / Báscula / Berço / Culla / Весы / 摇篮 50

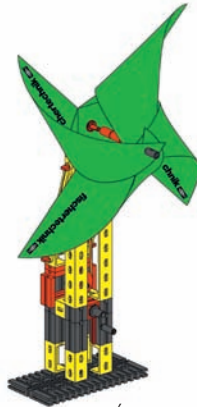

Windmaschine / Wind turbine / Éolienne / Windmachine / Máquina de viento / Máquina de vento / Macchina del vento / Ветряная машина / 通风机 56

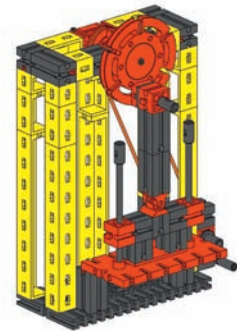

Stanze / Punch / Estampe / Stansmachine / Punzonadora / Punção / Pressa per coniare / Высечной пресс / 冲床 61

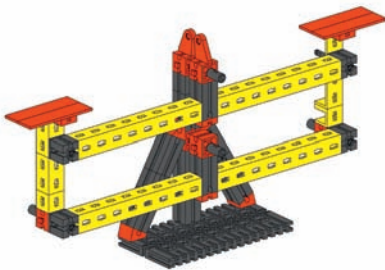

Balkenwaage / Beam balance / Balance romaine / Balansweegschaal / Balanza de brazos / Balança de travessa / Bilancia a braccio / Коромысловые весы / 天平 68

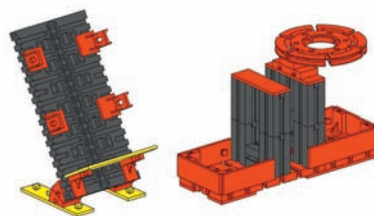

Schreibtischset / Desk set / Parure de bureau / Bureau set / Kit para escritorio / Conjunto de escrivaninha / Set per scrivania / Набор для письменного стола / 文具套件 71

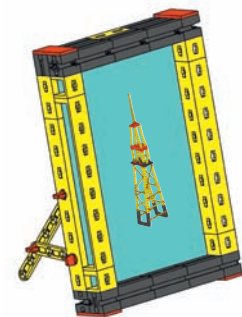

Bilderrahmen / Picture frame / Cadre pour image / Fotolijst / Marco de cuadro / Moldura de quadro / Cornice / Фоторамка / 像框 74



Schaukelstuhl / Rocking chair / Fauteuil à bascule / Schommelstoel / Mecedora / Cadeira de balanço / Sedia a dondolo / Кресло-качалка / 摇椅 77

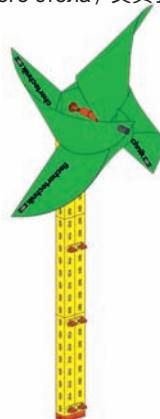

Windrad / Windmill / Roue éolienne / Windmolen / Rueda de viento / Moinho de vento / Girandola / Ветряное колесо / 风车 79

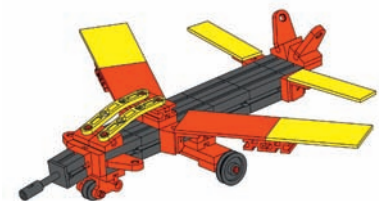

Düsenjet / Jet airplane / Avion à réaction / Straaljager / Avión a reacción / Avião a jato / Aviogetto / Реактивный самолёт / 喷气式飞机 81

Inhalt
Contents
Contenu



Flugplatz / Airport / Terrain d'aviation / Vliegveld / Aeródromo / Aeroporto / Aeroport / Аэродром / 机场 83

Inhoud
Contenido
Conteúdo



Baustelle / Construction site / Chantier / Bouwplaats / En la obra / Canteiro de obras / Cantiere / Стройплощадка / 建筑工地 94

Contenuto
Содержание
目录



Windmühle mit Hammerschmiede / Windmill with hammer forge / Moulin à vent avec forge à marteaux-pilons / Windmolen met hamersmederij / Molino de viento con forja de martillos / Moinho de vento com martelo de ferro / Mulino a vento con fucina / Ветряная мельница с молотом / 风车和锤锻 105



Flugzeugkarussell / Airplane merry-go-round / Manège avions / Draaimolen met vliegtuigjes / Tiovivo de aviones / Carrousel de aviões / Giostra con aerei / Карусель с самолётами / 旋转飞机 113

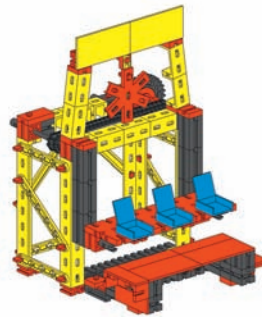

Kirmesschaukel / Fair swing / Manège balance / Kermisshommel / Columpio de feria / Balanço de quermesse / Altalena per lunapark / Ярмарочные качели / 游乐场摇架 120



Karussell / Merry-go-round / Manège / Draaimolen / Tiovivo / Carrousel / Giostra / Карусель / 旋转臂 127



Flaschenzug / Block and tackle / Palan / Takel / Aparejo / Carregador de garrafas / Paranco / Подъёмный кран / 滑轮起重设备 135



Raupenkran / Track mounted crane / Grue mobile sur chenilles / Kraan op rupsbanden / Grúa de orugas / Guindaste de lagarta / Gru di recupero materiale / Гусеничный кран / 履带式吊车 142



Hafenkran / Dockside crane / Grue de quai / Havenkraan / Grúa de muelle / Guindaste portuário / Gru portuale / Порттовый кран / 港口吊车 147



















Portalkran / Portal crane / Grue à portique / Portaalkraan / Grúa de pórtico / Guindaste de portão / Gru a portale / Портальный кран / 龙门吊车 154

















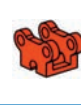

Turm / Tower / Tour / Toren / Torre / Torre / Torre / Башня / 塔 162

Einzelteilübersicht
Spare parts list
Liste des pièces détachées

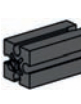















	19 318 1 x
	31 010 3 x
	31 011 8 x
	31 019 1 x
	31 021 1 x
	31 023 2 x
	31 058 3 x
	31 061 2 x
	31 426 3 x
	31 436 3 x
	31 597 2 x
	31 673 1 x
	31 674 6 x
	31 690 3 x
	31 790 46 x
	31 848 6 x
	31 915 1 x

Onderdelenoverzicht
Lista da piezas
Resumo de peça individual





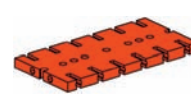

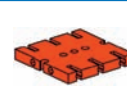

	31 981 2 x
	31 982 10 x
	31 983 4 x
	31 997 1 x
	31 998 1 x
	31 999 1 x
	32 064 7 x
	32 071 8 x
	32 085 1 x
	32 321 1 x
	32 850 3 x
	32 869 1 x
	32 870 1 x
	32 879 10 x
	32 881 12 x
	35 031 3 x
	35 049 2 x

Singoli componenti
Перечень деталей
零件概览

	35 051 3 x
	35 053 4 x
	35 054 6 x
	35 055 6 x
	35 059 6 x
	35 060 2 x
	35 061 2 x
	35 063 2 x
	35 064 2 x
	35 065 3 x
	35 066 2 x
	35 073 5 x
	35 087 1 x
	35 088 2 x
	35 113 1 x
	35 129 1 x
	35 695 4 x

	35 797 2 x
	35 945 3 x
	35 973 1 x
	35 977 1 x
	35 981 1 x
	36 227 3 x
	36 264 1 x
	36 294 6 x
	36 298 2 x
	36 299 8 x
	36 323 43 x
	36 324 2 x
	36 334 4 x
	36 336 2 x
	36 576 1 x
	36 586 4 x
	36 593 1 x









Einzelteilübersicht
Spare parts list
Liste des pièces détachées

	36 819 1 x
	37 237 7 x
	37 238 4 x
	37 468 6 x
	37 527 1 x
	37 636 3 x
	37 679 6 x
	38 225 1 x
	38 240 2 x

Onderdelenoverzicht
Lista da piezas
Resumo de peça individual

	38 241 4 x
	38 242 6 x
	38 249 2 x
	38 258 2 x
	38 277 1 x
	38 411 1 x
	38 415 2 x
	38 423 8 x
	38 428 1 x

Singoli componenti
Перечень деталей
零件概览

	38 545 5 x
	128 659 92 x
	130 593 4 x
	136 775 1 x
	137 103 1 x
	137 357 1 x
	142 251 4 x
	143 231 4 x
	144 446 1 x

Sicherheitshinweise
Safety Information
Consignes de sécurité

Veiligheidsrichtlijnen
Indicaciones de seguridad
Observações sobre segurança

Informazioni per la sicurezza
Указания по технике безопасности
安全指南

- Alle Einzelteile, insbesondere bewegliche Teile sind falls notwendig zu warten und zu reinigen.
- All components, especially moving parts, should be maintained and cleaned as necessary.
- Toutes les pièces détachées et en particulier les pièces mobiles, sont, si nécessaire, à entretenir et à nettoyer.
- Alle onderdelen, vooral de bewegende delen, kunnen, indien noodzakelijk, onderhouden en gereinigd worden.
- Es necesario limpiar y mantener en buen estado todas las diferentes piezas - especialmente las piezas móviles.

- Achtung**
Verletzungsgefahr an Bauteilen mit funktionsbedingten scharfen Kanten und Spitzen!
- Caution**
Be careful not to hurt yourself on components with sharp or pointed edges!
- Attention**
Risque de blessure sur les éléments comportant des arêtes et o pointes vives indispensables au bon fonctionnement!
- Let op**
U kunt zich bezeren aan bouwstenen met scherpe randen of punten!
- Attenzione**
Esiste il pericolo di lesione con i pezzi di costruzione che hanno bordi e punte spigolosi necessari per la funzionalità del pezzo!

- Caso necessário, todas as peças individuais, especialmente peças móveis, tem que ser submetidas à manutenção e ser limpas.
- Se necessario, tutti i singoli componenti, soprattutto le parti mobili, si devono eventualmente sottoporre a manutenzione e pulizia.
- Все детали, особенно подвижные, требуют ухода и чистки.
- 必要时应保养和清洁所有零件，尤指运动部件。
- Atenção**
Perigo de ferimentos em peças componentes com cantos vivos e pontas obrigatórias para o funcionamento!
- Attenzione**
Pericolo di lesioni dovute a componenti con spigoli vivi e punte per motivi funzionali!
- Будьте осторожны**
Об острые края деталей и и наконечники можно порезаться!
- 注意**
因功能需要而带有锋利的棱边和尖角的部件可能会带来受伤危险!