

PHILIPS

Clock Radio

3000 Series

R3306



 www.philips.com/welcome

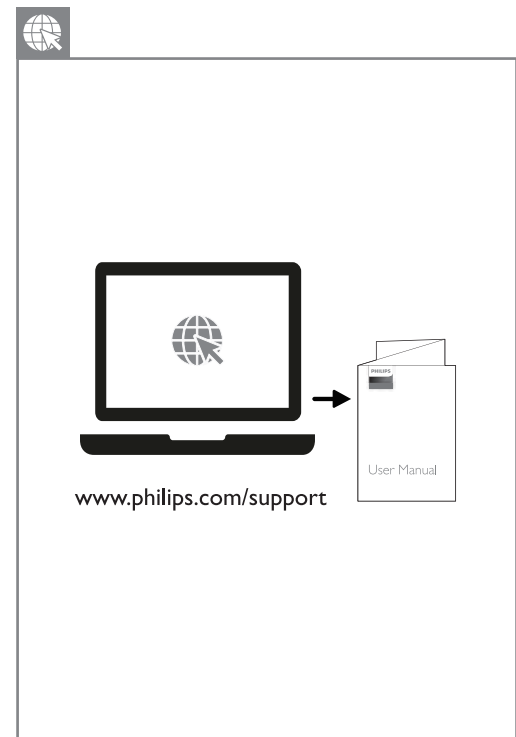
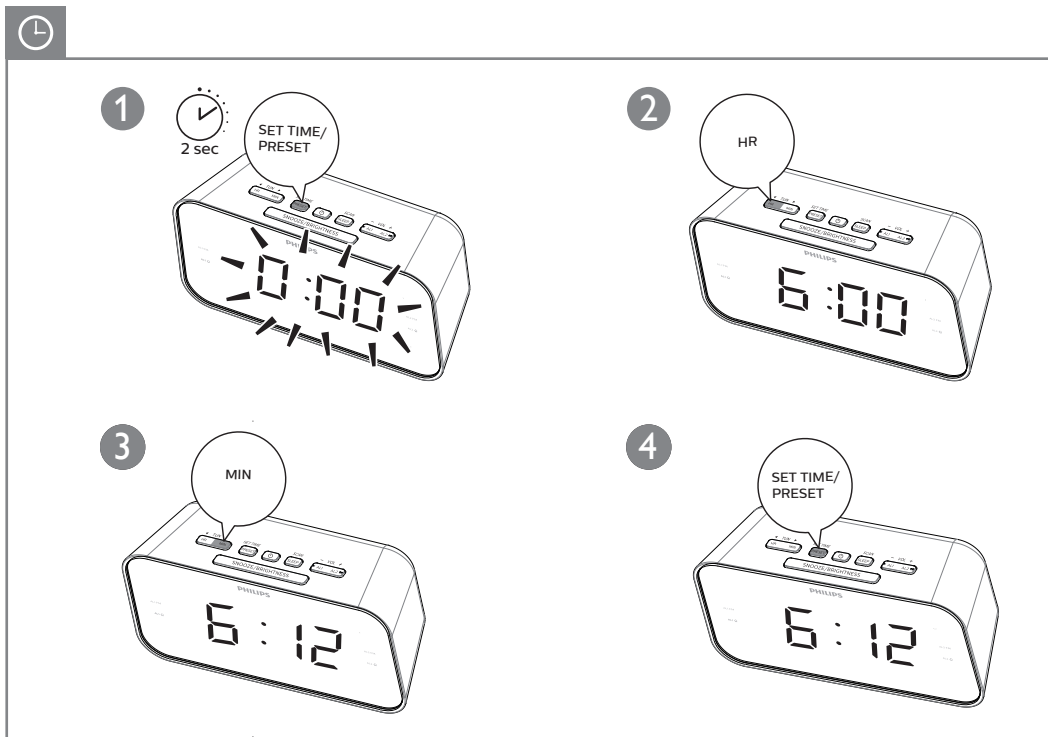
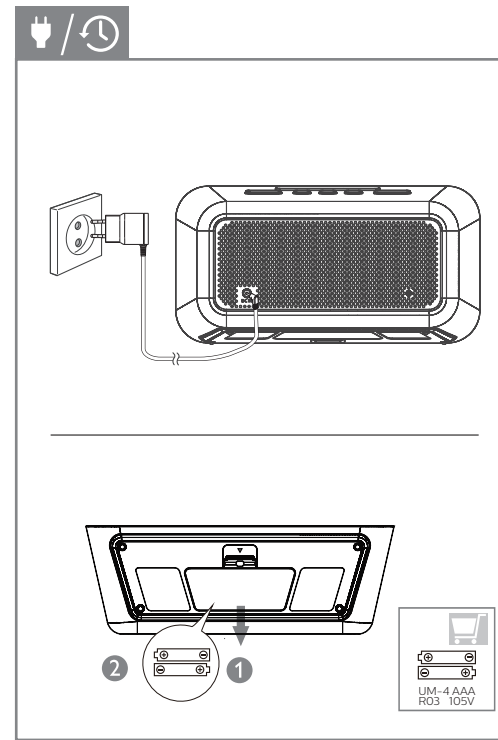
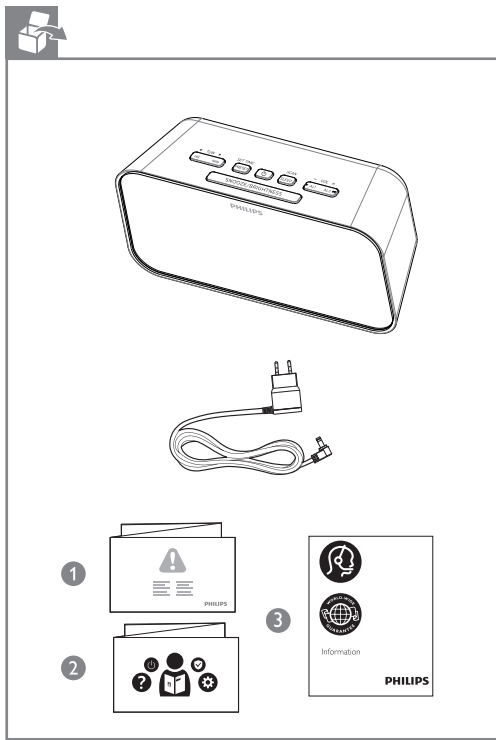

2021 © MMD Hong Kong Holding Limited. All rights reserved. Specifications are subject to change without notice.
Philips and the Philips Shield Emblem are registered trademarks of Koninklijke Philips N.V. and are used under license. This product has been manufactured by and is sold under the responsibility of MMD Hong Kong Holding Limited or one of its affiliates, and MMD Hong Kong Holding Limited is the warrantor in relation to this product.



TAR3306_12_QSG_V1.0

