



## EN ■ Steam iron

*Translation of the original manual*

**READ CAREFULLY AND STORE FOR FUTURE USE.****General warnings**

- This appliance may be used by children 8 years of age and older and by persons with physical or mental impairments or by inexperienced persons, if they are properly supervised or have been informed about how to use the product in a safe manner and understand the potential dangers.
- Children must not play with the appliance. Cleaning and maintenance performed by the user must not be performed by unsupervised children.
- In the event that the power cord is damaged, have it repaired at a professional service centre to prevent causing a dangerous situation. It is forbidden to use the appliance if it has a damaged power cord.
- The iron must not be left without supervision when connected to a power socket.
- Always disconnect the iron from the power socket when leaving it without supervision, when filling up or emptying the water tank and when you have finished using it. Turn off the steam function before disconnecting the iron from the power socket.
- The water tank lid must not be open when ironing.
- The iron may be used only on a stable, even surface. This also applies for putting down the iron. When putting the iron down on to the stand, check that the surface on which the stand is located is stable.

- The iron must not be used if it has fallen on the floor, exhibits visible signs of damage or if it is leaking.
- The iron must not be left within the reach of children younger than 8 years of age, when it is connected to mains electricity or while it is cooling down.



### **ATTENTION:**

The surfaces of the iron may become hot during use.

#### **Electrical safety**

- Before connecting this iron to a power socket, make sure the voltage stated on its rating label corresponds to the voltage in your power socket.
- Connect the iron only to a properly grounded socket. Do not use an extension cord.
- Do not touch the iron with wet or damp hands when it is connected to a power socket.
- To avoid potential injury by electrical shock, do not clean the iron under running water, do not spray it with water and do not submerge it in water or any other liquid.
- Ensure that the power cord does not come into contact with water, moisture or a heated surface.
- Do not place heavy items on the power cord. Make sure the power cord does not hang over the edge of a table and that it is not touching a hot surface or sharp objects.
- Disconnect the iron from the power socket by gently pulling the plug of the power cord, and not the power cord itself. Otherwise, this could damage the power cord or the socket.
- Do not pull or carry the iron by the power cord.
- To avoid the danger of injury by electrical shock, do not repair the iron yourself or make any adjustments to it. Have all repairs or adjustments performed at an authorised service centre. By tampering with the product you risk voiding your legal rights arising from unsatisfactory performance or quality warranty.
- If the power cord is damaged, have it replaced at a professional service centre. It is forbidden to use the iron if it has a damaged power cord or plug.

#### **Safety during use**

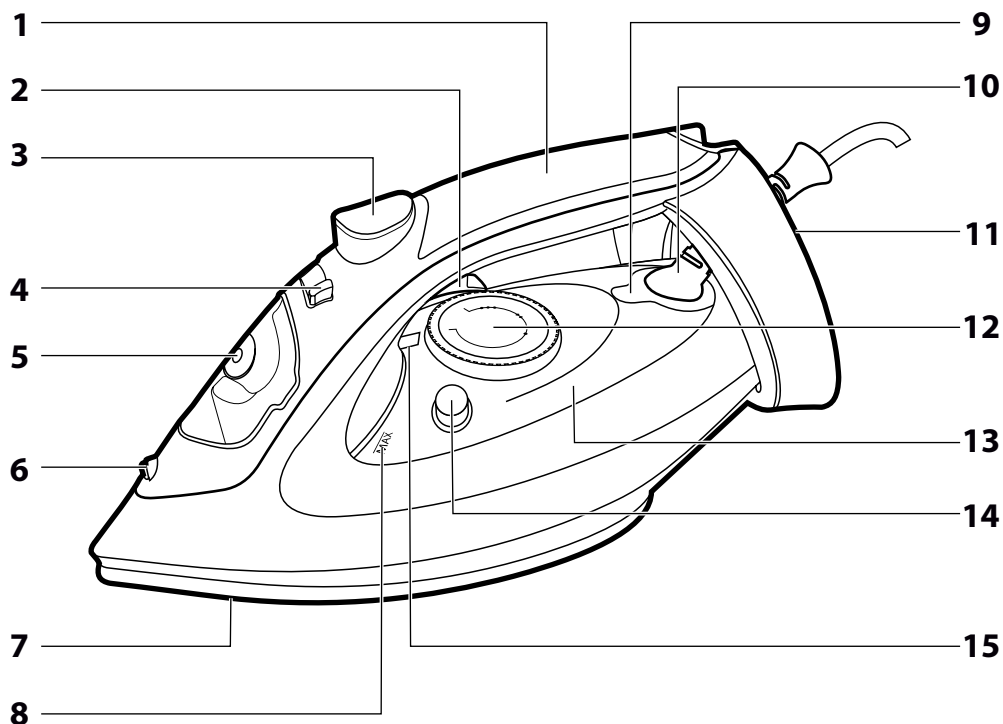

- This iron is designed for home use. Do not use it in industrial surroundings or outdoors.
- Do not place the iron on or near an electric or gas stove or other sources of heat.
- Never iron clothing on a body.
- Do not touch the hot ironing surfaces. Otherwise, this could cause burns.
- Never fill the water tank directly underneath a water tap. Always use the supplied container for filling the water tank. Never add vinegar, descaling agents or other additives to the water tank.
- Prior to cleaning or any other handling of the iron that you have disconnected from the power socket, allow the soleplate to cool down.

**A**



- Prior to using this appliance, please read the user's manual thoroughly, even in cases, when one has already familiarised themselves with previous use of similar types of appliances. Only use the appliance in the manner described in this user's manual. Keep this user's manual in a safe place where it can be easily retrieved for future use. In the event that you hand this appliance over to somebody else, make sure to also include this user's manual.
- Carefully unpack the appliance and take care not to throw away any part of the packaging before you find all its parts. We recommend saving the original cardboard box, packaging material, purchase receipt and responsibility statement of the vendor or warranty card for at least the duration of the legal liability for unsatisfactory performance or quality. In the event of transportation, we recommend that you pack the appliance in the original box from the manufacturer.

### DESCRIPTION OF THE APPLIANCE

- |   |  |
|---|--|
| <b>A1</b> Handle  | <b>A10</b> Swivel power cord end                             |
| <b>A2</b> Steam impulse button  | Limits twisting and tangling of the power cord.              |
| <b>A3</b> Water spraying button   | <b>A11</b> Stand   |
| <b>A4</b> Steam release regulator   | <b>A12</b> Temperature control knob                          |
|  – Steam release off     | <b>A13</b> Transparent easy-to-fill water tank               |
|  – Steam release on full | <b>A14</b> Self-Clean button for removing limescale deposits |
| <b>A5</b> Water tank cap  | <b>A15</b> Regulator setting mark                            |
| <b>A6</b> Water spraying nozzle   | <b>A16</b> Water tank filling container (not shown)          |
| <b>A7</b> Ceramic ironing soleplate   |  |
| <b>A8</b> Maximum water level mark  |  |
| <b>A9</b> Heating indicator   |  |

### BEFORE FIRST USE

- Before first use, remove all packaging materials including promotion stickers and labels from the iron. Wipe the soleplate with a lightly dampened cloth before first use and then wipe dry.
- Using a dry or lightly dampened cloth, also clean the outer parts of the iron and then wipe it dry. Never submerge the iron in water or any other liquid!

### OPERATION

#### FILLING THE WATER TANK

- Before filling the water tank, the iron must be disconnected from the power socket and the steam release regulator must be set to position  (steam output off).
- The iron is intended to be filled with tap water. Limescale deposits may quickly form, if you live in an area with hard or very hard water. To extend the lifetime of the iron, it is recommended to mix the tap water with distilled water. The ratio of distilled water to tap water is as follows:
  - 1:1 for medium hard water
  - 2:1 for hard water
  - 3:1 for very hard water



**Note:**  
Your local water utility will provide information about the water hardness in your area.







**Attention:**  
Never add water softeners, vinegar, starch, descaling agents, perfumes or other additives to the water.

- Fill the included container with water. Flip open the cap of the filling opening and slightly tilt the iron. Slowly pour the water from the container through the filling opening into the water tank. Make sure that the water level does not rise above the maximum water level mark on the water tank. To correctly assess the water level, it is necessary to stand the iron in the upright position.
- After filling the water tank, close the filling opening lid and put the iron in the upright position. In the event that you spilled any water while filling, thoroughly dry the iron.

### SETTING TEMPERATURE ACCORDING TO TEXTILE

- When setting the temperature, pay attention to the material composition of the textile. It is recommended to sort the laundry according to the international symbols shown on the textile, according to the type of textile or according to the recommendations of the manufacturer on the label. The number of dots inside the international symbol corresponds to the number of dots on the temperature control knob.

INTERNATIONAL SYMBOL	FABRIC TYPE	SUITABLE FOR		
		CONTINUOUS STEAMING	STEAM BOOST	SPRAYING
	Synthetic fabric (acrylic, acetate, polyester, viscose, etc.)	No	No	Yes
	Cotton with addition of other types of fibres, silk, wool, wool with addition of other types of fibres, etc.	No	No	Yes
	Corduroy, cotton, denim and linen	Yes	Yes	No
	Fabric, that should not be ironed			

### TURNING ON

- Connect the power cord to a power socket. Turn the temperature control knob to the required temperature setting. Indicator **A9** will be lit, which means that the iron is heating up. When the iron's thermostat reaches the correct temperature, the heating indicator will turn off. The iron is now ready for use.



**Note:**  
The heating indicator will spontaneously turn on and off during use. This is completely normal. In the event that the temperature control knob was not set to the MIN position the after previous use of the iron, and was left at one of the temperatures, the heating indicator will be lit immediately when the power cord is plugged into the power socket.

### IRONING WITHOUT STEAMING

- This function enables the use of the iron with or without water in the water tank, however, the steam release regulator must be set to position  (stream output off).





**Note:**  
When used for the first time, the iron may emit smoke, which is non-toxic. This is normal. After a short time, the iron will stop emitting smoke.

### IRONING WITH STEAM



**Attention:**  
In order to iron with steam, the water tank must be filled with water.

### CONTINUOUS STEAMING FUNCTION

- If you wish to iron with steam, slide the steam release regulator from position  (steam release off) towards position  (steam release on). Select the position based on the required steam intensity. The more the steam regulator is moved to the right, the stronger the steam intensity.
- Wait until the heating indicator turns off.
- The steam release regulator can be moved at any time while ironing.
- For all standard ironing, it is recommended to use the middle settings of the steam release regulator. Only when ironing linen fabrics, strong silk or similar fabrics it is recommended to set the steam release regulator to maximum.



**Note:**  
The iron continuously emits steam only if you hold it in a horizontal position. You can stop the release of steam by standing the iron upright.

- Setting the steam release regulator to position  (steam output off), deactivates the steam function.

### STEAM IMPULSE FUNCTION

- Use this function when ironing with continuous steam is insufficient. Press the steam impulse button to generate a strong flow of steam, which can straighten out even very crumpled up textiles.
- Wait at least 3 seconds before pressing the button again. If the heating indicator starts flashing, wait until it turns off and only then press the button.
- The steam impulse function can also be used when ironing hanging textiles (e.g. curtains, garments hanging on coat hangers, etc.). Use one hand to gently tension the fabric and vertically move the iron from bottom up. Press the steam impulse button to achieve vertical bursts of steam. Do not hold the steam impulse button continuously and do not consecutively use it more than 10 times.

**Attention:**

Do not use the steam function for silk and synthetics so as not to damage the fabric.

**WATER SPRAYING FUNCTION**

- The water spraying function can be used with any ironing method. It serves to moisten the fabric and effectively helps with ironing heavily crumpled textiles.
- Make sure that there is a sufficient amount of water in the water tank and turn the iron so that its front side points towards the location that you wish to spray.
- Press the water spraying button (👉). Water will spray out of the nozzle on the front side.

**Note:**

When using the water spraying function for the first time or when you have not used the iron for a long time, it will be necessary to press the water spraying button several times before the nozzle starts working correctly.

**DRIP-STOP SYSTEM**

The iron is equipped with the Drip-Stop system, which automatically stops water supply when the set temperature is insufficient for generating steam and thereby prevents potential dripping of hot water out of the steam outlets.

**ANTI-CALC SYSTEM**

This iron is equipped with a permanent Anti-Calc filter, which limits the formation of limescale deposits inside the iron. This filter cannot be deactivated. The effectiveness of the filter depends on the hardness of the water used.

**AUTOMATIC SHUT-OFF FUNCTION**

- The iron will shut off automatically when left 8 minutes without movement in the upright position, or after 30 seconds without movement in the horizontal position or when tilted over on one of its sides.

**Attention:**

Despite the iron being equipped with an automatic shut-off function, for safety reasons, never leave it without supervision when it is connected to a mains power socket.

**TURNING OFF**

- When you have finished using the iron, stand it upright. Set the steam release regulator to position  (steam release off). This will deactivate the steam function.
- Set the temperature control knob to the MIN position.
- Disconnect the power cord from the power socket and allow the soleplate to cool down. After the soleplate has cooled down, clean the iron according to the instructions in chapter Cleaning and maintenance.

**TIPS FOR QUALITY IRONING**

- When the drum of the washing machine is overfilled with a large amount of laundry, the laundry may become excessively crumpled, making it harder to iron. Try filling the washing machine with a smaller amount of laundry or set a lower spinning speed.
- If you are ironing fabrics from blended materials (e.g. 40 % wool and 60 % synthetic material), set the temperature according to the material which is ironed at a lower temperature.
- If you do not know the composition of the fabric, identify the suitable temperature setting by ironing a piece of the fabric from the underside. Start by setting a low temperature and gradually increase it until the ideal temperatures is achieved.
- Never iron over places that have sweat marks or other stains. The high temperature fixes the stain in place, making it difficult to remove.
- To avoid silk, wool and synthetic fabrics from being shiny after ironing, iron them from the underside.
- Some materials are easier to iron when they are lightly damp.
- Spray fine fabrics before ironing them or iron them under a lightly dampened wiping cloth.

**CLEANING AND MAINTENANCE****CLEANING AFTER EVERY USE**

- Before cleaning it, turn the iron off according to the instructions described previously. The iron must be disconnected from the power socket and cooled down. Open the water tank cap and then empty out the remaining contents of the water tank over a sink. Close the cap again.
- In the event that the soleplate or the surface of the iron is dirty, wipe with a lightly dampened cloth and then wipe dry.
- For cleaning, do not use steel wool, solvents or cleaning products with an abrasive effect, etc. to prevent damaging the surface being cleaned. Do not submerge the iron in water when cleaning it.

**REMOVING LIMESCALE DEPOSITS**

- For the removal of limescale deposits from the inner part of the soleplate, the iron is equipped with a Self-Cleaning function. Use this function regularly at least once every 14 days.
- Disconnect the iron from the power socket and set the steam release regulator to position  (steam release off).
- Fill the water tank with clean water up to the maximum water level mark. Connect the iron to a power socket and set the temperature control knob to the MAX position. Wait until the heating indicator turns off. Then disconnect the iron from the power supply again.
- Hold the iron in a horizontal position above the sink. Press the Self-Clean button **A14** and hold it down. Steam and hot water will start to be released from the soleplate. At the same time also limescale deposits from the inner parts of the soleplate will be removed. Tilt the iron from side to side several times until the water tank is completely emptied out. After emptying it out, release the button **A14**. You may repeat this process once more if necessary.
- Connect the iron to a power socket and allow it to heat up once more to the maximum temperature in order to dry out the soleplate. Iron over a piece of unneeded fabric to remove any water stains that may have formed on the soleplate during the cleaning process. Unplug the iron from the power socket and allow it to cool down.

**STORAGE**

- After you have finished ironing, pour out any unused water from the water tank (careful, it may be hot), or allow it to evaporate if necessary and allow the iron to cool down. Set the steam release regulator to position  (steam release off). Wind the power cord around the stand, making sure that the power cord is not touching the soleplate, and then stand the iron on the stand **A8**.

**Attention:**

Keep the stored iron away from extreme temperatures, direct sunlight and excessive humidity and do not store it in an overly dusty environment. Do not place anything on to the stored iron.

**TECHNICAL SPECIFICATIONS**

Rated voltage range .....	220–240 V AC
Rated frequency.....	50/60 Hz
Rated power input .....	2.600-3.100 W
Continuous steam output.....	35 g/min
Steam impulse.....	170 g/min
Water tank capacity .....	280 ml
Dimensions (length x width x height) .....	300 mm x 125 mm x 135 mm
Weight.....	1.2 kg

Changes to text and technical parameters are reserved.

**INSTRUCTIONS AND INFORMATION REGARDING THE DISPOSAL OF USED PACKAGING MATERIALS**

Dispose of used packaging material at a site designated for waste in your municipality.

**DISPOSAL OF USED ELECTRICAL AND ELECTRONIC EQUIPMENT**

This symbol on products or original documents means that used electric or electronic products must not be added to ordinary municipal waste. For proper disposal, renewal and recycling, hand these products over to determined collection points. Alternatively, in some European Union states or other European countries you may return your appliances to the local retailer when buying an equivalent new appliance.

Correct disposal of this product helps save valuable natural resources and prevents potential negative effects on the environment and human health, which could result from improper waste disposal. Ask your local authorities or collection facility for more details.

In accordance with national regulations penalties may be imposed for the incorrect disposal of this type of waste.

**For business entities in European Union states**

If you want to dispose of electric or electronic devices, ask your retailer or supplier for the necessary information.

**Disposal in other countries outside the European Union.**

This symbol is valid in the European Union. If you wish to dispose of this product, request the necessary information about the correct disposal method from the local council or from your retailer.



This product meets all the basic requirements of EU directives related to it.