

Lenovo V330/V130 Hardware Maintenance Manual

Lenovo[™]

Notes:

- Before using this information and the product it supports, be sure to read the general information under “Notices” on page 90.
- This manual applies to the following models: Lenovo V330-15ISK/Lenovo V330-15IKB/Lenovo V130-15IGM/Lenovo V130-15IKB.
The illustrations used in this manual are for Lenovo V330-15IKB unless otherwise stated.

First Edition (Oct. 2017)

© Copyright Lenovo 2017. All rights reserved.

LIMITED AND RESTRICTED RIGHTS NOTICE: If data or software is delivered pursuant a General Services Administration “GSA” contract, use, reproduction, or disclosure is subject to restrictions set forth in Contract No. GS-35F-05925.

© 2017 Lenovo

Contents

About this manual	iv
Safety information	1
General safety	2
Electrical safety	3
Safety inspection guide	5
Handling devices that are sensitive to electrostatic discharge	6
Grounding requirements	6
Safety notices: multilingual translations	7
Laser compliance statement	14
Important service information	16
Strategy for replacing FRUs	16
Strategy for replacing a hard disk drive	17
Important notice for replacing a system board	17
Important information about replacing RoHS compliant FRUs	18
General checkout	19
What to do first	20
Power system checkout	21
Checking the AC adapter	21
Checking operational charging	22
Checking the battery pack	22
Related service information	23
Restoring the factory contents by using Recovery system	23
Restore of factory default	23
Passwords	24
Power-on password	24
Hard-disk password	24
Administrator password	24
Power management	25
Putting the computer to sleep or shutting it down	25
Putting your computer to sleep	25
Shutting down the computer	25
Lenovo V330-15ISK/Lenovo V330-15IKB/ Lenovo V130-15IGM/Lenovo V130-15IKB	26
Specifications	26
Status indicators	28
Fn key combinations/Hotkeys	30
FRU replacement notices	31
Screw notices	31
Removing and replacing an FRU	32
1010 Removable module (on select models)	33
1020 Base cover	35
1030 Battery pack	38
1040 Hard disk drive	40
1050 Solid state disk	42
1060 PCI Express Mini Card for wireless LAN	43
1070 DIMM	45
1080 LED board	46
1090 Speaker	47
1100 IO board	48
1110 Fingerprint module (on select models)	49
1120 Fan assembly	51
1130 Heat sink	53
1140 System board	55
1150 DC in cable and touchpad module	58
1160 Upper case	61
1170 LCD unit	63
1180 EDP cable and integrated camera (on select models)	65
1190 LCD hinges	67
Locations	69
Front and right-side view	69
Bottom and left-side view	70
Parts list	71
Overall	72
LCD FRUs	84
Miscellaneous parts	86
AC adapters	86
Screws	86
Power cords	87
Notices	90
Trademarks	91

About this manual

This manual contains service and reference information for the following Lenovo products:

**Lenovo V330-15ISK/Lenovo V330-15IKB/Lenovo V130-15IGM/
Lenovo V130-15IKB**

Use this manual to troubleshoot problems.

The manual is divided into the following sections:

- The common sections provide general information, guidelines, and safety information required for servicing computers.
- The product-specific section includes service, reference, and product-specific parts information.

Important:

This manual is intended only for trained servicers who are familiar with Lenovo products. Use this manual to troubleshoot problems effectively.

Before servicing a Lenovo product, make sure to read all the information under “Safety information” on page 1 and “Important service information” on page 16.

Safety information

This chapter presents the following safety information that you need to get familiar with before you service a Lenovo V330-15ISK/Lenovo V330-15IKB/Lenovo V130-15IGM/Lenovo V130-15IKB computer:

- “General safety” on page 2
- “Electrical safety” on page 3
- “Safety inspection guide” on page 5
- “Handling devices that are sensitive to electrostatic discharge” on page 6
- “Grounding requirements” on page 6
- “Safety notices: multilingual translations” on page 7
- “Laser compliance statement” on page 14

General safety

Follow these rules below to ensure general safety:

- Observe a good housekeeping in the area where the machines are put during and after the maintenance.
- When lifting any heavy object:
 1. Make sure that you can stand safely without slipping.
 2. Distribute the weight of the object equally between your feet.
 3. Use a slow lifting force. Never move suddenly or twist when you attempt to lift it.
 4. Lift it by standing or pushing up with your leg muscles; this action could avoid the strain from the muscles in your back. Do not attempt to lift any object that weighs more than 16 kg (35 lb) or that you think is too heavy for you.
- Do not perform any action that causes hazards to the customer, or that makes the machine unsafe.
- Before you start the machine, make sure that other service representatives and the customer are not in a hazardous position.
- Please remove covers and other parts in a safe place, away from all personnel, while you are servicing the machine.
- Keep your toolcase away from walk areas so that other people will not trip over it.
- Do not wear loose clothing that can be trapped in the moving parts of the machine. Make sure that your sleeves are fastened or rolled up above your elbows. If your hair is long, fasten it.
- Insert the ends of your necktie or scarf inside clothing or fasten it with the nonconductive clip, about 8 centimeters (3 inches) from the end.
- Do not wear jewelry, chains, metal-frame eyeglasses, or metal fasteners for your clothing.

Attention: Metal objects are good electrical conductors.
- Wear safety glasses when you are hammering, drilling, soldering, cutting wire, attaching springs, using solvents, or working in any other conditions that may be hazardous to your eyes.
- After service, reinstall all safety shields, guards, labels, and ground wires. Replace any safety device that is worn or defective.
- Reinstall all covers correctly before returning the machine to the customer.
- Fan louvers on the machine help to prevent the overheating of internal components. Do not obstruct fan louvers or cover them with labels or stickers.

Electrical safety

Observe the following rules when working on electrical equipments.

Important:

Use only approved tools and test equipments. Some hand tools have handles covered with a soft material that does not insulate you when working with live electrical currents.

Many customers have rubber floor mats near their machines that contain small conductive fibers to decrease electrostatic discharges. Do not use such kind of mat to protect yourself from electrical shock.

- Find the room emergency power-off (EPO) switch, disconnecting switch or electrical outlet. If an electrical accident occurs, you can then operate the switch or unplug the power cord quickly.
- Do not work alone under hazardous conditions or near the equipment that has hazardous voltages.
- Disconnect all power before:
 - Performing a mechanical inspection
 - Working near power supplies
 - Removing or installing main units
- Before you start to work on the machine, unplug the power cord. If you cannot unplug it, ask the customer to power-off the wall box that supplies power to the machine, and to lock the wall box in the off position.
- If you need to work on a machine that has exposed electrical circuits, observe the following precautions:
 - Ensure that another person, familiar with the power-off controls, is near you.

Attention: Another person must be there to switch off the power, if necessary.
 - Use only one hand when working with powered-on electrical equipment; keep the other hand in your pocket or behind your back.

Attention: An electrical shock can occur only when there is a complete circuit. By observing the above rule, you may prevent a current from passing through your body.
 - When using testers, set the controls correctly and use the approved probe leads and accessories for that tester.
 - Stand on suitable rubber mats (obtained locally, if necessary) to insulate you from grounds such as metal floor strips and machine frames.

Observe the special safety precautions when you work with very high voltages; instructions for these precautions are in the safety sections of maintenance information. Be extremely careful when you measure the high voltages.

- Regularly inspect and maintain your electrical hand tools for safe operational condition.
- Do not use worn or broken tools and testers.
- Never assume that power has been disconnected from a circuit. First, check it to make sure that it has been powered off.

// *Lenovo V330-15ISK/Lenovo V330-15IKB/Lenovo V130-15IGM/ Lenovo V130-15IKB Hardware Maintenance Manual*

- Always look carefully for possible hazards in your work area. Examples of these hazards are moist floors, nongrounded power extension cables, power surges, and missing safety grounds.
- Do not touch live electrical circuits with the reflective surface of a plastic dental mirror. The surface is conductive; such touching can cause personal injury and machine damage.
- Do not service the following parts with the power on when they are removed from their normal operating places in a machine:
 - Power supply units
 - Pumps
 - Blowers and fans
 - Motor generatorsand similar units. (This practice ensures correct grounding of the units.)
- If an electrical accident occurs:
 - Caution: do not become a victim yourself.
 - Switch off the power.
 - Send the victim to get medical aid.

Safety inspection guide

The purpose of this inspection guide is to assist you in identifying potential unsafe conditions. As each machine was designed and built, required safety items were installed to protect users and service personnel from injury. This guide addresses only those items. You should use good judgment to identify potential safety hazards according to the attachment of non-Lenovo features or options not covered by this inspection guide.

If any unsafe conditions are present, you must determine how serious the apparent hazard could be and whether you can continue without first correcting the problem.

Consider these conditions and the safety hazards they present:

- Electrical hazards, especially primary power (primary voltage on the frame can cause serious or fatal electrical shock)
- Explosive hazards, such as a damaged CRT face or a bulging capacitor
- Mechanical hazards, such as loose or missing hardware

To determine whether there are any potential unsafe conditions, use the following checklist at the beginning of every service task. Begin the checks with the power off, and the power cord disconnected.

Checklist:

1. Check exterior covers for damage (loose, broken, or sharp edges).
2. Turn off the computer. Disconnect the power cord.
3. Check the power cord for:
 - a. A third-wire ground connector in good condition. Use a meter to measure third-wire ground continuity for 0.1 ohm or less between the external ground pin and the frame ground.
 - b. The power cord should be the type specified in the parts list.
 - c. Insulation must not be frayed or worn.
4. Check for cracked or bulging batteries.
5. Remove the cover.
6. Check for any obvious non-Lenovo alterations. Use good judgment as to the safety of any non-Lenovo alterations.
7. Check inside the unit for any obvious unsafe conditions, such as metal filings, contamination, water or other liquids, or signs of fire or smoke damage.
8. Check for worn, frayed, or pinched cables.
9. Check that the power-supply cover fasteners (screws or rivets) have not been removed or tampered with.

Handling devices that are sensitive to electrostatic discharge

Any computer part containing transistors or integrated circuits (ICs) should be considered sensitive to electrostatic discharge (ESD). ESD damage can occur when there is a difference in charge between objects. Protect against ESD damage by equalizing the charge so that the machine, the part, the work mat, and the person handling the part are all at the same charge.

Notes:

1. Use product-specific ESD procedures when they exceed the requirements noted here.
2. Make sure that the ESD protective devices you use have been certified (ISO 9000) as fully effective.

When handling ESD-sensitive parts:

- Keep the parts in protective packages until they are inserted into the product.
- Avoid contact with other people.
- Wear a grounded wrist strap against your skin to eliminate static on your body.
- Prevent the part from touching your clothing. Most clothing is insulative and retains a charge even when you are wearing a wrist strap.
- Use the black side of a grounded work mat to provide a static-free work surface. The mat is especially useful when handling ESD-sensitive devices.
- Select a grounding system, such as those listed below, to provide protection that meets the specific service requirement.

Note:

The use of a grounding system to guard against ESD damage is desirable but not necessary.

- Attach the ESD ground clip to any frame ground, ground braid, or green-wire ground.
- When working on a double-insulated or battery-operated system, use an ESD common ground or reference point. You can use coax or connector-outside shells on these systems.
- Use the round ground prong of the ac plug on ac-operated computers.

Grounding requirements

Electrical grounding of the computer is required for operator safety and correct system function. Proper grounding of the electrical outlet can be verified by a certified electrician.

Safety notices: multilingual translations

The safety notices in this section are provided in English, French, German, Hebrew, Italian, Japanese, and Spanish.

Safety notice 1

Before the computer is powered on after FRU replacement, make sure all screws, springs, and other small parts are in place and are not left loose inside the computer. Verify this by shaking the computer and listening for rattling sounds. Metallic parts or metal flakes can cause electrical shorts.

Avant de remettre l'ordinateur sous tension après remplacement d'une unité en clientèle, vérifiez que tous les ressorts, vis et autres pièces sont bien en place et bien fixées. Pour ce faire, secouez l'unité et assurez-vous qu'aucun bruit suspect ne se produit. Des pièces métalliques ou des copeaux de métal pourraient causer un court-circuit.

Bevor nach einem FRU-Austausch der Computer wieder angeschlossen wird, muß sichergestellt werden, daß keine Schrauben, Federn oder andere Kleinteile fehlen oder im Gehäuse vergessen wurden. Der Computer muß geschüttelt und auf Klappergeräusche geprüft werden. Metallteile oder-splitter können Kurzschlüsse erzeugen.

לפני הפעלת המחשב לאחר החלפת FRU יש לוודא שכל הברגים, הקפיצים, וחלקים קטנים אחרים נמצאים במקומם ואינם חופשיים לזוז בתוך המחשב. כדי לוודא זאת, יש ללטלט את המחשב ולהקשיב לגילוי קולות שקשוק. חלקי או שבבי מתכת עלולים לגרום לקצרים חשמליים.

Prima di accendere l'elaboratore dopo che é stata effettuata la sostituzione di una FRU, accertarsi che tutte le viti, le molle e tutte le altri parti di piccole dimensioni siano nella corretta posizione e non siano sparse all'interno dell'elaboratore. Verificare ciò scuotendo l'elaboratore e prestando attenzione ad eventuali rumori; eventuali parti o pezzetti metallici possono provocare cortocircuiti pericolosi.

FRUの交換後、コンピュータの電源を入れる前に、ねじ、バネ、その他の小さな部品がすべて正しい位置にあり、またコンピュータの内部で緩んでいないことを確認してください。これを確認するには、コンピュータを振って、カチャカチャと音がしないか確かめます。金属部品や金属破片はショートの原因になることがあります。

Antes de encender el sistema despues de sustituir una FRU, compruebe que todos los tornillos, muelles y demás piezas pequeñas se encuentran en su sitio y no se encuentran sueltas dentro del sistema. Compruébelo agitando el sistema y escuchando los posibles ruidos que provocarían. Las piezas metálicas pueden causar cortocircuitos eléctricos.

Safety notice 2

⚠ DANGER

Some standby batteries contain a small amount of nickel and cadmium. Do not disassemble a standby battery, recharge it, throw it into fire or water, or short-circuit it. Dispose of the battery as required by local ordinances or regulations. Use only the battery in the appropriate parts listing. Use of an incorrect battery can result in ignition or explosion of the battery.

Certaines batteries de secours contiennent du nickel et du cadmium. Ne les démontez pas, ne les rechargez pas, ne les exposez ni au feu ni à l'eau. Ne les mettez pas en court-circuit. Pour les mettre au rebut, conformez-vous à la réglementation en vigueur. Lorsque vous remplacez la pile de sauvegarde ou celle de l'horloge temps réel, veillez à n'utiliser que les modèles cités dans la liste de pièces détachées adéquate. Une batterie ou une pile inappropriée risque de prendre feu ou d'exploser.

Die Bereitschaftsbatterie, die sich unter dem Diskettenlaufwerk befindet, kann geringe Mengen Nickel und Cadmium enthalten. Sie darf nicht zerlegt, wiederaufgeladen, kurzgeschlossen, oder Feuer oder Wasser ausgesetzt werden. Bei der Entsorgung die örtlichen Bestimmungen für Sondermüll beachten. Beim Ersetzen der Bereitschafts- oder Systembatterie nur Batterien des Typs verwenden, der in der Ersatzteilliste aufgeführt ist. Der Einsatz falscher Batterien kann zu Entzündung oder Explosion führen.

סוללות המתנה מסוימות מכילות כמות קטנה של ניקל וקדמיום. אין לפרק סוללת המתנה, לטעון אותה מחדש, להשליך אותה לנאש או למים או לקצר אותה. יש לשלוק את הסוללה בנדרש על ידי התקנות והחוקים המקומיים. יש להשתמש רק בסוללה המתאימה בשימת החלקים המתאימה. שימוש בסוללה לא מתאימה עלול לגרום להצתה או התפוצצות של הסוללה.

Alcune batterie di riserva contengono una piccola quantità di nichel e cadmio. Non smontarle, ricaricarle, gettarle nel fuoco o nell'acqua né cortocircuitarle. Smaltirle secondo la normativa in vigore (DPR 915/82, successive disposizioni e disposizioni locali). Quando si sostituisce la batteria dell'RTC (real time clock) o la batteria di supporto, utilizzare soltanto i tipi inseriti nell'appropriato Catalogo parti. L'impiego di una batteria non adatta potrebbe determinare l'incendio o l'esplosione della batteria stessa.

予備バッテリーの中には少量のニッケルとカドミウムが含まれているものがあります。したがって、予備バッテリーの分解、再充電、火または水の中への投棄、またはショートさせることは決して行わないでください。バッテリーを廃棄する場合は地方自治体の条例に従ってください。適切なパーツ・リストにあるバッテリーだけを使用してください。誤ったバッテリーを使用すると、バッテリーが発火したり、爆発したりすることがあります。

Algunas baterías de reserva contienen una pequeña cantidad de níquel y cadmio. No las desmonte, ni recargue, ni las eche al fuego o al agua ni las cortocircuite. Deséchelas tal como dispone la normativa local. Utilice sólo baterías que se encuentren en la lista de piezas. La utilización de una batería no apropiada puede provocar la ignición o explosión de la misma.

Safety notice 3**⚠ DANGER**

The battery pack contains small amounts of nickel. Do not disassemble it, throw it into fire or water, or short-circuit it. Dispose of the battery pack as required by local ordinances or regulations. Use only the battery in the appropriate parts listing when replacing the battery pack. Use of an incorrect battery can result in ignition or explosion of the battery.

La batterie contient du nickel. Ne la démontez pas, ne l'exposez ni au feu ni à l'eau. Ne la mettez pas en court-circuit. Pour la mettre au rebut, conformez-vous à la réglementation en vigueur. Lorsque vous remplacez la batterie, veillez à n'utiliser que les modèles cités dans la liste de pièces détachées adéquate. En effet, une batterie inappropriée risque de prendre feu ou d'exploser.

Akkus enthalten geringe Mengen von Nickel. Sie dürfen nicht zerlegt, wiederaufgeladen, kurzgeschlossen, oder Feuer oder Wasser ausgesetzt werden. Bei der Entsorgung die örtlichen Bestimmungen für Sondermüll beachten. Beim Ersetzen der Batterie nur Batterien des Typs verwenden, der in der Ersatzteilliste aufgeführt ist. Der Einsatz falscher Batterien kann zu Entzündung oder Explosion führen.

מארו הסוללה מכיל כמויות קטנות של ניקל וקדמיום. אין לפרק את מארו הסוללה, להשליך אותו לאש או למים או לקצר אותו. יש לשלוק את מארו הסוללה כנדרש על ידי התקנות והחוקים המקומיים. יש להשתמש רק בסוללה המופיעה ברשימת החלקים המתאימה בזמן החלפת מארו הסוללה. שימוש בסוללה לא מתאימה עלול לגרום להצתה או התפוצצות של הסוללה.

La batteria contiene piccole quantità di nichel. Non smontarla, gettarla nel fuoco o nell'acqua né cortocircuitarla. Smaltirla secondo la normativa in vigore (DPR 915/82, successive disposizioni e disposizioni locali). Quando si sostituisce la batteria, utilizzare soltanto i tipi inseriti nell'appropriato Catalogo parti. L'impiego di una batteria non adatta potrebbe determinare l'incendio o l'esplosione della batteria stessa.

バッテリー・パックには少量のニッケルが含まれています。バッテリー・パックを分解したり、火または水の中に投げ込んだり、ショートさせないでください。バッテリー・パックの廃棄にあたっては、地方自治体の条例または規則に従ってください。バッテリー・パックを交換するときは、適切なパーツ・リストにあるバッテリーだけを使用してください。誤ったバッテリーを使用すると、バッテリーが発火したり、爆発したりすることがあります。

Las baterías contienen pequeñas cantidades de níquel. No las desmonte, ni recargue, ni las eche al fuego o al agua ni las cortocircuite. Deséchelas tal como dispone la normativa local. Utilice sólo baterías que se encuentren en la lista de piezas al sustituir la batería. La utilización de una batería no apropiada puede provocar la ignición o explosión de la misma.

Safety notice 4

⚠ DANGER

The lithium battery can cause a fire, an explosion, or a severe burn. Do not recharge it, remove its polarized connector, disassemble it, heat it above 100°C (212°F), incinerate it, or expose its cell contents to water. Dispose of the battery as required by local ordinances or regulations. Use only the battery in the appropriate parts listing. Use of an incorrect battery can result in ignition or explosion of the battery.

La pile de sauvegarde contient du lithium. Elle présente des risques d'incendie, d'explosion ou de brûlures graves. Ne la rechargez pas, ne retirez pas son connecteur polarisé et ne la démontez pas. Ne l'exposez pas à une température supérieure à 100°C, ne la faites pas brûler et n'en exposez pas le contenu à l'eau. Mettez la pile au rebut conformément à la réglementation en vigueur. Une pile inappropriée risque de prendre feu ou d'exploser.

Die Systematterie ist eine Lithiumatterie. Sie kann sich entzünden, explodieren oder schwere Verbrennungen hervorrufen. Batterien dieses Typs dürfen nicht aufgeladen, zerlegt, über 100 C erhitzt oder verbrannt werden. Auch darf ihr Inhalt nicht mit Wasser in Verbindung gebracht oder der zur richtigen Polung angebrachte Verbindungsstecker entfernt werden. Bei der Entsorgung die örtlichen Bestimmungen für Sondermüll beachten. Beim Ersetzen der Batterie nur Batterien des Typs verwenden, der in der Ersatzteilliste aufgeführt ist. Der Einsatz falscher Batterien kann zu Entzündung oder Explosion führen.

סוללת הליתיום עלולה לגרום לשריפה, להתפוצצות או לכוויות קשות. אין לטעון אותה מחדש, לטלוק את המחבר המקוטב שלה, לפרק אותה או לחמם אותה לטמפרטורה העולה על 100 מעלות צלזיוס. אין לשרוף את הסוללה ואין לחשוף את תוכן התא למים. יש לטלוק את הסוללה כנדרש בתקנות ובחוקים המקומיים. יש להשתמש רק בסוללה המומינה ברשימת החלקים המתאימים. שימוש בסוללה אחרת עלול לגרום לשכנת שריפה או התפוצצות.

La batteria di supporto e una batteria al litio e puo incendiarsi, esplodere o procurare gravi ustioni. Evitare di ricaricarla, smontarne il connettore polarizzato, smontarla, riscaldarla ad una temperatura superiore ai 100 gradi centigradi, incendiarla o gettarla in acqua. Smaltirla secondo la normativa in vigore (DPR 915/82, successive disposizioni e disposizioni locali). L'impiego di una batteria non adatta potrebbe determinare l'incendio o l'esplosione della batteria stessa.

リチウム・バッテリーは、火災、爆発、または重症のやけどを引き起こすことがあります。バックアップ・バッテリーの充電、その極性コネクタの取り外し、バッテリー本体の分解、100°C (212°F) 以上への加熱、焼却、電池の中身を水に浸すことはしないでください。バッテリーを廃棄する場合は地方自治体の条例に従ってください。適切なパーツ・リストにあるバッテリーだけを使用してください。誤ったバッテリーを使用すると、バッテリーが発火したり、爆発したりすることがあります。

La batería de repuesto es una batería de litio y puede provocar incendios, explosiones o quemaduras graves. No la recargue, ni quite el conector polarizado, ni la desmonte, ni caliente por encima de los 100°C (212°F), ni la incinere ni exponga el contenido de sus celdas al agua. Deséchela tal como dispone la normativa local.

Safety notice 5

If the LCD breaks and the fluid from inside the LCD gets into your eyes or on your hands, immediately wash the affected areas with water at least for 15 minutes. Seek medical care if any symptoms caused by the fluid are present after washing.

Si le panneau d'affichage à cristaux liquides se brise et que vous recevez dans les yeux ou sur les mains une partie du fluide, rincez-les abondamment pendant au moins quinze minutes. Consultez un médecin si des symptômes persistent après le lavage.

Die Leuchtstoffröhre im LCD-Bildschirm enthält Quecksilber. Bei der Entsorgung die örtlichen Bestimmungen für Sondermüll beachten. Der LCD-Bildschirm besteht aus Glas und kann zerbrechen, wenn er unsachgemäß behandelt wird oder der Computer auf den Boden fällt. Wenn der Bildschirm beschädigt ist und die darin befindliche Flüssigkeit in Kontakt mit Haut und Augen gerät, sollten die betroffenen Stellen mindestens 15 Minuten mit Wasser abgespült und bei Beschwerden anschließend ein Arzt aufgesucht werden.

אם מסך הנביש התוול (LCD) נשבר והתוול מתוך המסך בא במגע עם עיניים או ידיים, שטפו את האזורים הנגועים מיד במים במשך 15 דקות לפחות. פנו לקבלת עזרה רפואית אם תסמינים הנובעים מהמגע עם התוול נמשכים לאחר השטיפה.

Nel caso che caso l'LCD si dovesse rompere ed il liquido in esso contenuto entrasse in contatto con gli occhi o le mani, lavare immediatamente le parti interessate con acqua corrente per almeno 15 minuti; poi consultare un medico se i sintomi dovessero permanere.

LCD が破損し、LCD の中の液体が目に入ったり、手に触れたりした場合は、液体が触れた部分を少なくとも 15 分間洗い流してください。洗い流した後に、液体によって何らかの症状が現れた場合は、医師の治療を受けてください。

Si la LCD se rompe y el fluido de su interior entra en contacto con sus ojos o sus manos, lave inmediatamente las áreas afectadas con agua durante 15 minutos como mínimo. Obtenga atención medica si se presenta algún sintoma del fluido despues de lavarse.

Safety notice 6

⚠ DANGER

To avoid shock, do not remove the plastic cover that protects the lower part of the inverter card.

Afin d'éviter tout risque de choc électrique, ne retirez pas le cache en plastique protégeant la partie inférieure de la carte d'alimentation.

Aus Sicherheitsgründen die Kunststoffabdeckung, die den unteren Teil der Spannungswandlerplatine umgibt, nicht entfernen.

כדי למנוע התחשמלות, אין להסיר את מכסה הפלסטיק המגן על חלקו התחתון של הכרטיס התחנות.

Per evitare scosse elettriche, non rimuovere la copertura in plastica che avvolge la parte inferiore della scheda invertitore.

感電を防ぐため、インバーター・カードの下部を保護しているプラスチック・カバーを外さないでください。

Para evitar descargas, no quite la cubierta de plástico que rodea la parte baja de la tarjeta invertida.

Safety notice 7

⚠ DANGER

Though the main batteries have low voltage, a shorted or grounded battery can produce enough current to burn personnel or combustible materials.

Bien que le voltage des batteries principales soit peu élevé, le court-circuit ou la mise à la masse d'une batterie peut produire suffisamment de courant pour brûler des matériaux combustibles ou causer des brûlures corporelles graves.

Obwohl Hauptbatterien eine niedrige Spannung haben, können sie doch bei Kurzschluß oder Erdung genug Strom abgeben, um brennbare Materialien zu entzünden oder Verletzungen bei Personen hervorzurufen.

אף שהסוללות הראשיות הן בעלות מתח נמוך, סוללה מקוצרת או מוארקת עלולה להפיק זרם מספיק לגרימת כוויות או להצתת חומרים דליקים.

Sebbene le batterie di alimentazione siano a basso voltaggio, una batteria in corto circuito o a massa può fornire corrente sufficiente da bruciare materiali combustibili o provocare ustioni ai tecnici di manutenzione.

メイン・バッテリーの電圧は低くても、ショートしたり、接地したバッテリーが、作業者にやけどを負わせたり、可燃物を燃やすだけの電流を発生させる場合があります。

Aunque las baterías principales tienen un voltaje bajo, una batería cortocircuitada o con contacto a tierra puede producir la corriente suficiente como para quemar material combustible o provocar quemaduras en el personal.

Safety notice 8**⚠ DANGER**

Before removing any FRU, turn off the computer, unplug all power cords from electrical outlets, remove the battery pack, and then disconnect any interconnecting cables.

Avant de retirer une unité remplaçable en clientèle, mettez le système hors tension, débranchez tous les cordons d'alimentation des socles de prise de courant, retirez la batterie et déconnectez tous les cordons d'interface.

Die Stromzufuhr muß abgeschaltet, alle Stromkabel aus der Steckdose gezogen, der Akku entfernt und alle Verbindungskabel abgenommen sein, bevor eine FRU entfernt wird.

לפני סילוק FRU כלשהו, יש לכבות את המחשב, לנתק את כל כבלי החשמל משקעי החשמל, להוציא את מטריז הסוללה, ואז לנתק כבלי חיבור אחרים אם יש כאלה.

Prima di rimuovere qualsiasi FRU, spegnere il sistema, scollegare dalle prese elettriche tutti i cavi di alimentazione, rimuovere la batteria e poi scollegare i cavi di interconnessione.

FRU を取り外す前に、**ThinkPad** の電源を切って、すべての電源コードをコンセントから外してください。次に、バッテリー・パックを外し、相互接続ケーブルを外してください。

Antes de quitar una FRU, apague el sistema, desenchufe todos los cables de las tomas de corriente eléctrica, quite la batería y, a continuación, desconecte cualquier cable de conexión entre dispositivos.

Laser compliance statement

Some models of Lenovo computer are equipped from the factory with an optical storage device such as a CD-ROM drive or a DVD-ROM drive. Such devices are also sold separately as options. If one of these drives is installed, it is certified in the U.S. to conform to the requirements of the Department of Health and Human Services 21 Code of Federal Regulations (DHHS 21 CFR) Subchapter J for Class 1 laser products. Elsewhere, the drive is certified to conform to the requirements of the International Electrotechnical Commission (IEC) 825 and CENELEC EN 60 825 for Class 1 laser products.

If a CD-ROM drive, a DVD-ROM drive, or another laser device is installed, note the following:

CAUTION

Use of controls or adjustments or performance of procedures other than those specified herein might result in hazardous radiation exposure.

O uso de controles, ajustes ou desempenho de procedimentos diferentes daqueles aqui especificados pode resultar em perigosa exposição à radiação.

凡未在这里指明的任何控制用法、调整、行为，都会导致严重后果。

Pour éviter tout risque d'exposition au rayon laser, respectez les consignes de réglage et d'utilisation des commandes, ainsi que les procédures décrites.

Werden Steuer- und Einstellelemente anders als hier festgesetzt verwendet, kann gefährliche Laserstrahlung auftreten.

Az itt előírt eljárásoktól, beállítástól és vezérlésektől eltérni a lézersugárzás veszélye miatt kockázatos!

L'utilizzo di controlli, regolazioni o l'esecuzione di procedure diverse da quelle specificate possono provocare l'esposizione a.

Использование элементов настройки и выполнение процедур иных, чем указано здесь, может привести к опасному радиационному облучению.

Použitie kontrol, úprav alebo iných vykonaní od iných výrobcov, ako je v tomto špecifikované, mohlo by mať za následok nebezpečenstvo vystavenia sa vyžiarovaniu.

本書で指定された内容以外の、お客様による整備、調整、または手順を行った場合、レーザー光の放射の危険があります。

El uso de controles o ajustes o la ejecución de procedimientos distintos de los aquí especificados puede provocar la exposición a radiaciones peligrosas.

Opening the CD-ROM drive, the DVD-ROM drive, or any other optical storage device could result in exposure to hazardous laser radiation. There are no serviceable parts inside those drives. **Do not open.**

A CD-ROM drive, a DVD-ROM drive, or any other storage device installed may contain an embedded Class 3A or Class 3B laser diode. Note the following:

 **DANGER**

Emits visible and invisible laser radiation when open. Do not stare into the beam, do not view directly with optical instruments, and avoid direct exposure to the beam.

Radiação por raio laser ao abrir. Não olhe fixo no feixe de luz, não olhe diretamente por meio de instrumentos óticos e evite exposição direta com o feixe de luz.

开启时会有激光发射时，请勿直视激光束，请勿直接查看视觉仪器，并且避免直接接触在激光光束之中。

Rayonnement laser si carter ouvert. Évitez de fixer le faisceau, de le regarder directement avec des instruments optiques, ou de vous exposer au rayon.

Laserstrahlung bei geöffnetem Gerät. Nicht direkt oder über optische Instrumente in den Laserstrahl sehen und den Strahlungsbereich meiden.

Kinyitáskor lézersugár ! Ne nézzen bele se szabad szemmel, se optikai eszközökkel. Kerülje a sugárnyalábbal való érintkezést!

Apriendo l'unità vengono emesse radiazioni laser. Non fissare il fascio, non guardarlo direttamente con strumenti ottici e evitare l'esposizione diretta al fascio.

Открывая, берегитесь лазерного излучения. Не смотрите на луч, не разглядывайте его с помощью оптических инструментов, а также избегайте прямого воздействия лазерного луча.

Keď je laserová jednotka otvorená. Vyhnite sa priamemu pohľadu a nehladte priamo s optickými nástrojmi do lúča a vyhnite sa priamemu vystaveniu lúčov.

開けるとレーザー光が放射されます。光線を見つめたり、光学機械を使って直接見たりしないでください。

Radiación láser al abrir. No mire fijamente ni examine con instrumental óptico el haz de luz. Evite la exposición directa al haz.

Important service information

This chapter presents the following important service information:

- “Strategy for replacing FRUs” on page 16
 - “Strategy for replacing a hard disk drive” on page 17
 - “Important notice for replacing a system board” on page 17
- “Important information about replacing RoHS compliant FRUs” on page 18

Important:

BIOS and device driver fixes are customer-installable. The BIOS and device drivers are posted on the customer support site:

<http://support.lenovo.com>.

Strategy for replacing FRUs

Before replacing parts:

Make sure that all software fixes, drivers, and BIOS downloads are installed before replacing any FRUs listed in this manual.

After a system board is replaced, ensure that the latest BIOS is loaded to the system board before completing the service action.

To download software fixes, drivers, and BIOS, follow the steps below:

1. Go to <http://support.lenovo.com>.
2. Enter the serial number or select a product or use Lenovo smart downloading.
3. Select the BIOS/Driver/Applications and download.
4. Follow the directions on the screen and install the necessary software.

Use the following strategy to prevent unnecessary expense for replacing and servicing FRUs:

- If you are instructed to replace an FRU, but the replacement does not solve the problem, reinstall the original FRU before you continue.
- Some computers have both a processor board and a system board. If you are instructed to replace either of them, and replacing one of them does not solve the problem, reinstall that board, and then replace the other one.
- If an adapter or a device consists of more than one FRU, any of the FRUs may be the cause of the error. Before replacing the adapter or device, remove the FRUs one by one to see if the symptoms change. Replace only the FRU that changed the symptoms.

Attention: The setup configuration on the computer you are servicing may have been customized. Running Automatic Configuration may alter the settings. Note the current configuration settings (using the View Configuration option); then, when service has been completed, verify that those settings remain in effect.

Strategy for replacing a hard disk drive

Always try to run a low-level format before replacing a hard disk drive. This will cause all customer data on the hard disk to be lost. Make sure that the customer has a current backup of the data before performing this action.

Attention: The drive startup sequence in the computer you are servicing may have been changed. Be extremely careful during write operations such as copying, saving, or formatting. If you select an incorrect drive, data or programs can be overwritten.

Important notice for replacing a system board

Some components mounted on a system board are very sensitive. Improper handling can cause damage to those components, and may cause a system malfunction.

Attention: When handling a system board:

- Do not drop the system board or apply any excessive force to it.
- Avoid rough handling of any kind.
- Avoid bending the system board and hard pushing to prevent cracking at each BGA (Ball Grid Array) chipset.

Important information about replacing RoHS compliant FRUs

RoHS, The Restriction of Hazardous Substances in Electrical and Electronic Equipment Directive (2002/95/EC) is a European Union legal requirement affecting the global electronics industry. RoHS requirements must be implemented on Lenovo products placed on the market after June 2006. Products on the market before June 2006 are not required to have RoHS compliant parts. If the original FRU parts are non-compliant, replacement parts can also be non-compliant. In all cases if the original FRU parts are RoHS compliant, the replacement part must also be RoHS compliant.

Note: RoHS and non-RoHS FRU part numbers with the same fit and function are identified with unique FRU part numbers.

Lenovo plans to transit to RoHS compliance well before the implementation date and expects its suppliers to be ready to support Lenovo's requirements and schedule in the EU. Products sold in 2005 and 2006 will contain some RoHS compliant FRUs. The following statement pertains to these products and any product Lenovo produces containing RoHS compliant FRUs.

RoHS compliant FRUs have unique FRU part numbers. Before or after the RoHS implementation date, failed RoHS compliant parts must always be replaced with RoHS compliant ones, so only the FRUs identified as compliant in the system HMM or direct substitutions for those FRUs may be used.

Products marketed before June 2006		Products marketed after June 2006	
Current or original part	Replacement FRU	Current or original part	Replacement FRU
Non-RoHS	Can be Non-RoHS	Must be RoHS	Must be RoHS
Non-RoHS	Can be RoHS		
Non-RoHS	Can sub to RoHS		
RoHS	Must be RoHS		

Note: A direct substitution is a part with a different FRU part number that is automatically shipped by the distribution center at the time of the order.

General checkout

This chapter presents the following information:

- “What to do first” on page 20
- “Power system checkout” on page 21

Before you go to the checkout, make sure to read the following important notes:

Important notes:

- **Only certified trained personnel can service the computer.**
- **Before replacing any FRU, read the entire page on removing and replacing FRUs.**
- **Carefully remove screws for reuse when replacing FRUs.**
- **Be extremely careful during such write operations as copying, saving, or formatting.** Drives in the computer that you are servicing sequence might have been altered. If you select an incorrect drive, data or programs might be overwritten.
- **Replace an FRU only with another FRU of the correct model.** When you replace an FRU, make sure that the machine model and the FRU part number are correct by referring to the FRU parts list.
- **An FRU should not be replaced just because of a single, unreproducible failure.** Single failures can occur for a variety of reasons that have nothing to do with a hardware defect, such as cosmic radiation, electrostatic discharge, or software errors. Consider replacing an FRU only when a problem recurs. If you suspect that an FRU is defective, clear the error logs and run the test again. If the error does not recur, do not replace the FRU.
- **Be careful not to replace a nondefective FRU.**

What to do first

When you do return an FRU, you must include the following information in the parts exchange form or parts return form that you attach to it:

1. Name and phone number of servicer
2. Date of service
3. Date on which the machine failed
4. Date of purchase
5. Procedure index and page number in which the failing FRU was detected
6. Failing FRU name and part number
7. Machine type, model number, and serial number
8. Customer's name and address

Note for warranty: During the warranty period, the customer may be responsible for repair costs if the computer damage was caused by misuse, accident, modification, unsuitable physical or operating environment, or improper maintenance by the customer.

The following is a list of some common items that are not covered under warranty and some symptoms that might indicate that the system was subjected to stress beyond normal use.

Before checking problems with the computer, determine whether the damage is covered under the warranty by referring to the following list:

The following are not covered under warranty:

- LCD panel cracked from the application of excessive force or from being dropped
- Scratched (cosmetic) parts
- Distortion, deformation, or discoloration of the cosmetic parts
- Plastic parts, latches, pins, or connectors that have been cracked or broken by excessive force
- Damage caused by liquid spilled into the system
- Damage caused by the improper insertion of a PC Card or the installation of an incompatible card
- Improper disk insertion or use of an optical drive
- Diskette drive damage caused by pressure on the diskette drive cover, foreign material in the drive, or the insertion of a diskette with multiple labels
- Damaged or bent diskette eject button
- Fuses blown by attachment of a nonsupported device
- Forgotten computer password (making the computer unusable)
- Sticky keys caused by spilling a liquid onto the keyboard
- Use of an incorrect AC adapter on laptop products

The following symptoms might indicate damage caused by nonwarranted activities:

- Missing parts might be a symptom of unauthorized service or modification.
- If the spindle of a hard disk drive becomes noisy, it may have been subjected to excessive force, or dropped.

Power system checkout

To verify a symptom, follow the steps below:

1. Turn off the computer.
2. Remove the battery pack.
3. Connect the AC adapter.
4. Make sure that power is supplied when you turn on the computer.
5. Turn off the computer.
6. Disconnect the AC adapter and install the charged battery pack.
7. Make sure that the battery pack supplies power when you turn on the computer.

If you suspect a power problem, see the appropriate one of the following power supply checkouts:

- “Checking the AC adapter” on page 21
- “Checking operational charging” on page 22
- “Checking the battery pack” on page 22

Checking the AC adapter

You are here because the computer fails only when the AC adapter is used.

- If the power-on indicator does not turn on, check the power cord of the AC adapter for correct continuity and installation.
- If the computer does not charge during operation, go to “Checking operational charging”.

To check the AC adapter, follow the steps below:

1. Unplug the AC adapter cable from the computer.
2. Measure the output voltage at the plug of the AC adapter cable. See the following figure:



Pin	Voltage (V DC)
1	+20
2	0

Note: Output voltage for the AC adapter pin No. 2 may differ from the one you are servicing.

3. If the voltage is not correct, replace the AC adapter.
4. If the voltage is acceptable, do the following:
 - Replace the system board.
 - If the problem persists, go to “Lenovo V330-15ISK/Lenovo V330-15IKB/Lenovo V130-15IGM/Lenovo V130-15IKB” on page 26.

Note: Noise from the AC adapter does not always indicate a defect.

Checking operational charging

To check whether the battery charges properly during operation, use a discharged battery pack or a battery pack that has less than 50% of the total power remaining when installed in the computer.

Perform operational charging. If the battery status indicator or icon does not light on, remove the battery pack and let it return to room temperature. Reinstall the battery pack. If the charge indicator or icon is still off, replace the battery pack.

If the charge indicator still does not light on, replace the system board. Then reinstall the battery pack. If it is still not charged, go to the next section.

Checking the battery pack

Battery charging does not start until the Power Meter shows that less than 95% of the total power remains; under this condition the battery pack can charge to 100% of its capacity. This protects the battery pack from being overcharged or from having a shortened life.

To check your battery, move your cursor to the Power Meter icon in the icon tray of the Windows® taskbar and wait for a moment (but do not click it), and the percentage of battery power remaining is displayed. To get detailed information about the battery, double-click the Power Meter icon.

Note: If the battery pack becomes hot, it may not be able to be charged. Remove it from the computer and leave it at room temperature for a while. After it cools down, reinstall and recharge it.

Related service information

This chapter presents the following information:

- “Restoring the factory contents by using Recovery system” on page 23
- “Passwords” on page 24
- “Power management” on page 25

Restoring the factory contents by using Recovery system

Restore of factory default

The Lenovo V330-15ISK/Lenovo V330-15IKB/Lenovo V130-15IGM/Lenovo V130-15IKB computers come with pre-installed Recovery System. In order to save application files and the initial backed up files of the system, the hard disk in a Lenovo computer includes a hidden partition when it is shipped. If you need to restore the system to the point of your first boot up, just enter the recovery system. For details of recovery system, see *the User Guide for Recovery system*.

Note: This will delete all the new data on the system partition (C drive), which is not recoverable. Make sure to back up your critical data before you perform this action.

Passwords

As many as three passwords may be needed for any Lenovo computer: the power-on password (POP), the hard disk password (HDP), and the administrator password.

If any of these passwords has been set, a prompt for it appears on the screen whenever the computer is turned on. The computer does not start until the password is entered.

Power-on password

A power-on password (POP) protects the system from being powered on by an unauthorized person. The password must be entered before an operating system can be booted.

Hard-disk password

There are two hard-disk passwords (HDPs):

+ User HDP - for the user

+ Master HDP - for the system administrator, who can use it to get access to the hard disk drive even if the user has changed the user HDP

Attention: If the user HDP has been forgotten, check whether a master HDP has been set. If it has, it can be used for access to the hard disk drive. If no master HDP is available, neither Lenovo nor Lenovo authorized service technicians provide any services to reset either the user or the master HDP, or to recover data from the hard disk drive. The hard disk drive can be replaced for a scheduled fee.

Administrator password

Administrator password controls the access of the whole setup utility. Only Administrator password was set then User password can be set. If Administrator password was cleared, the User password was cleared too.

Power management

Note: Power management modes are not supported for APM operating system. When you have finished working with your computer, you can set it to shut down, sleep or hibernate.

Putting the computer to sleep or shutting it down

When you have finished working with your computer, you can put it to sleep or shut it down.

Putting your computer to sleep

If you will be away from your computer for only a short time, put the computer to sleep. When the computer is in sleep mode, you can quickly wake it to resume use, bypassing the startup process.

To put the computer to sleep, do one of the following:

- Close the display lid.
- Press the Power button.
- Do the proper operations in the operating system.

Windows 7:

Click **Start**  → **Sleep**.

Windows 10:

Open the start menu, and then select **Power**  → **Sleep**.

Attention: Wait until the power button indicator light starts blinking (indicating that the computer is in sleep mode) before you move your computer. Moving your computer while the hard disk is spinning can damage the hard disk, causing loss of data.

To wake the computer, do one of the following:

- Press any key on the keyboard.
- Press the Power button.

Shutting down the computer


If you are not going to use your computer for a long time, shut it down.

To shut down the computer, do one of the following:

• **Windows 7:**

Click **Start**  → **Shut down**

• **Windows 10:**

- Open the start menu, and then select **Power**  → **Shut down**.
- Right-click the **Start** button in the lower-left corner and select **Shut down or sign out** → **Shut down**.

Lenovo V330-15ISK/Lenovo V330-15IKB/ Lenovo V130-15IGM/Lenovo V130-15IKB

This chapter presents the following product-specific service references and product-specific parts information:

- “Specifications” on page 26
- “Status indicators” on page 28
- “Fn key combinations/Hotkeys” on page 30
- “FRU replacement notices” on page 31
- “Removing and replacing an FRU” on page 32
- “Locations” on page 69
- “Parts list” on page 71

Specifications

The following table lists the specifications of the Lenovo V330-15ISK/
 Lenovo V330-15IKB/Lenovo V130-15IGM/Lenovo V130-15IKB:

Table 1. Specifications

Feature	Description
Processor	See the system properties of your computer. You can do this as follows: <ul style="list-style-type: none"> • Windows 10: Click Start, right-click File Explorer, and then click Properties. • Windows 7: Click Start, right-click Computer; then from the pull down menu select Properties.
Bus architecture	<ul style="list-style-type: none"> • DDR4 2400 MHz --- On board + SO-DIMM • PCIE --- LAN, WLAN, SSD • SATA --- HDD, ODD, SSD • USB --- Full function Type-C x 1, Normal Type-C x 1, USB3.0 x 2 • LPC --- TPM/TCM • HDA--- Audio codec • EDP --- FHD/HD panel • DDI --- HDMI, Type-C • PEG --- AMD graphic
Graphic memory chip	<ul style="list-style-type: none"> • Integrated Graphics: Depends on CPU • Discrete Graphics: Switchable with Integrated graphics, Level 2 graphics (25W)/Switchable with Integrated graphics, AMD R17M-M1-70, Level 2 graphics (18W turbo to 25W) (Design Reserve)
Display	<ul style="list-style-type: none"> • 15.6" 16:9, 1,366 × 768 pixels HD / 1,920 × 1,080 pixels FHD
Standard memory	<ul style="list-style-type: none"> • DDR4-2133 MHz / 2400 MHz (max: 4 GB (on board) + 16 GB)
CMOS RAM	<ul style="list-style-type: none"> • SPI --- SPI ROM
Storage devices	<ul style="list-style-type: none"> • HDD: 2.5-inch, 7 mm, SATA 3 (SATA 2 compatible), 500 GB / 1 TB / 2 TB • SSD: M.2/SATA 2.5-inch 128 GB / 256 GB / 512 GB

Table 1. Specifications (continued)

Feature	Description
Optical drive (on select models)	<ul style="list-style-type: none"> 9.0 mm, Writer
I/O port	<ul style="list-style-type: none"> USB 3.0 (AOU) × 1, USB 3.0 × 1 Type-C × 1 (compatible with USB 3.1) (on select models) Type-C × 1 (compatible with USB 3.1, DisplayPort, PowerDelivery & Docking) (on select models) Combo audio jack × 1 VGA × 1 HDMI port × 1 RJ-45 × 1 (1000 Mbps) Memory card slot (SD/SDHC/SDXC/MMC)
Audio	<ul style="list-style-type: none"> 1/8" Combo audio jack 2 W speaker × 2 2 W speaker × 1 (on select models) Digital microphone, combo with camera (on select models)
Ethernet	<ul style="list-style-type: none"> 1000 Mbps
Bluetooth wireless	<ul style="list-style-type: none"> Combined in combo card
Keyboard	<ul style="list-style-type: none"> 6 rows Lenovo Keyboard
Touchpad	<ul style="list-style-type: none"> Multi-touch touchpad
Fingerprint Reader	<ul style="list-style-type: none"> Optional
Integrated camera	<ul style="list-style-type: none"> 720p / 0.3 M (on select models)
Battery	<ul style="list-style-type: none"> Li-ion battery pack Base battery: 2 Cells, 30 Wh / 39 Wh Removable battery (on select models): 2 Cells, 39 Wh
AC adapter	<ul style="list-style-type: none"> 20 V, DIS 65 W, UMA 45 W
Pre-installed operating system	<ul style="list-style-type: none"> DOS Win7 Pro 32bit (for PRC and Skylake based models only) Win7 Pro 64bit (for PRC and Skylake based models only) Win7 Home Basic 64bit (for PRC and Skylake based models only) Win10 Home 64bit/Win10 Pro 64bit Win10 2017&2018 refresh Win10 Pro 64bit Downgrade to Win7 Pro 64bit (for Skylake based models only) Win10 Pro 64bit Downgrade to Win7 Pro 32bit (for Skylake based models only) - design reserve Ubuntu Linux

Status indicators

The system status indicators below show the computer status:



Table 2. Status indicators



Indicator	AC power adapter status	Indicator status	Meaning
1  Battery status indicator	Disconnected	Off	The computer is in sleep mode or turned off; The battery has more than 20% charge.
		Solid amber	The battery has between 5% and 20% charge.
		Fast blinking amber	The battery has between 1% and 5% charge.
	Connected	Slow blinking amber	The battery is being charged. When battery charge reaches 20%, the blinking color changes to white.
		Slow blinking white	The battery has between 20% and 80% charge and is still charging. When the battery reaches 80% charge the light will stop blinking.
		Solid white	The battery has more than 80% charge, charging will continue until the battery is fully charged.
2  Hard disk drive	---	Blinking	The hard disk drive is reading or writing data.

Table 2. Status indicators (continued)

Indicator	AC power adapter status	Indicator status	Meaning
<div style="text-align: center; margin-bottom: 5px;">3</div> Power status indicator	Disconnected	Off	Disconnect the AC power adapter from the computer.
	Connected	On (solid white)	Connect the AC power adapter (plugged into a working electrical outlet) to the computer.

Fn key combinations/Hotkeys













The following table shows the function of each combination of Fn with a function key.

Table 3. Fn key combinations

Fn + B:	Activates the break function.
Fn + P:	Activates the pause function.
Fn + C:	Enables/disables the scroll lock.
Fn + S:	Activates the system request.
Fn + ↑:	Activates the PgUp key function.
Fn + ↓:	Activates the PgDn key function.
Fn + ←:	Activates the home key function.
Fn + →:	Activates the end key function.
Fn + Space (on select models):	Adjusts the keyboard backlight (off → dim → bright → off).

You can access certain system settings quickly by pressing the appropriate hotkeys.

Table 4. Hotkeys

 : Mutes/unmutes the sound.	 : Enables/disables Airplane mode.
 : Decreases the volume level.	 : Enables/disables the integrated camera (on select models).
 : Increases the volume level.	 : Locks the screen.
 : Enables/disables the microphone (on select models).	 : Toggles the display between the computer and an external device.
 : Refreshes the desktop or the currently active window.	 : Decreases the display brightness.
 : Enables/disables the touchpad.	 : Increases the display brightness.

FRU replacement notices

This section presents notices related to removing and replacing parts. Read this section carefully before replacing any FRU.

Screw notices

Loose screws can cause a reliability problem. In the Lenovo computer, this problem is addressed with special nylon-coated screws that have the following characteristics:

- They maintain tight connections.
- They do not easily come loose, even with shock or vibration.
- They are harder to tighten.

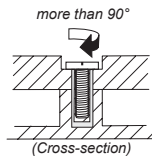
Do the following when you service this machine:

- Keep the screw kit in your tool bag.
- Carefully remove screws for reuse when replacing FRUs.
- Use a torque screwdriver if you have one.

Tighten screws as follows:

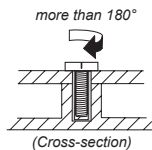
- **Plastic to plastic**

Turn an additional 90° after the screw head touches the surface of the plastic part:



- **Logic card to plastic**

Turn an additional 180° after the screw head touches the surface of the logic card:



- **Torque driver**

If you have a torque screwdriver, refer to the "Torque" column for each step.

- Make sure that you use the correct screws. If you have a torque screwdriver, tighten all screws firmly to the torque shown in the table. **Carefully remove screws for reuse when replacing FRUs. Make sure that all screws are tightened firmly.**
- Ensure torque screwdrivers are calibrated correctly following country specifications.

Removing and replacing an FRU

This section presents exploded figures with the instructions to indicate how to remove and replace the FRU. Make sure to observe the following general rules:

1. Do not attempt to service any computer unless you have been trained and certified. An untrained person runs the risk of damaging parts.
2. Before replacing any FRU, review "FRU replacement notices" on page 31.
3. Begin by removing any FRUs that have to be removed before the failing FRU. Any of such FRUs are listed at the top of the page. Remove them in the order in which they are listed.
4. Follow the correct sequence in the steps to remove the FRU, as given in the figures by the numbers in square callouts.
5. When turning a screw to replace an FRU, turn it in the direction as given by the arrow in the figure.
6. When removing the FRU, move it in the direction as given by the arrow in the figure.
7. To put the new FRU in place, reverse the removal procedures and follow any of the notes that pertain to replacement. For information about connecting and arranging internal cables, see "Locations" on page 69.
8. When replacing an FRU, use the correct screw as shown in the procedures.

DANGER

Before removing any FRU, turn off the computer, unplug all power cords from electrical outlets, remove the battery pack, and then disconnect any of the interconnecting cables.

Attention: After replacing an FRU, do not turn on the computer until you have made sure that all screws, springs, and other small parts are in place and none are loose inside the computer. Verify this by shaking the computer gently and listening for rattling sounds. Metallic parts or metal flakes can cause electrical short circuits.

Attention: The system board is sensitive to, and can be damaged by, electrostatic discharge. Before touching it, establish personal grounding by touching a ground point with one hand or using an electrostatic discharge (ESD) strap (P/N 6405959) to remove potential shock reasons.

Notes:

- This manual applies to the following models: Lenovo V330-15ISK/
Lenovo V330-15IKB/Lenovo V130-15IGM/Lenovo V130-15IKB.
- The illustrations used in this manual are for Lenovo V330-15IKB unless otherwise stated.

1010 Removable module (on select models)

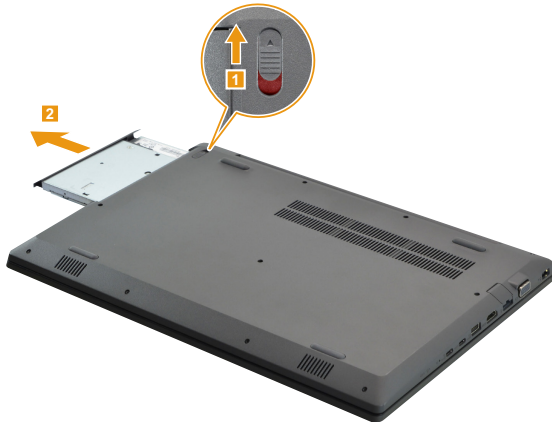
Attention:

To protect your HDD, please do not swap between ODD and 2nd battery when system is running.

Figure 1. Removal steps of removable module (on select models)

Note: Some models are supplied with an optical disk drive, a removable battery, or a dummy case as an optional module. For example purposes, this section describes the replacement of the optical disk drive module.

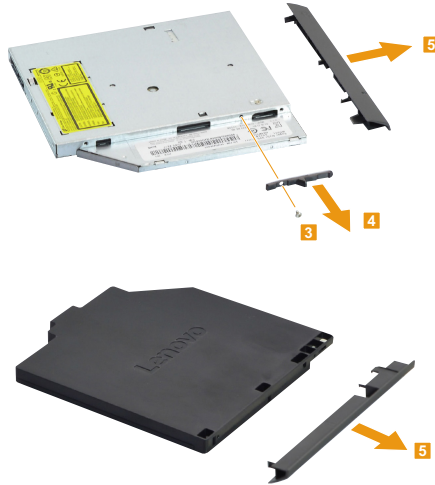
Hold the spring-loaded latch in the unlocked position **1**. Gently pull the removable module out **2**.



// Lenovo V330-15ISK/Lenovo V330-15IKB/Lenovo V130-15IGM/ Lenovo V130-15IKB Hardware Maintenance Manual

Figure 1. Removal steps of removable module (on select models) (continued)

Remove the screw **3**, then carefully remove the removable module latch catch and bezel in the directions shown by arrows **4** and **5**.



Step	Screw (quantity)	Color	Torque
3	M2 × 2.5 mm, Phillips head, nylok-coated (1) ODD Hook → ODD	Silver	1.85±0.15 kg*cm

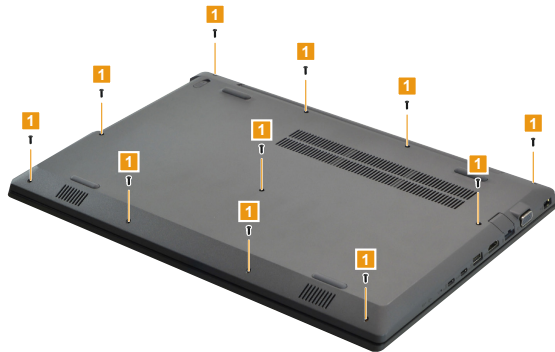
1020 Base cover

For access, remove this FRU:

- “1010 Removable module (on select models)” on page 33

Figure 2. Removal steps of base cover

Remove the screws **1** from the bottom.

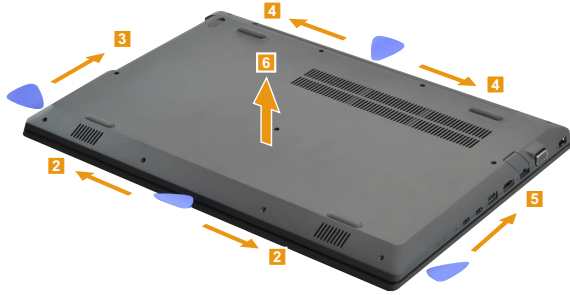


Step	Screw (quantity)	Color	Torque
1	M2 × 6.0 mm, Phillips head, nylok-coated (11) D cover → C cover	Black	1.85±0.15 kgf*cm

// Lenovo V330-15ISK/Lenovo V330-15IKB/Lenovo V130-15IGM/ Lenovo V130-15IKB Hardware Maintenance Manual

Figure 2. Removal steps of base cover (continued)

Use a plastic prying tool to aid in separation shown by arrows **2**, **3**, **4**, and **5**. Then remove the base cover in the direction shown by arrow **6**.



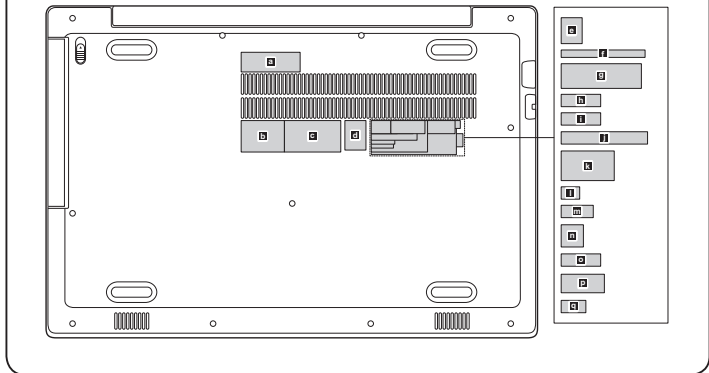
Note: Applying labels to the base cover

If you see the following labels on base cover, it needs to be peeled off from the old base cover, and put on the new base cover.

- | | | | |
|----------|-------------------------|----------|----------------------------|
| a | COA label | j | Warning label for TW |
| b | Rating label-1 | k | KCC label |
| c | Rating label-2 | l | Postel label for Indonesia |
| d | GML label | m | D Side label for Indonesia |
| e | Office label | n | BIS label for India |
| f | CNC label for Argentina | o | WL/BT label for Israel |
| g | Argentina label | p | WL/BT label for Brazil |
| h | WL label for US/CA/TW | q | WL label for South Africa |
| i | BT label for US/CA/TW | | |

For some models, you also need to apply one or two FCC labels. Check the old base cover; if it has one or two FCC labels, find duplicates of them in the label kit and apply them to the new base cover.

For the location of each label, refer to the following figures:



1030 Battery pack

For access, remove these FRUs in order:

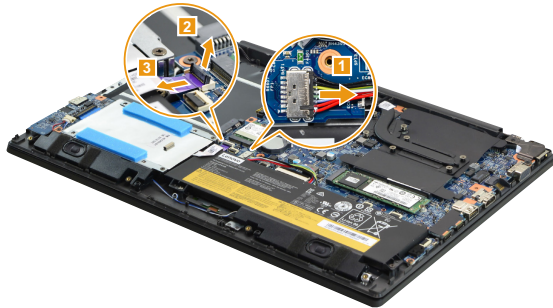
- “1010 Removable module (on select models)” on page 33
- “1020 Base cover” on page 35

⚠ DANGER

Only use the battery specified in the parts list for your computer. Any other battery could ignite or explode.

Figure 3. Removal steps of battery pack

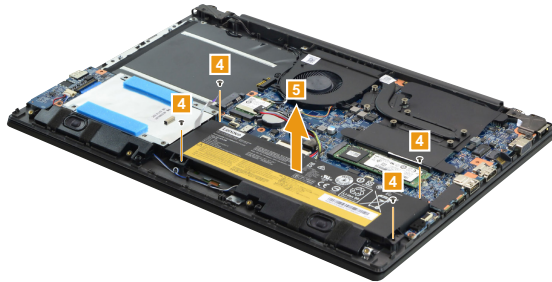
Unplug the battery pack connector in the direction shown by arrow **1**. Detach the HDD cable connector in the direction shown by arrows **2** and **3**, then carefully turn the HDD cable over.



When installing: Make sure that the connectors are attached firmly.

Figure 3. Removal steps of battery pack (continued)

Remove the screws **4**. Remove the battery pack in the direction shown by arrow **5**.



Step	Screw (quantity)	Color	Torque
4	M2 × 3.0 mm, Phillips head, nylok-coated (4) Battery → C cover	Black	1.85±0.15 kgf*cm

1040 Hard disk drive

For access, remove these FRUs in order:

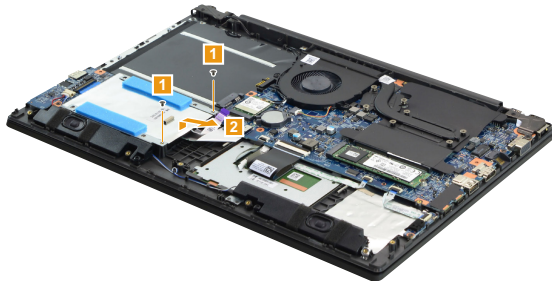
- “1010 Removable module (on select models)” on page 33
- “1020 Base cover” on page 35
- “1030 Battery pack” on page 38

Attention:

- **Do not drop the hard disk drive or apply any physical shock to it.** The hard disk drive is sensitive to physical shock. Improper handling can cause damage and permanent loss of data.
- Before removing the drive, suggest the customer to backup all the information on it if possible.
- Never remove the drive while the system is operating or is in suspend mode.

Figure 4. Removal steps of hard disk drive

Remove the screws **1**, then lift the hard disk drive in the direction shown by arrow **2**.



Step	Screw (quantity)	Color	Torque
1	M3 × 4.0 mm, Phillips head, nylok-coated (2) HDD ASSY → C cover	Silver	1.85±0.15 kgf*cm

Figure 4. Removal steps of hard disk drive (continued)

Remove the screws **3**. Remove the HDD cable **4**, then take out the metal frame.



Step	Screw (quantity)	Color	Torque
3	M2 × 3.0 mm, Phillips head, nylok-coated (4) HDD bracket → HDD	Black	1.85±0.15 kgf*cm

1050 Solid state disk

For access, remove these FRUs in order:

- “1010 Removable module (on select models)” on page 33
- “1020 Base cover” on page 35
- “1030 Battery pack” on page 38

Figure 5. Removal steps of solid state disk

Remove the screw **1**.



Step	Screw (quantity)	Color	Torque
1	M2 × 3.0 mm, Phillips head, nylok-coated (1) SSD → C cover	Black	1.85±0.15 kg*cm

Remove the solid state disk in the direction shown by arrow **2**.



1060 PCI Express Mini Card for wireless LAN

For access, remove these FRUs in order:

- “1010 Removable module (on select models)” on page 33
- “1020 Base cover” on page 35
- “1030 Battery pack” on page 38

Important: The preinstalled WLAN module may only be replaced with a Lenovo approved module in order to comply with FCC and IC regulations. Refer to “Table 5. Parts list—Overall” on page 73 for Lenovo part numbers for the approved modules.

Figure 6. Removal steps of PCI Express Mini Card for wireless LAN

Disconnect the two wireless LAN cables (black, white) **1**, and then remove the screw **2**.



In step **1**, unplug the jacks by using the removal tool antenna RF connector (P/N: 08K7159), or pick up the connectors with your fingers and gently unplug them in the direction shown by the arrows.

Notes: The wireless LAN card has 2 cables in step **1**.
The wireless LAN card in some models might have 3 cables in step **1**.

Step	Screw (quantity)	Color	Torque
2	M2 × 3.0 mm, Phillips head, nylok-coated (1) Mini PCI → C cover	Black	1.85±0.15 kgf*cm

Figure 6. Removal steps of PCI Express Mini Card for wireless LAN (continued)

Remove the card in the direction shown by arrow **3**.



When installing:

- In models with a wireless LAN card that has two antenna connectors, plug the black cable (1st) (MAIN) into the jack labeled **MAIN**, and the white cable (2nd) (AUX) into the jack labeled **AUX** on the card.
- In models with a wireless LAN card that has three antenna connectors, plug the black cable (1st) (MAIN) into the jack labeled **1**, the grey cable (3rd) into the jack labeled **3**, and the white cable (2nd) (AUX) into the jack labeled **2** on the card.

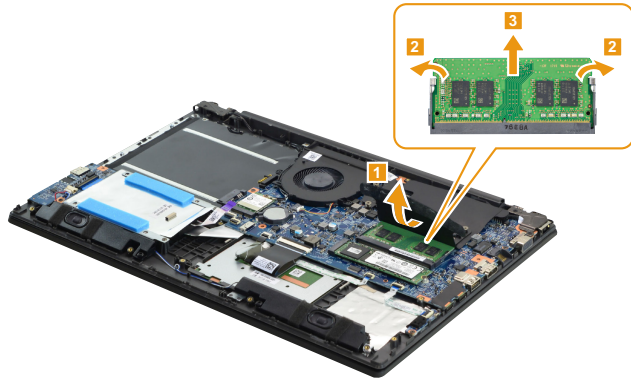
1070 DIMM

For access, remove these FRUs in order:

- “1010 Removable module (on select models)” on page 33
- “1020 Base cover” on page 35
- “1030 Battery pack” on page 38

Figure 7. Removal steps of DIMM

Peel off the tape **1**. Release the two latches on both edges of the socket at the same time in the directions shown by arrows **2**, and then unplug the DIMM in the direction shown by arrow **3**.



When installing: Insert the notched end of the DIMM into the socket. Push the DIMM firmly, and pivot it until it snaps into place. Make sure that it is firmly fixed in the slot and is difficult to move.

Note: When replacing the memory is completed, you need to restart the computer after the first reboot.

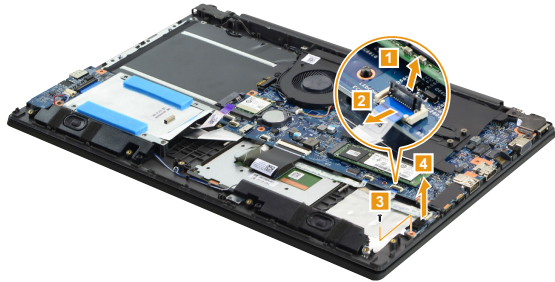
1080 LED board

For access, remove these FRUs in order:

- “1010 Removable module (on select models)” on page 33
- “1020 Base cover” on page 35
- “1030 Battery pack” on page 38

Figure 8. LED board

Detach the LED board connector in the directions shown by arrows **1** and **2**. Remove the screws **3**. Remove the LED board **4**.



Step	Screw (quantity)	Color	Torque
3	M2 × 3.0 mm, Phillips head, nylok-coated (1) LED board → C cover	Black	1.85±0.15 kgf*cm

When installing: Make sure that the connector is attached firmly.

1090 Speaker

For access, remove these FRUs in order:

- “1010 Removable module (on select models)” on page 33
- “1020 Base cover” on page 35
- “1030 Battery pack” on page 38

Figure 9. Removal steps of speaker

Unplug the speaker connector **1**. Remove the speaker **2**.



1100 IO board

For access, remove these FRUs in order:

- “1010 Removable module (on select models)” on page 33
- “1020 Base cover” on page 35
- “1030 Battery pack” on page 38
- “1090 Speaker” on page 47

Figure 10. Removal steps of IO board

Detach the IO board connector in the directions shown by arrows **1** and **2**.
Remove the screw **3**. Remove the IO board **4**.



Step	Screw (quantity)	Color	Torque
3	M2 × 5.0 mm, Phillips head, nylok-coated (1) IO board → C cover	Black	1.85±0.15 kgf*cm

When installing: Make sure that the connectors are attached firmly.

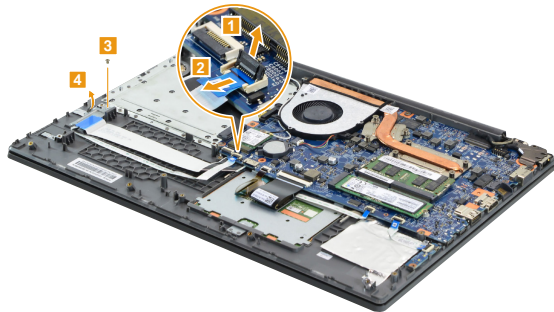
1110 Fingerprint module (on select models)

For access, remove these FRUs in order:

- “1010 Removable module (on select models)” on page 33
- “1020 Base cover” on page 35
- “1030 Battery pack” on page 38
- “1040 Hard disk drive” on page 40
- “1100 IO board” on page 48

Figure 11. Removal steps of fingerprint module (on select models)

Detach the connectors in the directions shown by arrows **1** and **2**. Then remove the screw **3** and peel off the tape **4**.

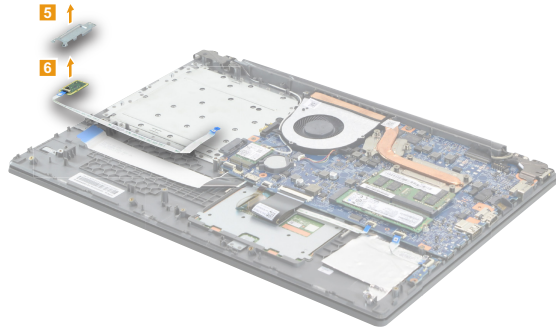


Step	Screw (quantity)	Color	Torque
3	M2 × 2.5 mm, Phillips head, nylok-coated (1) FINGER PRINT BRACKET → C cover	Silver	1.85±0.15 kg*cm

// Lenovo V330-15ISK/Lenovo V330-15IKB/Lenovo V130-15IGM/ Lenovo V130-15IKB Hardware Maintenance Manual

Figure 11. Removal steps of fingerprint module (on select models) (continued)

Remove the fingerprint bracket and fingerprint board in the direction shown by arrows **5** and **6**.



When installing: Make sure that the connector is attached firmly.

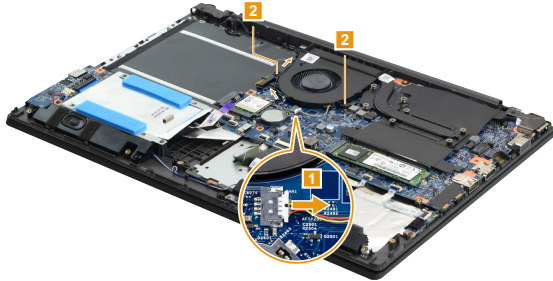
1120 Fan assembly

For access, remove these FRUs in order:

- “1010 Removable module (on select models)” on page 33
- “1020 Base cover” on page 35
- “1030 Battery pack” on page 38

Figure 12. Removal steps of fan assembly

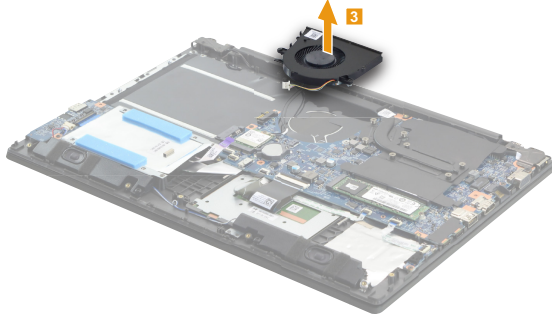
Unplug the fan connector in the direction shown by arrow **1**. Loosen the screws **2**. Release the fan cable from the cable guides.



// Lenovo V330-15ISK/Lenovo V330-15IKB/Lenovo V130-15IGM/ Lenovo V130-15IKB Hardware Maintenance Manual

Figure 12. Removal steps of fan assembly (continued)

Remove the fan in the direction shown by arrow **3**.



When installing: Make sure that the connectors are attached firmly.

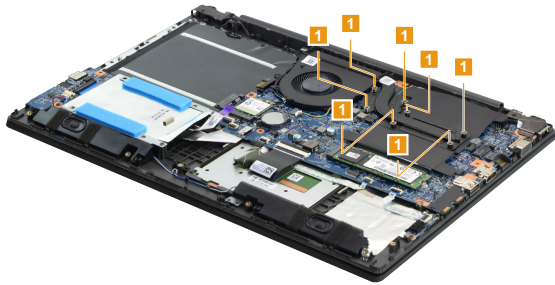
1130 Heat sink

For access, remove these FRUs in order:

- “1010 Removable module (on select models)” on page 33
- “1020 Base cover” on page 35
- “1030 Battery pack” on page 38

Figure 13. Removal steps of heat sink

Loosen the screws **1**.



Lift the heat sink in the direction shown by arrow **2**.

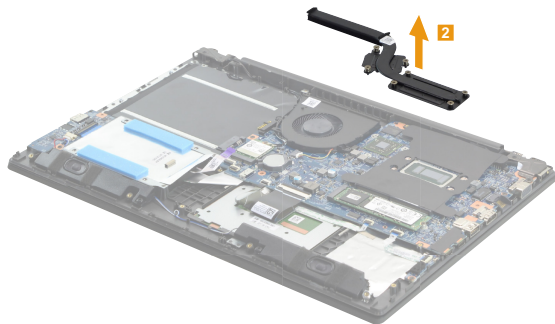
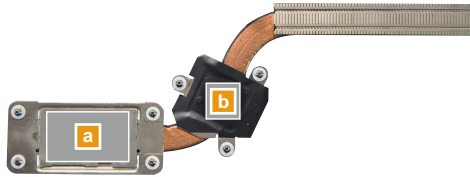


Figure 13. Removal steps of heat sink (continued)



When installing:

Before you attach the fan assembly to the computer, apply thermal grease, at an amount of 0.2 grams, to the **a** and **b** part shown in the figure above. Either too much or too little grease application can cause a thermal problem due to imperfect contact with a component.

1140 System board

Important notices for handling the system board:

When handling the system board, bear the following in mind.

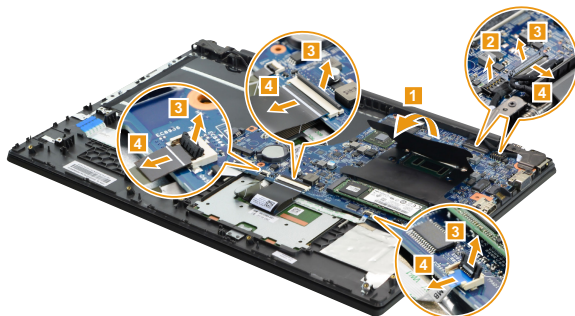
- Be careful not to drop the system board on a bench top that has a hard surface, such as metal, wood, or composite.
- Avoid rough handling of any kind.
- In the whole process, make sure not to drop or stack the system board.
- If you put a system board down, make sure to put it only on a padded surface such as an ESD mat or conductive corrugated material.

For access, remove these FRUs in order:

- “1010 Removable module (on select models)” on page 33
- “1020 Base cover” on page 35
- “1030 Battery pack” on page 38
- “1040 Hard disk drive” on page 40
- “1050 Solid state disk” on page 42
- “1060 PCI Express Mini Card for wireless LAN” on page 43
- “1080 LED board” on page 46
- “1090 Speaker” on page 47
- “1100 IO board” on page 48
- “1110 Fingerprint module (on select models)” on page 49
- “1120 Fan assembly” on page 51
- “1130 Heat sink” on page 53

Figure 14. Removal steps of system board

Peel off the tape in the direction shown by arrow **1**. Detach the five connectors in the directions shown by arrows **2**, **3** and **4**.



// Lenovo V330-15ISK/Lenovo V330-15IKB/Lenovo V130-15IGM/ Lenovo V130-15IKB Hardware Maintenance Manual

Figure 14. Removal steps of system board (continued)

Remove the screws **5** and **6**.



Step	Screw (quantity)	Color	Torque
5	M2 × 5.0 mm, Phillips head, nylok-coated (2) Hinge → C cover & Hinge → MB → C cover	Black	1.85±0.15 kgf*cm
6	M2 × 3.0 mm, Phillips head, nylok-coated (3) MB → C cover	Black	1.85±0.15 kgf*cm

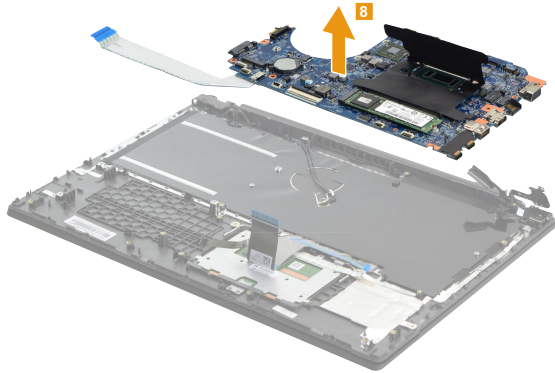
When installing: Make sure that the connectors are attached firmly.

Open the right hinge **7**.

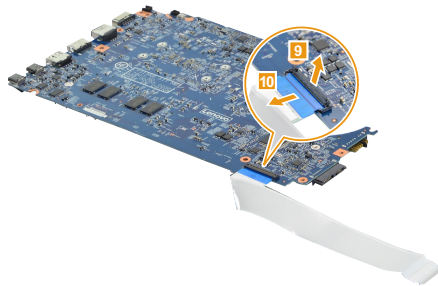


Figure 14. Removal steps of system board (continued)

Remove the system board **8**.



Carefully turn the system board over. Disconnect the IO board cable connector in the directions shown by arrows **9** and **10**.



1150 DC in cable and touchpad module

For access, remove these FRUs in order:

- “1010 Removable module (on select models)” on page 33
- “1020 Base cover” on page 35
- “1030 Battery pack” on page 38
- “1040 Hard disk drive” on page 40
- “1050 Solid state disk” on page 42
- “1060 PCI Express Mini Card for wireless LAN” on page 43
- “1080 LED board” on page 46
- “1090 Speaker” on page 47
- “1100 IO board” on page 48
- “1110 Fingerprint module (on select models)” on page 49
- “1120 Fan assembly” on page 51
- “1130 Heat sink” on page 53
- “1140 System board” on page 55

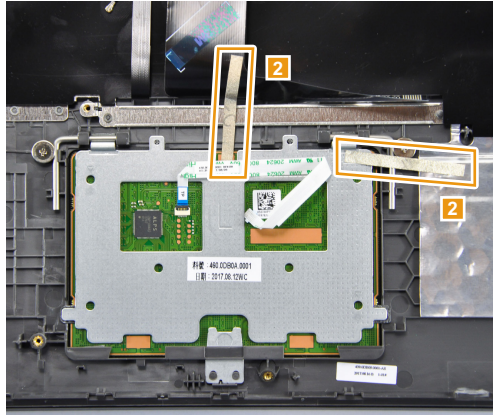
Figure 15. Removal steps of DC in cable and touchpad module

Remove the DC in cable **1**.



Figure 15. Removal steps of DC in cable and touchpad module (continued)

Remove the tape **2**.



Remove the screw **3**.

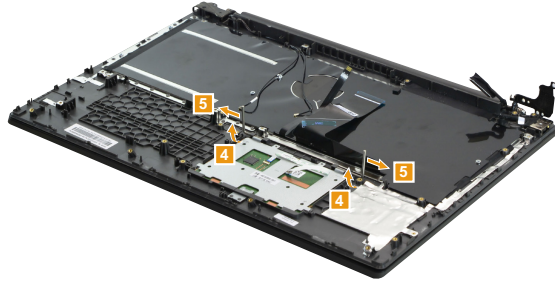


Step	Screw (quantity)	Color	Torque
3	M2.5 ×2.5 mm, Phillips head, nylok-coated (2) Fixed pin → C cover	Silver	3.0±0.3 kgf*cm

// Lenovo V330-15ISK/Lenovo V330-15IKB/Lenovo V130-15IGM/ Lenovo V130-15IKB Hardware Maintenance Manual

Figure 15. Removal steps of DC in cable and touchpad module (continued)

Open the fixed pin and take it away in the directions shown by arrows **4** and **5**.



Remove the touchpad module **6**.



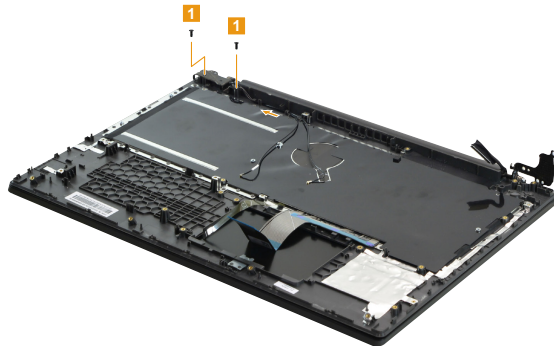
1160 Upper case

For access, remove these FRUs in order:

- “1010 Removable module (on select models)” on page 33
- “1020 Base cover” on page 35
- “1030 Battery pack” on page 38
- “1040 Hard disk drive” on page 40
- “1050 Solid state disk” on page 42
- “1060 PCI Express Mini Card for wireless LAN” on page 43
- “1080 LED board” on page 46
- “1090 Speaker” on page 47
- “1100 IO board” on page 48
- “1110 Fingerprint module (on select models)” on page 49
- “1120 Fan assembly” on page 51
- “1130 Heat sink” on page 53
- “1140 System board” on page 55
- “1150 DC in cable and touchpad module” on page 58

Figure 16. Removal steps of upper case

Remove the screws **1**. Release the antenna cables from the cable guides.

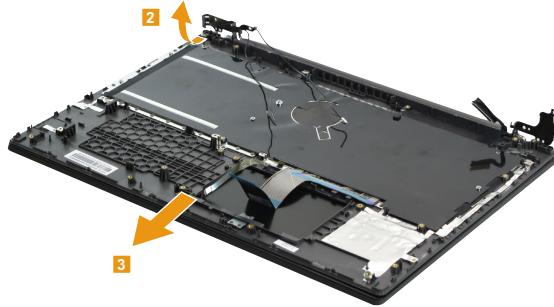


Step	Screw (quantity)	Color	Torque
1	M2 × 5.0 mm, Phillips head, nylok-coated (2) Hinge → C cover	Black	1.85±0.15 kgf*cm

// Lenovo V330-15ISK/Lenovo V330-15IKB/Lenovo V130-15IGM/ Lenovo V130-15IKB Hardware Maintenance Manual

Figure 16. Removal steps of upper case (continued)

Open the left hinge in the direction shown by arrow **2**. Remove the upper case from LCD unit in the direction shown by arrow **3**.



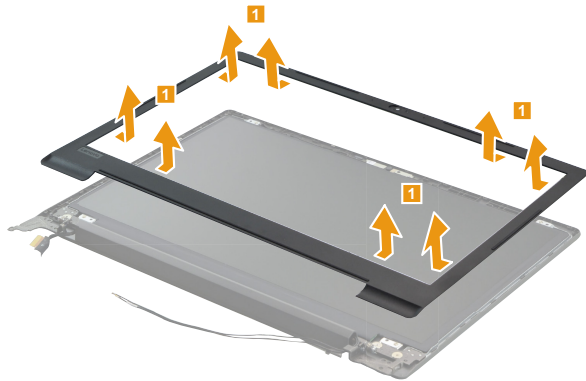
1170 LCD unit

For access, remove these FRUs in order:

- “1010 Removable module (on select models)” on page 33
- “1020 Base cover” on page 35
- “1030 Battery pack” on page 38
- “1040 Hard disk drive” on page 40
- “1050 Solid state disk” on page 42
- “1060 PCI Express Mini Card for wireless LAN” on page 43
- “1080 LED board” on page 46
- “1090 Speaker” on page 47
- “1100 IO board” on page 48
- “1110 Fingerprint module (on select models)” on page 49
- “1120 Fan assembly” on page 51
- “1130 Heat sink” on page 53
- “1140 System board” on page 55
- “1150 DC in cable and touchpad module” on page 58
- “1160 Upper case” on page 61

Figure 17. Removal steps of LCD unit

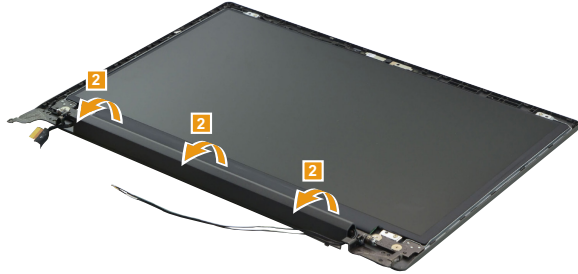
Remove the LCD front bezel in the direction shown by arrows **1**.



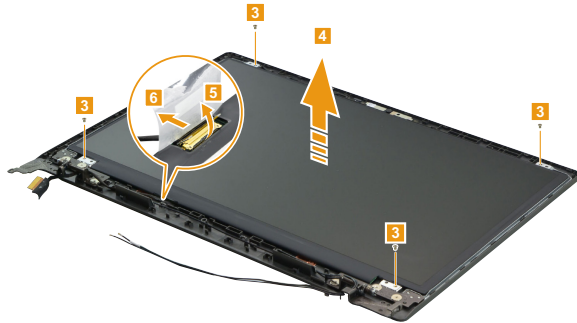
// Lenovo V330-15ISK/Lenovo V330-15IKB/Lenovo V130-15IGM/ Lenovo V130-15IKB Hardware Maintenance Manual

Figure 17. Removal steps of LCD unit (continued)

Remove the hinge cover in the direction shown by arrows **2**.



Remove the screws **3**. Lift the LCD panel slightly **4**. Peel off the adhesive tape. Open the latch on the EDP connector in the direction shown by arrow **5**, then unplug the EDP connector **6**. Then remove the LCD panel.



Step	Screw (quantity)	Color	Torque
3	M2 × 2.5 mm, Phillips head, nylok-coated (4) Lcd Panel → A cover	Silver	1.85±0.15 kg*cm

When installing: Make sure that the metal connector is attached firmly.

1180 EDP cable and integrated camera (on select models)

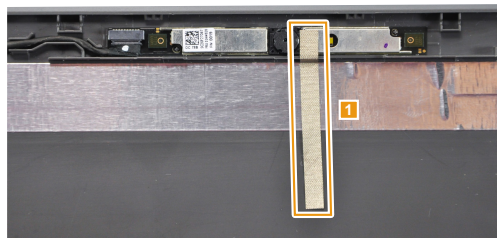
For access, remove these FRUs in order:

- “1010 Removable module (on select models)” on page 33
- “1020 Base cover” on page 35
- “1030 Battery pack” on page 38
- “1040 Hard disk drive” on page 40
- “1050 Solid state disk” on page 42
- “1060 PCI Express Mini Card for wireless LAN” on page 43
- “1080 LED board” on page 46
- “1090 Speaker” on page 47
- “1100 IO board” on page 48
- “1110 Fingerprint module (on select models)” on page 49
- “1120 Fan assembly” on page 51
- “1130 Heat sink” on page 53
- “1140 System board” on page 55
- “1150 DC in cable and touchpad module” on page 58
- “1160 Upper case” on page 61
- “1170 LCD unit” on page 63

Figure 18. Removal steps of EDP cable and integrated camera (on select models)

Note: The integrated camera is stuck on the top center of the LCD cover.

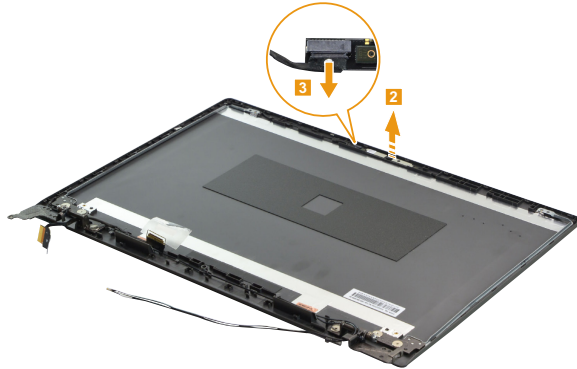
Peel off the tape **1**.



// Lenovo V330-15ISK/Lenovo V330-15IKB/Lenovo V130-15IGM/ Lenovo V130-15IKB Hardware Maintenance Manual

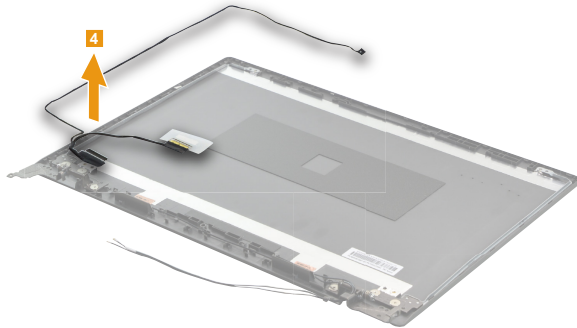
Figure 18. Removal steps of EDP cable and integrated camera (on select models) (continued)

Lift the camera board slightly **2** and unplug the connector in the direction shown by arrow **3**.



When installing: Stick the integrated camera to the top center of the LCD cover and adjust the placement of it to make sure the connector is attached firmly.

Remove the EDP cable **4**.



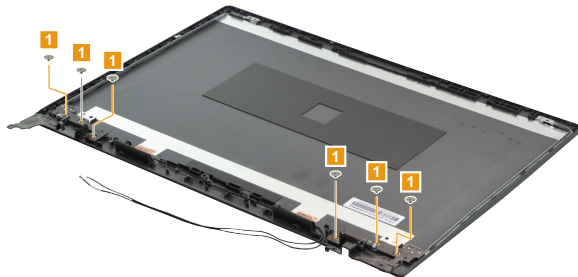
1190 LCD hinges

For access, remove these FRUs in order:

- “1010 Removable module (on select models)” on page 33
- “1020 Base cover” on page 35
- “1030 Battery pack” on page 38
- “1040 Hard disk drive” on page 40
- “1050 Solid state disk” on page 42
- “1060 PCI Express Mini Card for wireless LAN” on page 43
- “1080 LED board” on page 46
- “1090 Speaker” on page 47
- “1100 IO board” on page 48
- “1110 Fingerprint module (on select models)” on page 49
- “1120 Fan assembly” on page 51
- “1130 Heat sink” on page 53
- “1140 System board” on page 55
- “1150 DC in cable and touchpad module” on page 58
- “1160 Upper case” on page 61
- “1170 LCD unit” on page 63
- “1180 EDP cable and integrated camera (on select models)” on page 65

Figure 19. Removal steps of LCD hinges

Remove the screws **1**.

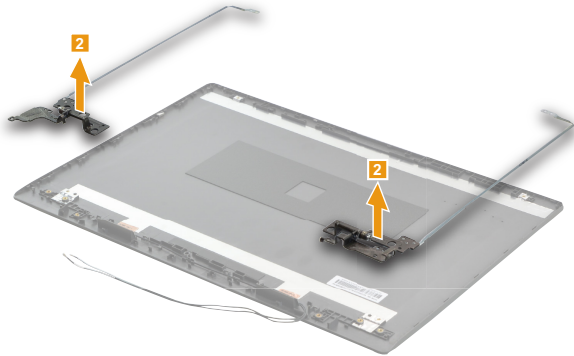


Step	Screw (quantity)	Color	Torque
1	M2.5 × 2.5 mm, Phillips head, nylok-coated (6) Hinge → A cover	Silver	3.0±0.3 kgf*cm

// Lenovo V330-15ISK/Lenovo V330-15IKB/Lenovo V130-15IGM/ Lenovo V130-15IKB Hardware Maintenance Manual

Figure 19. Removal steps of LCD hinges (continued)

Release the two hinges in the direction shown by arrows **2**.



Locations

Front and right-side view

- 1 Integrated camera (on select models)
- 2 Built-in microphone (on select models)
- 3 Computer display
- 4 Wireless LAN antennas
- 5 Power button
- 6 Touchpad
- 7 Memory card slot
- 8 Novo button
- 9 USB 3.0 port
- 10 Optical disk drive (on select models)
Removable battery (on select models)
Dummy case (on select models)
- 11 Kensington mini security slot



Bottom and left-side view

1 Optical disk drive/removable battery latch (on select models)

2 Speakers

3 System status indicators

Note: For a description of each indicator, see “Status indicators” on page 28.

4 Novo button

5 Type-C port (on select models)

6 Type-C port

7 USB 3.0 port (on select models)

8 HDMI port

9 RJ-45 port

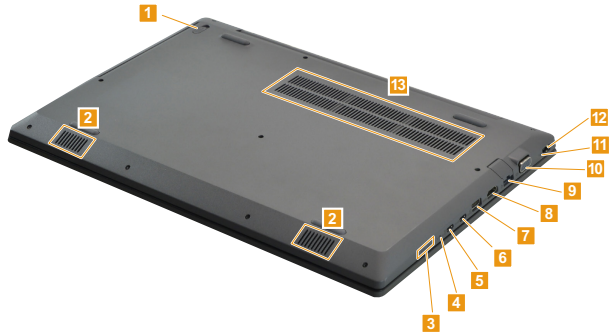
10 VGA port

11 Power status indicator

Note: For a description of each indicator, see “Status indicators” on page 28.

12 AC power adapter jack

13 Louvers



Parts list

This section presents the following service parts:

- “Overall” on page 72
- “LCD FRUs” on page 84
- “Miscellaneous parts” on page 86
- “AC adapters” on page 86
- “Screws” on page 86
- “Power cords” on page 87

Note:

Each FRU is available for all types or models, unless specific types or models are specified.

Attention:

Do not attempt to replace an FRU on your own. If an FRU is damaged, contact a Lenovo authorized servicer or a marketing representative for replacement or repair. Only qualified technicians can inspect or repair this product.

Overall

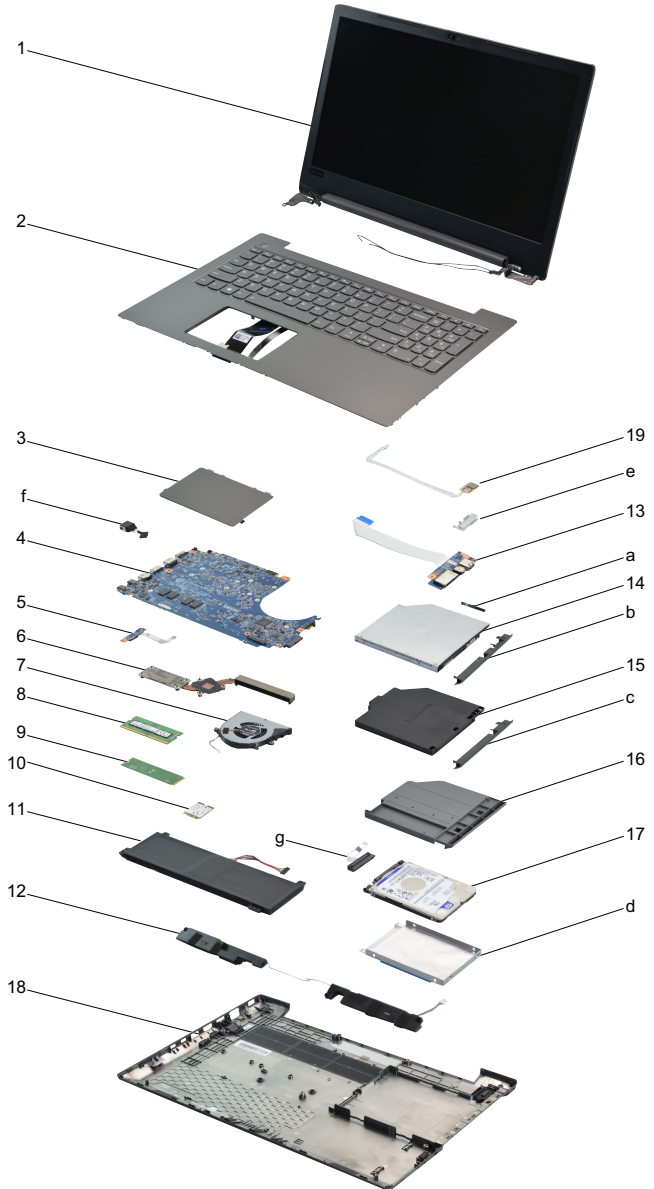


Table 5. Parts list—Overall

No.	FRU	FRU no.	CRU ID.	Lenovo V330-15ISK	Lenovo V330-15IKB	Lenovo V130-15IGM	Lenovo V130-15IKB
a-g	See "Miscellaneous parts" on page 86.						
1	LCD unit (see "LCD FRUs" on page 84.)						
2	UpperCase W 81AX IG W/KB NBL US	5CB0Q60195	N	•	•		
2	UpperCase W 81AX IG W/KB NBL UK	5CB0Q60130	N	•	•		
2	UpperCase W 81AX IG W/KB NBL IT	5CB0Q60229	N	•	•		
2	UpperCase W 81AX IG W/KB NBL SP	5CB0Q60182	N	•	•		
2	UpperCase W 81AX IG W/KB NBL TR	5CB0Q60133	N	•	•		
2	UpperCase W 81AX IG W/KB NBL TI	5CB0Q60054	N	•	•		
2	UpperCase W 81AX IG W/KB NBL PO	5CB0Q59976	N	•	•		
2	UpperCase W 81AX IG W/KB NBL LA	5CB0Q60217	N	•	•		
2	UpperCase W 81AX IG W/KB NBL CF-E	5CB0Q60243	N	•	•		
2	UpperCase W 81AX IG W/KB NBL KO	5CB0Q60111	N	•	•		
2	UpperCase W 81AX IG W/KB NBL CH	5CB0Q60006	N	•	•		
2	UpperCase W 81AX IG W/KB NBL RU	5CB0Q59975	N	•	•		
2	UpperCase W 81AX IG W/KB NBL FR	5CB0Q60022	N	•	•		
2	UpperCase W 81AX IG W/KB NBL GR	5CB0Q60020	N	•	•		
2	UpperCase W 81AX IG W/KB NBL AR-E	5CB0Q60203	N	•	•		
2	UpperCase W 81AX IG W/KB NBL BZ	5CB0Q59950	N	•	•		
2	UpperCase W 81AX IG W/KB NBL JP	5CB0Q60169	N	•	•		
2	UpperCase W 81AX IG W/KB NBL NL	5CB0Q60090	N	•	•		
2	UpperCase W 81AX IG W/KB NBL GK	5CB0Q60161	N	•	•		
2	UpperCase W 81AX IG W/KB NBL HB	5CB0Q60011	N	•	•		
2	UpperCase W 81AX IG W/KB NBL HG	5CB0Q59958	N	•	•		
2	UpperCase W 81AX IG W/KB NBL ND	5CB0Q60095	N	•	•		
2	UpperCase W 81AX IG W/KB NBL BE	5CB0Q59970	N	•	•		
2	UpperCase W 81AX IG W/KB NBL ICE	5CB0Q60023	N	•	•		
2	UpperCase W 81AX IG W/KB NBL SA	5CB0Q60048	N	•	•		
2	UpperCase W 81AX IG W/KB NBL SW	5CB0Q59983	N	•	•		
2	UpperCase W 81AX IG W/KB NBL UI	5CB0Q60080	N	•	•		
2	UpperCase W 81AX IG W/KB NBL CZ-SK	5CB0Q59957	N	•	•		
2	UpperCase W 81AX IG W/KB NBL BU	5CB0Q60068	N	•	•		
2	UpperCase W 81AX IG W/KB NBL IN	5CB0Q59989	N	•	•		
2	UpperCase W 81AX IG W/KB NBL AR-FR	5CB0Q59982	N	•	•		
2	UpperCase W 81AX IG W/KB NBL UA	5CB0Q59942	N	•	•		
2	UpperCase W 81AX IG W/KB BL US	5CB0Q60067	N	•	•		
2	UpperCase W 81AX IG W/KB BL USA	5CB0Q60242	N	•	•		
2	UpperCase W 81AX IG W/KB BL UK	5CB0Q59971	N	•	•		
2	UpperCase W 81AX IG W/KB BL IT	5CB0Q60165	N	•	•		
2	UpperCase W 81AX IG W/KB BL SP	5CB0Q60241	N	•	•		
2	UpperCase W 81AX IG W/KB BL TR	5CB0Q60126	N	•	•		
2	UpperCase W 81AX IG W/KB BL TI	5CB0Q60141	N	•	•		
2	UpperCase W 81AX IG W/KB BL PO	5CB0Q59999	N	•	•		
2	UpperCase W 81AX IG W/KB BL LA	5CB0Q60149	N	•	•		
2	UpperCase W 81AX IG W/KB BL CF-E	5CB0Q60087	N	•	•		
2	UpperCase W 81AX IG W/KB BL KO	5CB0Q60219	N	•	•		
2	UpperCase W 81AX IG W/KB BL CH	5CB0Q60166	N	•	•		
2	UpperCase W 81AX IG W/KB BL RU	5CB0Q59986	N	•	•		
2	UpperCase W 81AX IG W/KB BL FR	5CB0Q60024	N	•	•		

Lenovo V330-15ISK/Lenovo V330-15IKB/Lenovo V130-15IGM/ Lenovo V130-15IKB Hardware Maintenance Manual

Table 5. Parts list—Overall (continued)

No.	FRU	FRU no.	CRU ID.	Lenovo V330-15ISK	Lenovo V330-15IKB	Lenovo V130-15IGM	Lenovo V130-15IKB
2	UpperCase W 81AX IG W/KB BL GR	5CB0Q60192	N	•	•		
2	UpperCase W 81AX IG W/KB BL AR-E	5CB0Q60145	N	•	•		
2	UpperCase W 81AX IG W/KB BL BZ	5CB0Q60050	N	•	•		
2	UpperCase W 81AX IG W/KB BL JP	5CB0Q60079	N	•	•		
2	UpperCase W 81AX IG W/KB BL NL	5CB0Q60224	N	•	•		
2	UpperCase W 81AX IG W/KB BL GK	5CB0Q60248	N	•	•		
2	UpperCase W 81AX IG W/KB BL HB	5CB0Q60056	N	•	•		
2	UpperCase W 81AX IG W/KB BL HG	5CB0Q60030	N	•	•		
2	UpperCase W 81AX IG W/KB BL ND	5CB0Q59972	N	•	•		
2	UpperCase W 81AX IG W/KB BL BE	5CB0Q60260	N	•	•		
2	UpperCase W 81AX IG W/KB BL ICE	5CB0Q60104	N	•	•		
2	UpperCase W 81AX IG W/KB BL SA	5CB0Q60237	N	•	•		
2	UpperCase W 81AX IG W/KB BL SW	5CB0Q60132	N	•	•		
2	UpperCase W 81AX IG W/KB BL UI	5CB0Q59943	N	•	•		
2	UpperCase W 81AX IG W/KB BL CZ-SK	5CB0Q60211	N	•	•		
2	UpperCase W 81AX IG W/KB BL BU	5CB0Q60233	N	•	•		
2	UpperCase W 81AX IG W/KB BL IN	5CB0Q60202	N	•	•		
2	UpperCase W 81AX IG W/KB BL AR-FR	5CB0Q60140	N	•	•		
2	UpperCase W 81AX IG W/KB BL UA	5CB0Q60244	N	•	•		
2	UpperCase W 81AX MG W/KB NBL US	5CB0Q59960	N	•	•		
2	UpperCase W 81AX MG W/KB NBL UK	5CB0Q60032	N	•	•		
2	UpperCase W 81AX MG W/KB NBL IT	5CB0Q60046	N	•	•		
2	UpperCase W 81AX MG W/KB NBL SP	5CB0Q59955	N	•	•		
2	UpperCase W 81AX MG W/KB NBL TR	5CB0Q60007	N	•	•		
2	UpperCase W 81AX MG W/KB NBL TI	5CB0Q60085	N	•	•		
2	UpperCase W 81AX MG W/KB NBL PO	5CB0Q60158	N	•	•		
2	UpperCase W 81AX MG W/KB NBL LA	5CB0Q60055	N	•	•		
2	UpperCase W 81AX MG W/KB NBL CF-E	5CB0Q59954	N	•	•		
2	UpperCase W 81AX MG W/KB NBL KO	5CB0Q60100	N	•	•		
2	UpperCase W 81AX MG W/KB NBL CH	5CB0Q59985	N	•	•		
2	UpperCase W 81AX MG W/KB NBL RU	5CB0Q60075	N	•	•		
2	UpperCase W 81AX MG W/KB NBL FR	5CB0Q60106	N	•	•		
2	UpperCase W 81AX MG W/KB NBL GR	5CB0Q60142	N	•	•		
2	UpperCase W 81AX MG W/KB NBL AR-E	5CB0Q59939	N	•	•		
2	UpperCase W 81AX MG W/KB NBL BZ	5CB0Q60210	N	•	•		
2	UpperCase W 81AX MG W/KB NBL JP	5CB0Q60025	N	•	•		
2	UpperCase W 81AX MG W/KB NBL NL	5CB0Q60042	N	•	•		
2	UpperCase W 81AX MG W/KB NBL GK	5CB0Q60153	N	•	•		
2	UpperCase W 81AX MG W/KB NBL HB	5CB0Q60164	N	•	•		
2	UpperCase W 81AX MG W/KB NBL HG	5CB0Q59941	N	•	•		
2	UpperCase W 81AX MG W/KB NBL ND	5CB0Q60096	N	•	•		
2	UpperCase W 81AX MG W/KB NBL BE	5CB0Q60185	N	•	•		
2	UpperCase W 81AX MG W/KB NBL ICE	5CB0Q60063	N	•	•		
2	UpperCase W 81AX MG W/KB NBL SA	5CB0Q60163	N	•	•		
2	UpperCase W 81AX MG W/KB NBL SW	5CB0Q60113	N	•	•		
2	UpperCase W 81AX MG W/KB NBL UI	5CB0Q60206	N	•	•		
2	UpperCase W 81AX MG W/KB NBL CZ-SK	5CB0Q59980	N	•	•		
2	UpperCase W 81AX MG W/KB NBL BU	5CB0Q60253	N	•	•		

Table 5. Parts list—Overall (continued)

No.	FRU	FRU no.	CRU ID.	Lenovo V330-15ISK	Lenovo V330-15IKB	Lenovo V130-15IGM	Lenovo V130-15IKB
2	UpperCase W 81AX MG W/KB NBL IN	5CB0Q60227	N	•	•		
2	UpperCase W 81AX MG W/KB NBL AR-FR	5CB0Q60120	N	•	•		
2	UpperCase W 81AX MG W/KB NBL UA	5CB0Q60039	N	•	•		
2	UpperCase W 81AX MG W/KB BL US	5CB0Q59990	N	•	•		
2	UpperCase W 81AX MG W/KB BL USA	5CB0Q60117	N	•	•		
2	UpperCase W 81AX MG W/KB BL UK	5CB0Q60107	N	•	•		
2	UpperCase W 81AX MG W/KB BL IT	5CB0Q59994	N	•	•		
2	UpperCase W 81AX MG W/KB BL SP	5CB0Q60186	N	•	•		
2	UpperCase W 81AX MG W/KB BL TR	5CB0Q60167	N	•	•		
2	UpperCase W 81AX MG W/KB BL TI	5CB0Q60222	N	•	•		
2	UpperCase W 81AX MG W/KB BL PO	5CB0Q60190	N	•	•		
2	UpperCase W 81AX MG W/KB BL LA	5CB0Q60208	N	•	•		
2	UpperCase W 81AX MG W/KB BL CF-E	5CB0Q60175	N	•	•		
2	UpperCase W 81AX MG W/KB BL KO	5CB0Q60092	N	•	•		
2	UpperCase W 81AX MG W/KB BL CH	5CB0Q60091	N	•	•		
2	UpperCase W 81AX MG W/KB BL RU	5CB0Q60226	N	•	•		
2	UpperCase W 81AX MG W/KB BL FR	5CB0Q59977	N	•	•		
2	UpperCase W 81AX MG W/KB BL GR	5CB0Q60236	N	•	•		
2	UpperCase W 81AX MG W/KB BL AR-E	5CB0Q60047	N	•	•		
2	UpperCase W 81AX MG W/KB BL BZ	5CB0Q60021	N	•	•		
2	UpperCase W 81AX MG W/KB BL JP	5CB0Q60147	N	•	•		
2	UpperCase W 81AX MG W/KB BL NL	5CB0Q59965	N	•	•		
2	UpperCase W 81AX MG W/KB BL GK	5CB0Q60176	N	•	•		
2	UpperCase W 81AX MG W/KB BL HB	5CB0Q60216	N	•	•		
2	UpperCase W 81AX MG W/KB BL HG	5CB0Q60238	N	•	•		
2	UpperCase W 81AX MG W/KB BL ND	5CB0Q60000	N	•	•		
2	UpperCase W 81AX MG W/KB BL BE	5CB0Q59956	N	•	•		
2	UpperCase W 81AX MG W/KB BL ICE	5CB0Q60028	N	•	•		
2	UpperCase W 81AX MG W/KB BL SA	5CB0Q60008	N	•	•		
2	UpperCase W 81AX MG W/KB BL SW	5CB0Q59951	N	•	•		
2	UpperCase W 81AX MG W/KB BL UI	5CB0Q60122	N	•	•		
2	UpperCase W 81AX MG W/KB BL CZ-SK	5CB0Q59991	N	•	•		
2	UpperCase W 81AX MG W/KB BL BU	5CB0Q60014	N	•	•		
2	UpperCase W 81AX MG W/KB BL IN	5CB0Q60076	N	•	•		
2	UpperCase W 81AX MG W/KB BL AR-FR	5CB0Q60134	N	•	•		
2	UpperCase W 81AX MG W/KB BL UA	5CB0Q60084	N	•	•		
2	UpperCase W 81AX IG W/KB NFPNBL US	5CB0Q60097	N	•	•	•	
2	UpperCase W 81AX IG W/KB NFPNBL UK	5CB0Q60061	N	•	•		
2	UpperCase W 81AX IG W/KB NFPNBL IT	5CB0Q60072	N	•	•		
2	UpperCase W 81AX IG W/KB NFPNBL SP	5CB0Q60110	N	•	•		
2	UpperCase W 81AX IG W/KB NFPNBL TR	5CB0Q60235	N	•	•		
2	UpperCase W 81AX IG W/KB NFPNBL TI	5CB0Q59998	N	•	•		
2	UpperCase W 81AX IG W/KB NFPNBL PO	5CB0Q60033	N	•	•		
2	UpperCase W 81AX IG W/KB NFPNBL LA	5CB0Q60009	N	•	•		
2	UpperCase W 81AXIGW/KB NFPNBL CF-E	5CB0Q60016	N	•	•		
2	UpperCase W 81AX IG W/KB NFPNBL KO	5CB0Q60112	N	•	•		
2	UpperCase W 81AX IG W/KB NFPNBL CH	5CB0Q59963	N	•	•		

Lenovo V330-15ISK/Lenovo V330-15IKB/Lenovo V130-15IGM/ Lenovo V130-15IKB Hardware Maintenance Manual

Table 5. Parts list—Overall (continued)

No.	FRU	FRU no.	CRU ID.	Lenovo V330-15ISK	Lenovo V330-15IKB	Lenovo V130-15IGM	Lenovo V130-15IKB
2	UpperCase W 81AX IG W/KB NFPNBL RU	5CB0Q60043	N	•	•		
2	UpperCase W 81AX IG W/KB NFPNBL FR	5CB0Q60194	N	•	•		
2	UpperCase W 81AX IG W/KB NFPNBL GR	5CB0Q60220	N	•	•		
2	UpperCase W 81AXIGW/KB NFPNBL AR-E	5CB0Q60152	N	•	•		
2	UpperCase W 81AX IG W/KB NFPNBL BZ	5CB0Q60212	N	•	•		
2	UpperCase W 81AX IG W/KB NFPNBL JP	5CB0Q60040	N	•	•		
2	UpperCase W 81AX IG W/KB NFPNBL NL	5CB0Q60179	N	•	•		
2	UpperCase W 81AX IG W/KB NFPNBL GK	5CB0Q60001	N	•	•		
2	UpperCase W 81AX IG W/KB NFPNBL HB	5CB0Q60196	N	•	•		
2	UpperCase W 81AX IG W/KB NFPNBL HG	5CB0Q60156	N	•	•		
2	UpperCase W 81AX IG W/KB NFPNBL ND	5CB0Q59962	N	•	•		
2	UpperCase W 81AX IG W/KB NFPNBL BE	5CB0Q60123	N	•	•		
2	UpperCase W 81AX IGW/KB NFPNBL ICE	5CB0Q60180	N	•	•		
2	UpperCase W 81AX IG W/KB NFPNBL SA	5CB0Q60168	N	•	•		
2	UpperCase W 81AX IG W/KB NFPNBL SW	5CB0Q60077	N	•	•		
2	UpperCase W 81AX IG W/KB NFPNBL UI	5CB0Q60231	N	•	•		
2	UpperCase W 81AXIGW/KBNFPNBL CZ-SK	5CB0Q60223	N	•	•		
2	UpperCase W 81AX IG W/KB NFPNBL BU	5CB0Q60088	N	•	•		
2	UpperCase W 81AX IG W/KB NFPNBL IN	5CB0Q60221	N	•	•		
2	UpperCase W 81AXIGW/KBNFPNBL AR-FR	5CB0Q59953	N	•	•		
2	UpperCase W 81AXIGW/KBNFPNBL UA	5CB0Q59978	N	•	•		
2	UpperCase W 81AX IG W/KB NFP BL US	5CB0Q60250	N	•	•		
2	UpperCase W 81AX IG W/KB NFPBL USA	5CB0Q60083	N	•	•		
2	UpperCase W 81AX IG W/KB NFP BL UK	5CB0Q60200	N	•	•		
2	UpperCase W 81AX IG W/KB NFP BL IT	5CB0Q60225	N	•	•		
2	UpperCase W 81AX IG W/KB NFP BL SP	5CB0Q60136	N	•	•		
2	UpperCase W 81AX IG W/KB NFP BL TR	5CB0Q60027	N	•	•		
2	UpperCase W 81AX IG W/KB NFP BL TI	5CB0Q59993	N	•	•		
2	UpperCase W 81AX IG W/KB NFP BL PO	5CB0Q59969	N	•	•		
2	UpperCase W 81AX IG W/KB NFP BL LA	5CB0Q59997	N	•	•		
2	UpperCase W 81AX IGW/KB NFPBL CF-E	5CB0Q60044	N	•	•		
2	UpperCase W 81AX IG W/KB NFP BL KO	5CB0Q60143	N	•	•		
2	UpperCase W 81AX IG W/KB NFP BL CH	5CB0Q60098	N	•	•		
2	UpperCase W 81AX IG W/KB NFP BL RU	5CB0Q60137	N	•	•		
2	UpperCase W 81AX IG W/KB NFP BL FR	5CB0Q60125	N	•	•		
2	UpperCase W 81AX IG W/KB NFP BL GR	5CB0Q60026	N	•	•		
2	UpperCase W 81AX IGW/KB NFPBL AR-E	5CB0Q60213	N	•	•		
2	UpperCase W 81AX IG W/KB NFP BL BZ	5CB0Q60187	N	•	•		
2	UpperCase W 81AX IG W/KB NFP BL JP	5CB0Q60103	N	•	•		
2	UpperCase W 81AX IG W/KB NFP BL NL	5CB0Q60038	N	•	•		
2	UpperCase W 81AX IG W/KB NFP BL GK	5CB0Q60162	N	•	•		
2	UpperCase W 81AX IG W/KB NFP BL HB	5CB0Q59961	N	•	•		
2	UpperCase W 81AX IG W/KB NFP BL HG	5CB0Q59987	N	•	•		
2	UpperCase W 81AX IG W/KB NFP BL ND	5CB0Q60108	N	•	•		
2	UpperCase W 81AX IG W/KB NFP BL BE	5CB0Q60037	N	•	•		
2	UpperCase W 81AX IG W/KB NFPBL ICE	5CB0Q60188	N	•	•		
2	UpperCase W 81AX IG W/KB NFP BL SA	5CB0Q59974	N	•	•		
2	UpperCase W 81AX IG W/KB NFP BL SW	5CB0Q60258	N	•	•		

Table 5. Parts list—Overall (continued)

No.	FRU	FRU no.	CRU ID.	Lenovo V330-15ISK	Lenovo V330-15IKB	Lenovo V130-15IGM	Lenovo V130-15IKB
2	UpperCase W 81AX IG W/KB NFP BL UI	5CB0Q60170	N	•	•		
2	UpperCase W 81AXIGW/KB NFPBL CZ-SK	5CB0Q60018	N	•	•		
2	UpperCase W 81AX IG W/KB NFP BL BU	5CB0Q59940	N	•	•		
2	UpperCase W 81AX IG W/KB NFP BL IN	5CB0Q59947	N	•	•		
2	UpperCase W 81AXIGW/KB NFPBL AR-FR	5CB0Q60013	N	•	•		
2	UpperCase W 81AX IG W/KB NFP BL UA	5CB0Q60034	N	•	•		
2	UpperCase W 81AX MG W/KB NFPNBL US	5CB0Q60148	N	•	•		
2	UpperCase W 81AX MG W/KB NFPNBL UK	5CB0Q60252	N	•	•		
2	UpperCase W 81AX MG W/KB NFPNBL IT	5CB0Q60081	N	•	•		
2	UpperCase W 81AX MG W/KB NFPNBL SP	5CB0Q60029	N	•	•		
2	UpperCase W 81AX MG W/KB NFPNBL TR	5CB0Q60197	N	•	•		
2	UpperCase W 81AX MG W/KB NFPNBL TI	5CB0Q60045	N	•	•		
2	UpperCase W 81AX MG W/KB NFPNBL PO	5CB0Q60017	N	•	•		
2	UpperCase W 81AX MG W/KB NFPNBL LA	5CB0Q59995	N	•	•		
2	UpperCase W 81AXMGW/KB NFPNBL CF-E	5CB0Q60171	N	•	•		
2	UpperCase W 81AX MG W/KB NFPNBL KO	5CB0Q60005	N	•	•		
2	UpperCase W 81AX MG W/KB NFPNBL CH	5CB0Q60010	N	•	•		
2	UpperCase W 81AX MG W/KB NFPNBL RU	5CB0Q60254	N	•	•		
2	UpperCase W 81AX MG W/KB NFPNBL FR	5CB0Q60116	N	•	•		
2	UpperCase W 81AX MG W/KB NFPNBL GR	5CB0Q60157	N	•	•		
2	UpperCase W 81AXMGW/KB NFPNBL AR-E	5CB0Q59992	N	•	•		
2	UpperCase W 81AX MG W/KB NFPNBL BZ	5CB0Q60228	N	•	•		
2	UpperCase W 81AX MG W/KB NFPNBL JP	5CB0Q59966	N	•	•		
2	UpperCase W 81AX MG W/KB NFPNBL NL	5CB0Q59984	N	•	•		
2	UpperCase W 81AX MG W/KB NFPNBL GK	5CB0Q60199	N	•	•		
2	UpperCase W 81AX MG W/KB NFPNBL HB	5CB0Q60041	N	•	•		
2	UpperCase W 81AX MG W/KB NFPNBL HG	5CB0Q60031	N	•	•		
2	UpperCase W 81AX MG W/KB NFPNBL ND	5CB0Q59945	N	•	•		
2	UpperCase W 81AX MG W/KB NFPNBL BE	5CB0Q60070	N	•	•		
2	UpperCase W 81AX MGW/KB NFPNBL ICE	5CB0Q60121	N	•	•		
2	UpperCase W 81AX MG W/KB NFPNBL SA	5CB0Q60160	N	•	•		
2	UpperCase W 81AX MG W/KB NFPNBL SW	5CB0Q60064	N	•	•		
2	UpperCase W 81AX MG W/KB NFPNBL UI	5CB0Q60251	N	•	•		
2	UpperCase W 81AXMGW/KBNFPNBL CZ-SK	5CB0Q60155	N	•	•		
2	UpperCase W 81AX MG W/KB NFPNBL BU	5CB0Q60255	N	•	•		
2	UpperCase W 81AX MG W/KB NFPNBL IN	5CB0Q60003	N	•	•		
2	UpperCase W 81AXMGW/KBNFPNBL AR-FR	5CB0Q60118	N	•	•		
2	UpperCase W 81AX MG W/KB NFPNBL UA	5CB0Q60086	N	•	•		
2	UpperCase W 81AX MG W/KB NFP BL US	5CB0Q60139	N	•	•		
2	UpperCase W 81AX MG W/KB NFPBL USA	5CB0Q60232	N	•	•		
2	UpperCase W 81AX MG W/KB NFP BL UK	5CB0Q60059	N	•	•		
2	UpperCase W 81AX MG W/KB NFP BL IT	5CB0Q59979	N	•	•		
2	UpperCase W 81AX MG W/KB NFP BL SP	5CB0Q60214	N	•	•		
2	UpperCase W 81AX MG W/KB NFP BL TR	5CB0Q60230	N	•	•		
2	UpperCase W 81AX MG W/KB NFP BL TI	5CB0Q60259	N	•	•		
2	UpperCase W 81AX MG W/KB NFP BL PO	5CB0Q60245	N	•	•		
2	UpperCase W 81AX MG W/KB NFP BL LA	5CB0Q59952	N	•	•		

Lenovo V330-15ISK/Lenovo V330-15IKB/Lenovo V130-15IGM/ Lenovo V130-15IKB Hardware Maintenance Manual

Table 5. Parts list—Overall (continued)

No.	FRU	FRU no.	CRU ID.	Lenovo V330-15ISK	Lenovo V330-15IKB	Lenovo V130-15IGM	Lenovo V130-15IKB
2	UpperCase W 81AX MGW/KB NFPBL CF-E	5CB0Q60193	N	•	•		
2	UpperCase W 81AX MG W/KB NFP BL KO	5CB0Q60201	N	•	•		
2	UpperCase W 81AX MG W/KB NFP BL CH	5CB0Q60178	N	•	•		
2	UpperCase W 81AX MG W/KB NFP BL RU	5CB0Q60082	N	•	•		
2	UpperCase W 81AX MG W/KB NFP BL FR	5CB0Q60198	N	•	•		
2	UpperCase W 81AX MG W/KB NFP BL GR	5CB0Q59959	N	•	•		
2	UpperCase W 81AX MGW/KB NFPBL AR-E	5CB0Q60181	N	•	•		
2	UpperCase W 81AX MG W/KB NFP BL BZ	5CB0Q60019	N	•	•		
2	UpperCase W 81AX MG W/KB NFP BL JP	5CB0Q60135	N	•	•		
2	UpperCase W 81AX MG W/KB NFP BL NL	5CB0Q60150	N	•	•		
2	UpperCase W 81AX MG W/KB NFP BL GK	5CB0Q60256	N	•	•		
2	UpperCase W 81AX MG W/KB NFP BL HB	5CB0Q60215	N	•	•		
2	UpperCase W 81AX MG W/KB NFP BL HG	5CB0Q60218	N	•	•		
2	UpperCase W 81AX MG W/KB NFP BL ND	5CB0Q60127	N	•	•		
2	UpperCase W 81AX MG W/KB NFP BL BE	5CB0Q60078	N	•	•		
2	UpperCase W 81AX MG W/KB NFPBL ICE	5CB0Q60015	N	•	•		
2	UpperCase W 81AX MG W/KB NFP BL SA	5CB0Q60177	N	•	•		
2	UpperCase W 81AX MG W/KB NFP BL SW	5CB0Q60204	N	•	•		
2	UpperCase W 81AX MG W/KB NFP BL UI	5CB0Q60151	N	•	•		
2	UpperCase W 81AXMGW/KB NFPBL CZ-SK	5CB0Q60089	N	•	•		
2	UpperCase W 81AX MG W/KB NFP BL BU	5CB0Q60172	N	•	•		
2	UpperCase W 81AX MG W/KB NFP BL IN	5CB0Q600074	N	•	•		
2	UpperCase W 81AXMGW/KB NFPBL AR-FR	5CB0Q60073	N	•	•		
2	UpperCase W 81AX MG W/KB NFP BL UA	5CB0Q59948	N	•	•		
2	UpperCase W81HL NFP IG NBL W/KB US	5CB0R28214	N				•
2	UpperCase W81HL NFP IG NBL W/KB UK	5CB0R28201	N				•
2	UpperCase W81HL NFP IG NBL W/KB IT	5CB0R28215	N				•
2	UpperCase W81HL NFP IG NBL W/KB SP	5CB0R28205	N				•
2	UpperCase W81HL NFP IG NBL W/KB TR	5CB0R28219	N				•
2	UpperCase W81HL NFP IG NBL W/KB TH	5CB0R28204	N				•
2	UpperCase W81HL NFP IG NBL W/KB PO	5CB0R28223	N				•
2	UpperCase W81HL NFP IG NBL W/KB LA	5CB0R28195	N				•
2	UpperCaseW81HL NFP IG NBL W/KBCF-E	5CB0R28218	N				•
2	UpperCase W81HL NFP IG NBL W/KB KO	5CB0R28211	N				•
2	UpperCase W81HL NFP IG NBL W/KB TC	5CB0R28220	N				•
2	UpperCase W81HL NFP IG NBL W/KB RU	5CB0R28226	N				•
2	UpperCase W81HL NFP IG NBL W/KB FR	5CB0R28212	N				•
2	UpperCase W81HL NFP IG NBL W/KB GR	5CB0R28196	N				•
2	UpperCase W81HL NFP IG NBLW/KBAR-E	5CB0R28197	N				•
2	UpperCase W81HL NFP IG NBL W/KB JP	5CB0R33016	N				•
2	UpperCaseW 81HN NFP IG NBL W/KB NL	5CB0R33562	N				•
2	UpperCase W81HL NFP IG NBL W/KB GK	5CB0R28221	N				•
2	UpperCase W81HL NFP IG NBL W/KB HE	5CB0R28198	N				•
2	UpperCase W81HL NFP IG NBL W/KB HG	5CB0R28224	N				•
2	UpperCase W81HL NFP IG NBL W/KB ND	5CB0R28199	N				•
2	UpperCase W81HL NFP IG NBL W/KB BE	5CB0R28200	N				•
2	UpperCase W81HL NFP IG NBL W/KBICE	5CB0R28222	N				•

Table 5. Parts list—Overall (continued)

No.	FRU	FRU no.	CRU ID.	Lenovo V330-15ISK	Lenovo V330-15IKB	Lenovo V130-15IGM	Lenovo V130-15IKB
2	UpperCase W81HL NFP IG NBL W/KB SA	5CB0R28202	N				•
2	UpperCase W81HL NFP IG NBL W/KB SW	5CB0R28217	N				•
2	UpperCase W81HL NFP IG NBL W/KBUSI	5CB0R28209	N				•
2	UpperCaseW81HL NFP IG NBLW/KBCZ-SK	5CB0R28216	N				•
2	UpperCase W81HL NFP IG NBL W/KB BU	5CB0R28207	N				•
2	UpperCaseW81HL NFP IG NBLW/KBINDIA	5CB0R28203	N				•
2	UpperCaseW81HL NFP IG NBLW/KBAR-FR	5CB0R28208	N				•
2	UpperCaseW81HL NFP IG NBL W/KB UKR	5CB0R28210	N				•
3	TP Module W 81AX W/Cable IG	5T60Q60209	N	•	•	•	•
3	TP Module W 81AX W/Cable MG	5T60Q59967	N	•	•		
4	MBW81AW NOK I36006U 2G4GTEX-FTC	5B20Q62181	N	•			
4	MBW81AW NOKI36006U UMA4GTEX-FTC	5B20Q62161	N	•			
4	MBW81AW NOK I56267U 2G4GTEX-FTC	5B20Q62179	N	•			
4	MBW81AW NOK I56300U 2G4GTEX-FTC	5B20Q62182	N	•			
4	MBW81AW NOKI56300U UMA4GTEX-FTC	5B20Q62162	N	•			
4	MBW81AW NOK I76567U 2G4GTEX-FTC	5B20Q62169	N	•			
4	MBW81AW NOKI36006U 2G4GTEX-NFTC	5B20Q62164	N	•			
4	MBW81AWNOKI36006U UMA4GTEX-NFTC	5B20Q62166	N	•			
4	MBW81AW NOKI56267U 2G4GTEX-NFTC	5B20Q62167	N	•			
4	MBW81AW NOKI56300U 2G4GTEX-NFTC	5B20Q62176	N	•			
4	MBW81AWNOKI56300U UMA4GTEX-NFTC	5B20Q62173	N	•			
4	MBW81AW NOKI76567U 2G4GTEX-NFTC	5B20Q62171	N	•			
4	MBW81AW WIN I36006U 2G4GTEX-FTC	5B20Q62177	N	•			
4	MBW81AW WINI36006U UMA4GTEX-FTC	5B20Q62160	N	•			
4	MBW81AW WIN I56267U 2G4GTEX-FTC	5B20Q62159	N	•			
4	MBW81AW WIN I56300U 2G4GTEX-FTC	5B20Q62168	N	•			
4	MBW81AW WINI56300U UMA4GTEX-FTC	5B20Q62170	N	•			
4	MBW81AW WIN I76567U 2G4GTEX-FTC	5B20Q62180	N	•			
4	MBW81AW WINI36006U 2G4GTEX-NFTC	5B20Q62163	N	•			
4	MBW81AWWINI36006U UMA4GTEX-NFTC	5B20Q62165	N	•			
4	MBW81AW WINI56267U 2G4GTEX-NFTC	5B20Q62172	N	•			
4	MBW81AW WINI56300U 2G4GTEX-NFTC	5B20Q62174	N	•			
4	MBW81AWWINI56300U UMA4GTEX-NFTC	5B20Q62175	N	•			
4	MBW81AW WINI76567U 2G4GTEX-NFTC	5B20Q62178	N	•			
4	MB W81AX WIN3865U TEX-FTC UMA4G	5B20Q60191	N		•		
4	MB W81AX WIN4415U TEX-FTC UMA4G	5B20Q60173	N		•		
4	MB W81AX WIN13-7130UTEX-FTC2G4G	5B20Q60065	N		•		
4	MBW81AXWIN13-7130UTEX-FTC UMA4G	5B20Q60066	N		•		
4	MBW81AXWIN15-7200U TEX-FTC 2G4G	5B20Q60189	N		•		
4	MBW81AXWIN15-7200U TEX-FTCUMA4G	5B20Q60246	N		•		
4	MBW81AXWIN15-7300U TEX-FTC 2G4G	5B20Q60183	N		•		
4	MBW81AXWIN15-7300U TEX-FTCUMA4G	5B20Q60094	N		•		
4	MBW81AXWIN15-8250U TEX-FTC 2G4G	5B20Q60051	N		•		
4	MBW81AXWIN15-8250U TEX-FTCUMA4G	5B20Q60071	N		•		
4	MBW81AXWIN17-8550U TEX-FTC 2G4G	5B20Q60012	N		•		
4	MBW81AXWIN17-8550U TEX-FTCUMA4G	5B20Q60119	N		•		
4	MBW81AXWIN 3865U TEX-NFTC UMA4G	5B20Q59996	N		•		

Lenovo V330-15ISK/Lenovo V330-15IKB/Lenovo V130-15IGM/ Lenovo V130-15IKB Hardware Maintenance Manual

Table 5. Parts list—Overall (continued)

No.	FRU	FRU no.	CRU ID.	Lenovo V330-15ISK	Lenovo V330-15IKB	Lenovo V130-15IGM	Lenovo V130-15IKB
4	MBW81AXWIN 4415U TEX-NFTC UMA4G	5B20Q60060	N		•		
4	MBW81AXWIN13-7130U TEX-NFTC2G4G	5B20Q60069	N		•		
4	MBW81AXWIN13-7130U TEX-NFTCUMA4G	5B20Q60128	N		•		
4	MBW81AXWIN15-7200U TEX-NFTC2G4G	5B20Q60144	N		•		
4	MBW81AXWIN15-7200U TEX-NFTCUMA4G	5B20Q60174	N		•		
4	MBW81AXWIN15-7300U TEX-NFTC2G4G	5B20Q60154	N		•		
4	MBW81AXWIN15-7300U TEX-NFTCUMA4G	5B20Q60052	N		•		
4	MBW81AXWIN15-8250U TEX-NFTC2G4G	5B20Q60049	N		•		
4	MBW81AXWIN15-8250U TEX-NFTCUMA4G	5B20Q60035	N		•		
4	MBW81AXWIN17-8550U TEX-NFTC2G4G	5B20Q60240	N		•		
4	MBW81AXWIN17-8550U TEX-NFTCUMA4G	5B20Q60093	N		•		
4	MB W81AX NOK3865U TEX-FTC UMA4G	5B20Q68394	N		•		
4	MB W81AX NOK4415U TEX-FTC UMA4G	5B20Q68411	N		•		
4	MB W81AX NOK13-7130U TEX-FTC2G4G	5B20Q68412	N		•		
4	MBW81AXNOK13-7130U TEX-FTC UMA4G	5B20Q68406	N		•		
4	MBW81AXNOK15-7200U TEX-FTC 2G4G	5B20Q68413	N		•		
4	MBW81AXNOK15-7200U TEX-FTCUMA4G	5B20Q68392	N		•		
4	MBW81AXNOK15-7300U TEX-FTC 2G4G	5B20Q68407	N		•		
4	MBW81AXNOK15-7300U TEX-FTCUMA4G	5B20Q68400	N		•		
4	MBW81AXNOK15-8250U TEX-FTC 2G4G	5B20Q68390	N		•		
4	MBW81AXNOK15-8250U TEX-FTCUMA4G	5B20Q68402	N		•		
4	MBW81AXNOK17-8550U TEX-FTC 2G4G	5B20Q68403	N		•		
4	MBW81AXNOK17-8550U TEX-FTCUMA4G	5B20Q68408	N		•		
4	MBW81AXNOK 3865U TEX-NFTC UMA4G	5B20Q68395	N		•		
4	MBW81AXNOK 4415U TEX-NFTC UMA4G	5B20Q68399	N		•		
4	MBW81AXNOK13-7130U TEX-NFTC2G4G	5B20Q68391	N		•		
4	MBW81AXNOK13-7130U TEX-NFTCUMA4G	5B20Q68396	N		•		
4	MBW81AXNOK15-7200U TEX-NFTC2G4G	5B20Q68397	N		•		
4	MBW81AXNOK15-7200U TEX-NFTCUMA4G	5B20Q68398	N		•		
4	MBW81AXNOK15-7300U TEX-NFTC2G4G	5B20Q68401	N		•		
4	MBW81AXNOK15-7300U TEX-NFTCUMA4G	5B20Q68409	N		•		
4	MBW81AXNOK15-8250U TEX-NFTC2G4G	5B20Q68404	N		•		
4	MBW81AXNOK15-8250U TEX-NFTCUMA4G	5B20Q68393	N		•		
4	MBW81AXNOK17-8550U TEX-NFTC2G4G	5B20Q68405	N		•		
4	MBW81AXNOK17-8550U TEX-NFTCUMA4G	5B20Q68410	N		•		
4	MB W 81B4 NOK N4000 UMA	5B20R28074	N			•	
4	MB W 81B4 NOK N4100 UMA	5B20R28082	N			•	
4	MB W 81B4 NOK N5000 UMA	5B20R28084	N			•	
4	MB W 81B4 WIN N4000 UMA	5B20R28085	N			•	
4	MB W 81B4 WIN N4100 UMA	5B20R28077	N			•	
4	MB W 81B4 WIN N5000 UMA	5B20R28079	N			•	
4	MB W 81HN NOK 3865U UMA 4G	5B20R33560	N				•
4	MB W 81HN NOK 4415U UMA 4G	5B20R33553	N				•
4	MB W 81HN NOK I3-7020U UMA 4G	5B20R33556	N				•
4	MBW81HNNOKI37020URADEON530 2G4G	5B20R33549	N				•

Table 5. Parts list—Overall (continued)

No.	FRU	FRU no.	CRU ID.	Lenovo V330-15ISK	Lenovo V330-15IKB	Lenovo V130-15IGM	Lenovo V130-15IKB
4	MB W 81HN NOK I57200U UMA 4G	5B20R33558	N				•
4	MBW81HNNOKI57200URADEON530 2G4G	5B20R33557	N				•
4	MB W 81HN WIN 3865U UMA 4G	5B20R33554	N				•
4	MB W 81HN WIN 4415U UMA 4G	5B20R33551	N				•
4	MB W 81HN WIN I3-7020U UMA 4G	5B20R33559	N				•
4	MBW81HNWINI37020URADEON530 2G4G	5B20R33555	N				•
4	MB W 81HN WIN I57200U UMA 4G	5B20R33550	N				•
4	MBW81HNWINI57200URADEON530 2G4G	5B20R33564	N				•
5	LED Board W 81AX W/Cable	5C50Q60057	N	•	•		•
5	LED Board W 81B4 W/Cable	5C50R28078	N			•	
6	Heatsink W 81AX DIS	5H40Q60036	N	•	•		
6	Heatsink W 81AX U42 15W UMA	5H40Q60205	N		•		
6	Heatsink W 81AX U22 15W UMA	5H40Q60129	N	•	•		
6	Heatsink W 81B4 UMA	5H40R28083	N			•	
6	Heatsink W 81HN DIS	5H40R33552	N				•
6	Heatsink W 81HN UMA	5H40R33548	N				•
7	Fan W 81AX	5F10Q59964	N	•	•		
7	FAN W 81B4 Without Paint	5F10R28076	N			•	•
8	RAM, 4G DDR4 2400 SODIMM	01FR300	N	•	•		•
8	RAM, 8GB DDR4 2666 SoDIMM,MICRON	01AG812	N	•	•		•
8	RAM, 8GB DDR4 2666 SoDIMM,Ramaxel	01AG818	N	•	•		•
8	RAM, 16G DDR4 2400 SODIMM	01FR302	N	•	•		
8	RAM, 4GB DDR4 2400 SoDIMM	01AG708	N	•	•	•	•
8	RAM, 16GB DDR4 2666 SoDIMM,Ramaxel	01AG819	N	•	•		
8	RAM, 4GB DDR4 2400 SoDIMM	01AG709	N	•	•		•
8	RAM, 2GB DDR4 2400 SoDIMM,Hynix	01FR309	N	•	•		•
8	RAM, 8GB DDR4 2400 SoDIMM	01AG711	N	•	•		•
8	RAM, 8G DDR4 2400 SODIMM	01FR301	N	•	•		•
8	RAM, 16GB DDR4 2666 SoDIMM,MICRON	01AG813	N	•	•		
8	RAM, 2GB DDR4 2400 SoDIMM	01AG700	N	•	•		•
8	RAM, 2GB DDR4 2400 SoDIMM	01AG706	N	•	•		•
8	RAM, 4GB DDR4 2400 SoDIMM	01AG701	N	•	•	•	•
8	RAM, 16GB DDR4 2400 SoDIMM	01AG714	N	•	•		
8	RAM, 4GB DDR4 2666 SOIMM,Hynix	01AG823	N		•		•
8	RAM, 4GB DDR4 2400 SoDIMM,Samsung	01FR311	N		•		
8	RAM, 4GB DDR4 2666 SODIMM,Ramaxel	01AG829	N		•		•
8	RAM, 8GB DDR4 2666 SoDIMM,Ramaxel	01AG843	N			•	
8	RAM, 4GB DDR4 2666 SoDIMM,Micron	01AG831	N			•	
8	RAM, 4GB DDR4 2666 SoDIMM,Samsung	01AG836	N			•	
8	RAM, 8GB DDR4 2666 SoDIMM,Micron	01AG841	N			•	
8	RAM, 8GB DDR4 2666 SoIMM,Hynix	01AG824	N			•	
8	RAM, SODIMM,8GB, DDR4, 2666,SAMSUNG	01AG855	N			•	
9	SSD, Storage SSD AM6671 PCIe 512G	01FR501	N	•	•		•
9	SSD, SS MZVLW128HEGR 128G PCIE SSD	5SD0L73445	N	•	•		•

Lenovo V330-15ISK/Lenovo V330-15IKB/Lenovo V130-15IGM/ Lenovo V130-15IKB Hardware Maintenance Manual

Table 5. Parts list—Overall (continued)

No.	FRU	FRU no.	CRU ID.	Lenovo V330-15ISK	Lenovo V330-15IKB	Lenovo V130-15IGM	Lenovo V130-15IKB
9	SSD, Storage SSD PM981 PCIe 512G SAM	01FR511	N	•	•		•
9	SSD, Storage SSD XG5 512G PCIe TSB	01FR518	N	•	•		•
9	SSD, Storage SSD SC313 256G 2280 Hynix	01FR529	N	•	•		•
9	SSD, LIT CA1 128GB M.2 2280 PCIe SSD	5SDON04881	N	•	•		•
9	SSD, Storage SSD AM6671 PCIe 256G	01FR500	N	•	•		•
9	SSD, Storage SSD XG5 256G PCIe TSB	01FR517	N	•	•		•
9	SSD, SS MZVLW256HEHP 256G PCIE SSD	5SD0L73444	N	•	•		•
9	SSD, SS MZVLW512HMJP 512G PCIE SSD	5SD0L73443	N	•	•		•
9	SSD, Storage SSD SC313 128G 2280 Hynix	01FR528	N	•	•		•
9	SSD, Storage SSD PC401 256G M.2 Hynix	01FR537	N	•	•		•
9	SSD, Storage SSD PM871b 128G SAM	01FR505	N	•	•		•
9	SSD, Storage SSD PM871b 256G SAM	01FR506	N	•	•		•
9	SSD, Storage SSD SC313 256G Hynix	01FR515	N			•	
9	SSD, Storage SSD PM871b 256G SAM	01FR503	N			•	
9	SSD, Storage SSD 545s 256GB 2.5" Intel	01FR531	N			•	
9	SSD, Storage SSD SC313 128G Hynix	01FR514	N			•	
9	SSD, Storage SSD PM871b 128G SAM	01FR502	N			•	
10	WLAN, Wireless,CMB,LTN,NFA435A	01AX709	N	•	•	•	•
10	WLAN, Wireless,CMB,FXN,8822BE M2	01AX712	N	•	•		
10	WLAN, Wireless,CMB,IN,8265 NV M2	01AX704	N	•	•		
10	WLAN, Wireless,CMB,IN,3165 ac	00JT497	N	•	•	•	•
10	WLAN, Wireless,CMB,CBT,8821CE	01AX710	N			•	•
11	Battery, InterBty W 81HN W/Mylar39W India	5B10R38760	N	•			•
11	Battery, InternalBattery W81HNW/Mylar 39W	5B10R33563	N	•			•
11	Battery, InternalBattery W81B4 W/Mylar30W	5B10R32998	N	•	•	•	•
11	Battery, InterBty W 81HN W/Mylar30W India	5B10R38759	N	•	•		•
12	Speaker Twin W 81AX	5SB0Q60002	N	•	•	•	•
13	I/O Board W 81AX W/Cable	5C50Q59944	N	•	•		•
13	I/O Board W 81B4 W/Cable	5C50R28081	N			•	
14	ODD, HLDS GUEON DVD RW	5DX0J46488	*	•	•	•	•
14	ODD, PLDS DA-8AESH 9.0 mm ODD	5DX0L08424	*			•	
15	2nd Battery, V/E CP/C L17C2PB5 7.7V39Wh2cell bty	5B10P98182	*	•	•		
15	2nd Battery, CP/C L17C2PB4 7.7V39Wh2cell bty	5B10P53999	*		•		
15	2nd Battery, SP/A L17M2PB4 7.68V39Wh2cell bty	5B10P53995	*		•		
16	Dummy ODD W 81AX IG	5M20Q59973	*	•	•		
16	Dummy ODD W 81AX MG	5M20Q60053	*	•	•		
16	Dummy ODD W 81B4	5M20R28080	*			•	•
17	HDD, WD WD5000LPCX-24VHAT0	5H20J35762	N	•	•	•	•
17	HDD, Storage,HDD,1T,7200,7mm,SATA,ST	01FR405	N	•	•		•
17	HDD, ST Rosewood2D 7mm 2TB HDD	5H20M37521	N	•	•		•
17	HDD, ST YarraX 500G 7200 HDD	5H20K22136	N	•	•		•
17	HDD, WD MN500S-2 500G 7200 HDD	5H20L07579	N	•	•		•
17	HDD, RW1D ST1000LM035 1T HDD	5H20L22184	N	•	•	•	•
17	HDD, Storage,HDD,1T,5400,7mm,SATA,WD	01FR402	N	•	•	•	•

Table 5. Parts list—Overall (continued)

No.	FRU	FRU no.	CRU ID.	Lenovo V330-15ISK	Lenovo V330-15IKB	Lenovo V130-15IGM	Lenovo V130-15IKB
17	HDD, Toshiba MQ01ABF050 500G HDD	5H20L34560	N	●	●	●	●
17	HDD, Storage,HDD,500G,5400,7mm,ST	01FR401	N			●	
18	Lower Case W 81AX A W/Sponge IG	5CB0Q59988	N	●	●		
18	Lower Case W 81AX B W/Sponge IG	5CB0Q60184	N	●	●		
18	Lower Case W 81AX A W/Sponge MG	5CB0Q60114	N	●	●		
18	Lower Case W 81AX B W/Sponge MG	5CB0Q60109	N	●	●		
18	Lower Case W 81B4	5CB0R28075	N			●	
18	Lower Case W 81HN IG	5CB0R33568	N				●
19	FINGER_PRT W 81AX W/Cable IG	5F30Q60159	N	●	●		
19	FINGER_PRT W 81AX W/Cable MG	5F30Q60101	N	●	●		
—	AC adapter (see “AC adapters” on page 86).						

LCD FRUs

In Lenovo V330-15ISK/Lenovo V330-15IKB/Lenovo V130-15IGM/
Lenovo V130-15IKB, there are following types of LCDs.

- “15.6-in. HD/FHD LED”

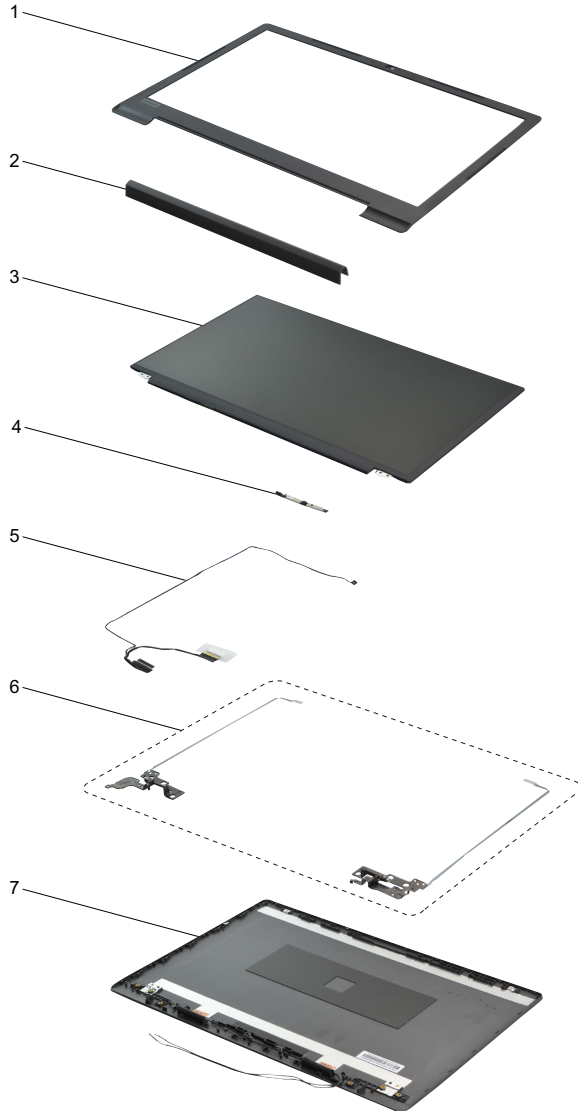


Table 6. Parts list—LCD FRUs

No.	FRU	FRU no.	CRU ID.	Lenovo V330-15ISK	Lenovo V330-15IKB	Lenovo V130-15IGM	Lenovo V130-15IKB
1	LCD Bezel W 81AX W/CCD	5B30Q60099	N	•	•	•	•
2	Hinge Cover W 81AX IG	5CB0Q60124	N	•	•	•	•
2	Hinge Cover W 81AX MG	5CB0Q60247	N	•	•		
3	Panel, IN N156HGA-EAB FHDT AG S NB	5D10K93435	N	•	•	•	•
3	Panel, AU B156HTN03.8 0C FHDT AG S NB	5D10L08702	N	•	•	•	•
3	Panel, AU B156XTN07.1 3A HDT AG S NB	5D10H52713	N	•	•	•	•
3	Panel, IN N156BGA-EA2 HDT AG S NB	5D10K81086	N	•	•	•	•
4	Camera, Comn Camera C 0.3M 1MIC Chy	01FR806	N	•	•	•	•
4	Camera, Comn Camera B HD720P 1MIC Chy	01FR801	N	•	•	•	•
4	Camera, Comn Camera C 0.3M 1MIC Bsn	01FR805	N	•	•	•	•
4	Camera, Comn Camera C 0.3M 1MIC Awa	01FR809	N	•	•	•	•
4	Camera,720P,Front,2MIC,WTB,Azw	01HW037	N	•	•		
4	Camera, Comn Camera B HD720P 1MIC Bsn	01FR800	N	•	•	•	•
4	Camera,720P,Front,2MIC,WTB,Bsn	01HW027	N	•	•		
4	Camera, Comn Camera B HD720P 1MIC Ltn	01FR802	N	•	•	•	•
4	Camera,720P,Front,2MIC,WTB,Chy	01HW028	N	•	•		
5	EDP Cable W 81AX W/CAM Cable	5C10Q60138	N	•	•	•	•
6	Hinge W 81AX R+L	5H50Q60131	N	•	•	•	•
7	LCD Cover W 81AX W/Antenna IG	5CB0Q60062	N	•	•	•	
7	LCD Cover W 81AX W/Antenna MG	5CB0Q60146	N	•	•		
7	LCD Cover W 81HL W/Antenna IG	5CB0R28213	N				•

Miscellaneous parts

Table 7. Parts list—Miscellaneous parts

FRU	P/N	CRU ID.	Lenovo V330-15ISK	Lenovo V330-15IKB	Lenovo V130-15IGM	Lenovo V130-15IKB
System miscellaneous parts:						
• (a) ODD hook W 81AX	5M20Q59946	*	•	•		
• (a) ODD Bracket W 81B4	5B40R28073	*			•	•
• (b) ODD Bezel W 81AX IG	5B30Q60207	*	•	•	•	•
• (b) ODD Bezel W 81AX MG	5B30Q60105	*	•	•		
• (c) 2ND Battery Bezel W 81AX IG	5B30Q60102	*	•	•		
• (c) 2ND Battery Bezel W 81AX MG	5B30Q60058	*	•	•		
• (d) HDD Bracket W 81AX	5B40Q60004	N	•	•	•	•
• (e) FP Bracket W 81AX	5B40Q59949	N	•	•		
Cable miscellaneous parts:						
• (f) DC-IN Cable W 81AX	5C10Q60249	N	•	•	•	•
• (g) HDD Cable W 81AX	5C10Q59981	N	•	•	•	•
Note: Italicized letters in parentheses are references to the exploded view in “Overall” on page 72.						

AC adapters

Table 8. Parts list—AC adapters

FRU	P/N	CRU ID.	Lenovo V330-15ISK	Lenovo V330-15IKB	Lenovo V130-15IGM	Lenovo V130-15IKB
ADLX65NDC3A 20V3.25A COO	01FR039	*	•	•		•
ADLX65NCC3A 20V3.25A COO	01FR050	*	•	•		•
ADLX65NLC3A 20V3.25A AD BIS	5A10J75114	*	•	•		•
ADLX45DLC3A 20V2.25A COO	01FR035	*	•	•	•	•
ADLX45NCC3A 20V2.25A COO	01FR047	*	•	•	•	•
ADLX45NDC3A 20V2.25A COO	01FR038	*	•	•	•	•
ADLX45NAC3A 20V2.25A COO	01FR053	*	•	•	•	•

Screws

Table 9. Parts list—Screws

FRU	P/N	CRU ID.	Lenovo V330-15ISK	Lenovo V330-15IKB	Lenovo V130-15IGM	Lenovo V130-15IKB
Screw Pack W 81AX	5S10Q60115	N	•	•		
Screw Pack W 81B4	5S10R32775	N			•	•

Power cords

A Lenovo power cord for a specific country or region is usually available only in that country or region:

Table 10. Parts list—3-pin power cords

Region	P/N	CRU ID.	Lenovo V330-15ISK	Lenovo V330-15IKB	Lenovo V130-15IGM	Lenovo V130-15IKB
UK 3pin • LINETEK LP-61L+ H03VV-F+ LS15 1m	145000593	*	•	•		
UK 3pin • Longwell LP-61L+H03VV-F+LS-18 1m	145000561	*	•	•	•	•
UK 3pin • VOLEX MP5004+H03VV-F+VAC5S 1m	145000605	*	•	•	•	•
UK 3pin • lux 0031+H03VV-F 0.75/3C+0011 1m	145500000	*	•	•	•	•
Europe 3pin • LINETEK LP-34+H03VV-F + LS15 1m	145000585	*	•	•		
Europe 3pin • Longwell LP-34A+H03VV-F+LS-18 1m	145000553	*	•	•	•	•
Europe 3pin • VOLEX M2511+HO3VV-F+VAC5S 1m	145000525	*	•	•	•	•
Europe 3pin • lux 0033+H03VV-F 0.75/3C+0011 1m	145500001	*	•	•	•	•
US 3pin • LINETEK LP-30B + SPT-2 + LS15 1m	145000594	*	•	•		
US 3pin • Longwell LP-30B+SPT-2 18AWG+LS-18 1m	145000562	*	•	•	•	•
US 3pin • Volex US15S3+SPT-2+VAC5S 1m	145000537	*	•	•	•	•
US 3pin • lux 0014+SPT-2 60°C 18/3C+0016 1m	145500002	*	•	•	•	•
China 3pin • LINETEK PC323+RVV300/300+LS15 1m	145000600	*	•	•		
China 3pin • Longwell LSG-31+RVV300/300+LS-18 1m	145000568	*	•	•	•	•
China 3pin • VOLEX GB10S3+RVV 300/500+VAC5S 1m	145000538	*	•	•	•	•
China 3pin • lux 0036+RVV 300/300 0.75/3C+0002 1m	145500003	*	•	•	•	•
India 3pin • LINETEK PE-361+ H05VV-F+ LS15 1m	145000592	*	•	•		
India 3pin • Longwell LP-67+BIS+LS-18 1m	145000560	*	•	•	•	•
India 3pin • VOLEX IA6A3+IS694+VAC5S 1m	145000536	*	•	•		
India 3pin • lux 0046+IS694 0.75/3C+0011 1m	145500004	*	•	•	•	•
Japan 3pin • LINETEK LS15+VCTF+LP-54 1m	145000587	*	•	•		

Lenovo V330-15ISK/Lenovo V330-15IKB/Lenovo V130-15IGM/ Lenovo V130-15IKB Hardware Maintenance Manual

Table 10. Parts list—3-pin power cords (continued)

Region	P/N	CRU ID.	Lenovo V330-15ISK	Lenovo V330-15IKB	Lenovo V130-15IGM	Lenovo V130-15IKB
Japan 3pin • Longwell LP-54+VCTF+LS-18 1m	145000555	*	•	•	•	•
Japan 3pin • VOLEX VAC5S+VCTF+M755 1m	145000530	*	•	•	•	•
Japan 3pin • lux 0018(E)+VCTF 0.75/3C+0021 1m	145500005	*	•	•	•	•
Australia 3pin • LINETEK LS15+H03VV-F+LP-23A 1m	145000589	*	•	•		
Australia 3pin • Longwell LP-23A+LFC-3R+LS-18 1m	145000557	*	•	•	•	•
Australia 3pin • VOLEX AU10S3+H03VV-F+VAC5S 1m	145000532	*	•	•	•	•
Australia 3pin • lux 0038+H03VV-F 0.75/3C+0011 1m	145500006	*	•	•	•	•
Taiwan 3pin • Linetek Taiwan C5 3pin	SL60M91981	*	•	•		
Taiwan 3pin • Longwell LP-71+VCTF+LS-33 1m	SL60P41024	*	•	•	•	•
Taiwan 3pin • VOLEX TW15CS3+VCTF+VAC5S 1m	SL60P41028	*	•	•	•	•
Taiwan 3pin • lux 0019+VCTF 0.75/3C+0021 1m	SL60P41026	*	•	•	•	•
Korea 3pin • LINETEK LS15+H05VV-F+LP-E04A 1m	145000590	*	•	•		
Korea 3pin • Longwell LP-486+KTLH03VV-F+LS-5 1m	145000558	*	•	•	•	•
Korea 3pin • VOLEX M2511+KETI IEC+VAC5S 1m	145000533	*	•	•	•	•
Korea 3pin • lux 0033+H03VV-F 0.75/3C+0011 1m	145500008	*	•	•	•	•
Italy 3pin • LINETEK LS15+H03VV-F+PE-336 1m	145000591	*	•	•		
Italy 3pin • Longwell LP-22+H03VV-F+LS-18 1m	145000559	*	•	•	•	•
Italy 3pin • VOLEX IT10S3+H03VV-F+VAC5S 1m	145000535	*	•	•	•	•
Italy 3pin • lux 0029+H03VV-F 0.75/3C+0011 1m	145500009	*	•	•	•	•
South Africa 3pin • LINETEK LS15+H03VV-F+PE-364 1m	145000586	*	•	•		
South Africa 3pin • Longwell LP-39+H03VV-F+LS-18 1m	145000554	*	•	•	•	•
South Africa 3pin • lux 0044+H03VV-F 0.75/3C+0011 1m	145500010	*	•	•	•	•

Table 10. Parts list—3-pin power cords (continued)

Region	P/N	CRU ID.	Lenovo V330-15ISK	Lenovo V330-15IKB	Lenovo V130-15IGM	Lenovo V130-15IKB
Brazil 3pin • LINETEK LS15 H03VV-F LP26A 1m	145000596	*	•	•		
Brazil 3pin • Longwell LP-46+H03VV-F+LS-18 1m	145000564	*	•	•	•	•
Brazil 3pin • VOLEX CH10S3+H03VV-F+VAC5S 1m	145000527	*	•	•	•	•
Brazil 3pin • lux 0034+H03VV-F 0.75/3C+0011 1m	145500011	*	•	•	•	•
Israel 3pin • LINETEK LS15+H03VV-F+LP-41 1m	145000595	*	•	•		
Israel 3pin • Longwell LP-41+H03VV-F+LS-18 1m	145000563	*	•	•	•	•
Israel 3pin • VOLEX SI16S3+H03VV-F+VAC5S 1m	145000526	*	•	•	•	•
Israel 3pin • lux 0041+H03VV-F 0.75/3C+0011 1m	145500012	*	•	•	•	•
Switzerland 3pin • LINETEK LS15+H03VV-F+LP-37 1m	145000597	*	•	•		
Switzerland 3pin • Longwell LP-37+H03VV-F+LS-18 1m	145000565	*	•	•	•	•
Switzerland 3pin • VOLEX MP232+H03VV-F+VAC5S 1m	145000524	*	•	•	•	•
Switzerland 3pin • lux 0027+H03VV-F 0.75/3C+0011 1m	145500013	*	•	•	•	•
Denmark 3pin • LINETEK LS15+H03VV-F+LP-38 1m	145000598	*	•	•		
Denmark 3pin • Longwell LP-40+H03VV-F+LS-18 1m	145000566	*	•	•		
Denmark 3pin • VOLEX MP233D+H03VV-F+VAC5S 1m	145000534	*	•	•		
Denmark 3pin • lux 0048+H03VV-F 0.75/3C+0011 1m	145500014	*	•	•		
Thailand 3pin • lux 0014+H03VV-F 0.75/3C+0011 1m	5L60J33143	*	•	•	•	•
Argentina 3pin • LINETEK LS15+H03VV-F+LP39 1m	145000599	*	•	•		
Argentina 3pin • Longwell LP-24+H03VV-F+LS-18 1m	145000567	*	•	•	•	•
Argentina 3pin • VOLEX VA2073+H03VV-F+VAC5S 1m	145000528	*	•	•	•	•
Argentina 3pin • lux 0040+H03VV-F 0.75/3C+0011 1m	145500015	*	•	•	•	•

Notices

Lenovo may not offer the products, services, or features discussed in this document in all countries. Consult your local Lenovo representative for information on the products and services currently available in your area. Any reference to a Lenovo product, program, or service is not intended to state or imply that only that Lenovo product, program, or service may be used. Any functionally equivalent product, program, or service that does not infringe any Lenovo intellectual property right may be used instead. However, it is the user's responsibility to evaluate and verify the operation of any other product, program, or service.

Lenovo may have patents or pending patent applications covering subject matter described in this document. The furnishing of this document does not give you any license to these patents.

LENOVO GROUP LTD. PROVIDES THIS PUBLICATION "AS IS" WITHOUT WARRANTY OF ANY KIND, EITHER EXPRESS OR IMPLIED, INCLUDING, BUT NOT LIMITED TO, THE IMPLIED WARRANTIES OF NON-INFRINGEMENT, MERCHANTABILITY OR FITNESS FOR A PARTICULAR PURPOSE. Some jurisdictions do not allow disclaimer of express or implied warranties in certain transactions, therefore, this statement may not apply to you.

This information could include technical inaccuracies or typographical errors. Changes are periodically made to the information herein; these changes will be incorporated in new editions of the publication. Lenovo may make improvements and/or changes in the product(s) and/or the program(s) described in this publication at any time without notice.

The products described in this document are not intended for use in implantation or other life support applications where malfunction may result in injury or death to persons. The information contained in this document does not affect or change Lenovo product specifications or warranties. Nothing in this document shall operate as an express or implied license or indemnity under the intellectual property rights of Lenovo or third parties. All information contained in this document was obtained in specific environments and is presented as an illustration. The result obtained in other operating environments may vary.

Lenovo may use or distribute any of the information you supply in any way it believes appropriate without incurring any obligation to you.

Any references in this publication to non-Lenovo Web sites are provided for convenience only and do not in any manner serve as an endorsement of those Web sites. The materials at those Web sites are not part of the materials for this Lenovo product, and use of those Web sites is at your own risk.

Any performance data contained herein was determined in a controlled environment. Therefore, the result obtained in other operating environments may vary significantly. Some measurements may have been made on development-level systems and there is no guarantee that these measurements will be the same on generally available systems. Furthermore, some measurements may have been estimated through extrapolation. Actual results may vary. Users of this document should verify the applicable data for their specific environment.

Trademarks

Lenovo is a trademark or registered trademark of Lenovo in the United States, other countries, or both.

Microsoft and Windows are trademarks of Microsoft Corporation in the United States, other countries, or both.

Other company, products, or service names may be trademarks or service marks of others.