

USER MANUAL

DCS-6616

VERSION 1.0



D-Link[®]

SURVEILLANCE

Table of Contents

Product Overview	3	Recording	45
Package Contents	3	Advanced.....	46
System Requirements	3	DI and DO (Digital Input/Output).....	46
Introduction	4	ICR.....	47
Features	4	HTTPS	48
Resetting the Camera.....	5	Access List.....	49
Mount Instructions	6	Maintenance	50
D-ViewCam Device Pack Setup	17	Admin.....	50
Live Video	18	Backup and Restore	51
Setup	21	Firmware Upgrade	52
Internet Connection Setup Wizard.....	21	Status	53
Motion Detection Setup Wizard	24	Device Info.....	53
Network Setup	26	Logs	54
Dynamic DNS	28	Help	55
Image Setup	29	DI/DO Configuration	56
Audio and Video	31	DI/DO Pin Block Specifications	56
PTZ Setup.....	32	Digital Input Diagram	57
Preset	34	Digital Output Diagram	58
Motion Detection.....	36	Technical Specifications	59
Time and Date	37		
Event Setup	38		
Application	39		
Add Server.....	40		
Add Media.....	41		
Add Event	44		

Preface

D-Link reserves the right to revise this publication and to make changes in the contents hereof without obligation to notify any person or organization of such revisions or changes.

Manual Revisions

Revision	Date	Description
1.0	July 22, 2011	DCS-6616 Revision A1 with firmware version 2.00

Trademarks

D-Link and the D-Link logo are trademarks or registered trademarks of D-Link Corporation or its subsidiaries in the United States or other countries. All other company or product names mentioned herein are trademarks or registered trademarks of their respective companies.

Copyright © 2010-2011 by D-Link Systems, Inc.

All rights reserved. This publication may not be reproduced, in whole or in part, without prior expressed written permission from D-Link Systems, Inc.

Package Contents

- DCS-6616 High Speed Dome Network Camera
- Data Cable for Video, Audio, Alarm, and Power
- Power Adapter
- Power Cable
- Optical Cover
- Manual and Software on CD
- Quick Installation Guide
- Screws
- Mounting Bracket and Screws

If any of the above items are missing, please contact your reseller.

System Requirements

- CPU: Pentium 4 1.4GHz or above
- Hard Disk: 40GB or above
- Memory: 256MB or above
- Browser: Internet Explorer 6.0 or above
- Video Resolution: SVGA or XGA (1024x768 or above)

Introduction

The DCS-6616 Speed Dome Network Camera is a professional IP surveillance solution which connect to your network to provide high-quality live video over the Internet. The camera apparatus supports precise high-speed pan/tilt/zoom functionality for extensive monitoring, and object tracking.

Hardware Overview

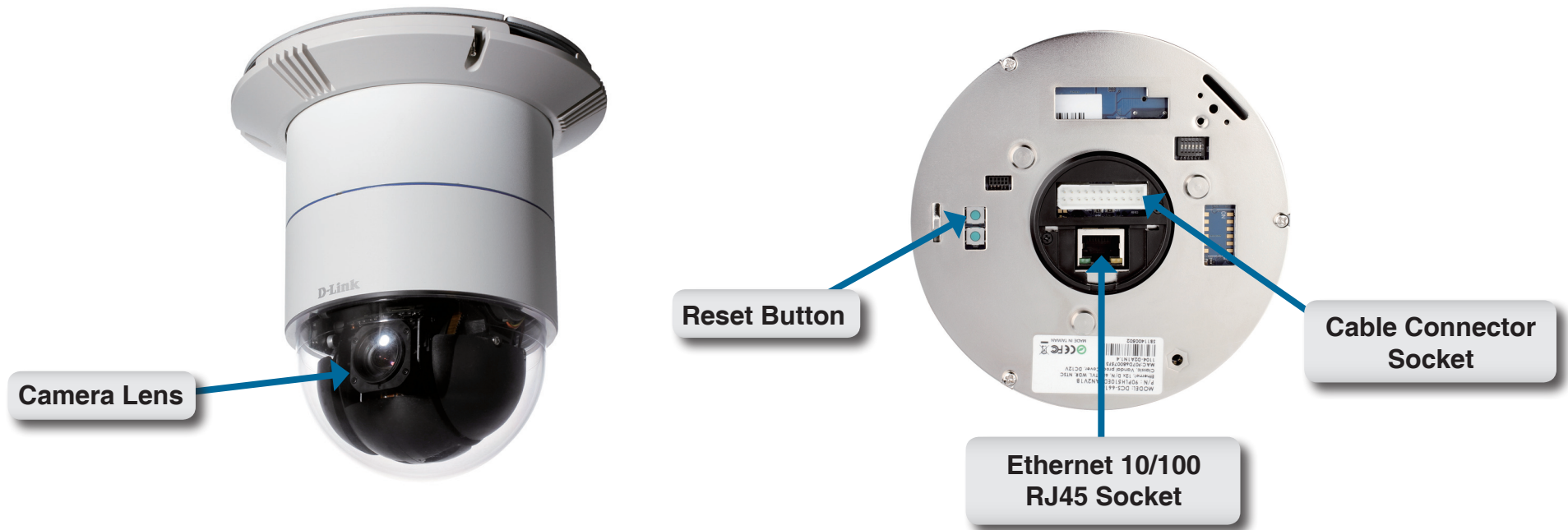

Resetting the Camera

The DCS-6616 contains both digital and mechanical components. Thus, if any problems are experienced with the camera, there are two different reset options depending on the type of problem.

Mechanical Reset

If the mechanical PTZ controls ever stop responding or seem to be locked up, you may reset the mechanical portion of the camera using the communication pin array at the base of the device.

1. Use a small tool to move switch 5 to the “off” position.
2. Plug the camera in for one minute and allow the device to initialize.
3. Return the pin back to its original “on” position.
4. Plug in the camera, and the device should successfully initialize.

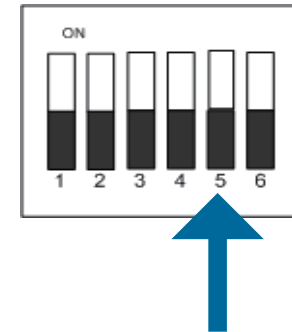

Digital Reset

If the camera’s web user interface ever becomes unresponsive, or if the administrator password is forgotten, it may become necessary to reset the device firmware to its original factory settings.

1. Press and hold the green button on the base of the camera for 10 seconds.
2. Allow a few minutes for the camera to re-initialize factory default settings.

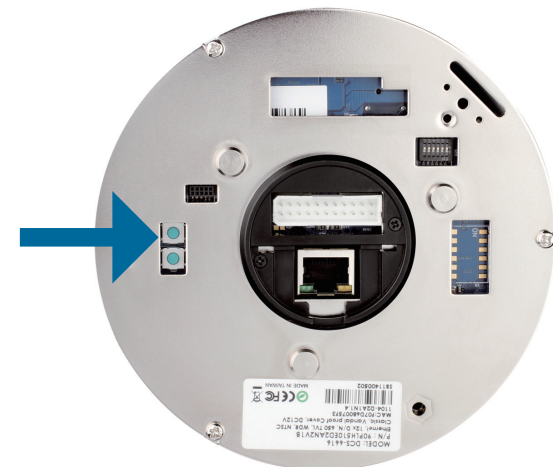

Mount Instructions

Detach the Decoration Ring from the Hard Ceiling Mount Bracket.

Align the three holes on the Mount Bracket, mark the screws locations on the ceiling.

Drill three pilot holes into the ceiling and hammer the plastic anchors into the holes.

Fix the Mount Bracket with three screws

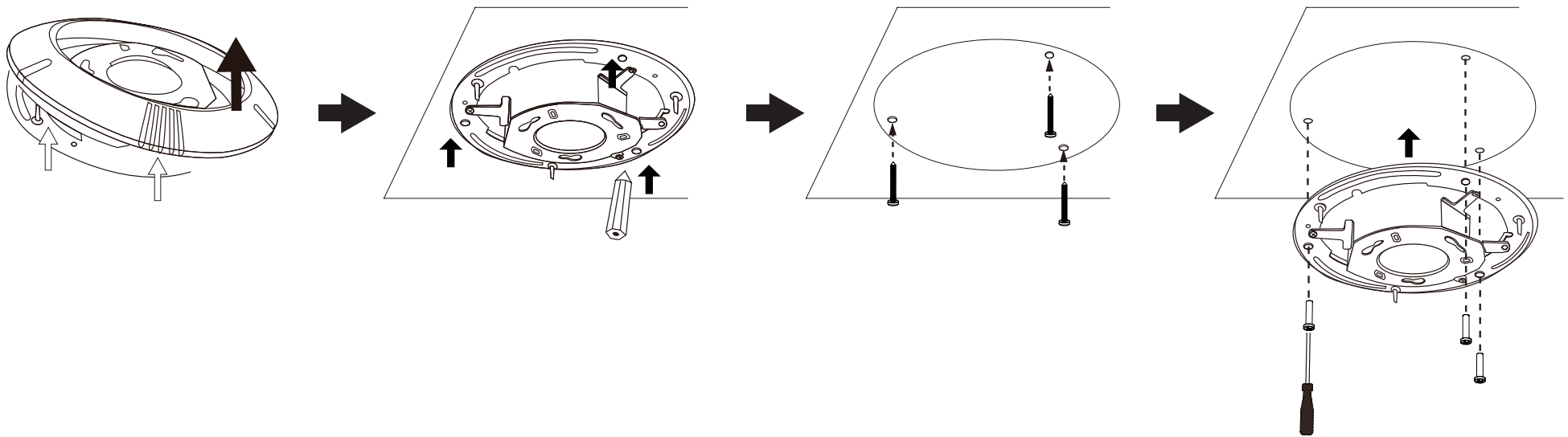

Insert the fixing plate into the groove as shown below.

Align the three holes to screw the fixing plate to the dome base.

Connect the cable connector and Ethernet cable to the dome base.

Align plate A and plate B, then use those three hole to hook the Network Camera on the ceiling mount bracket.

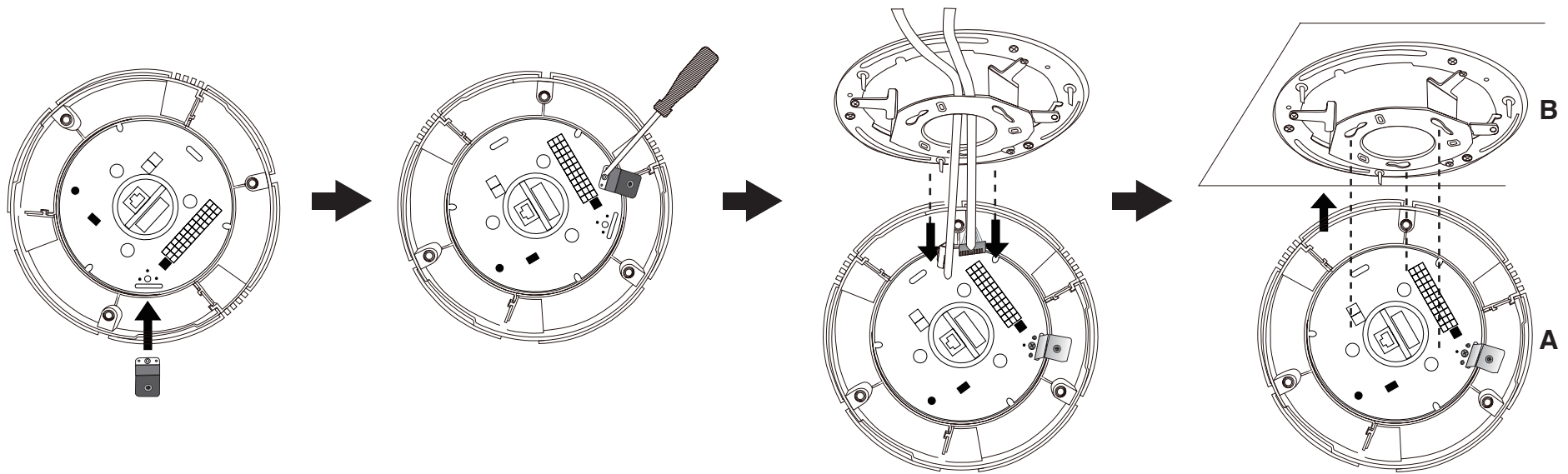

Tighten the screw on the fixing plat.

Align the three holes to mount the decoration ring.

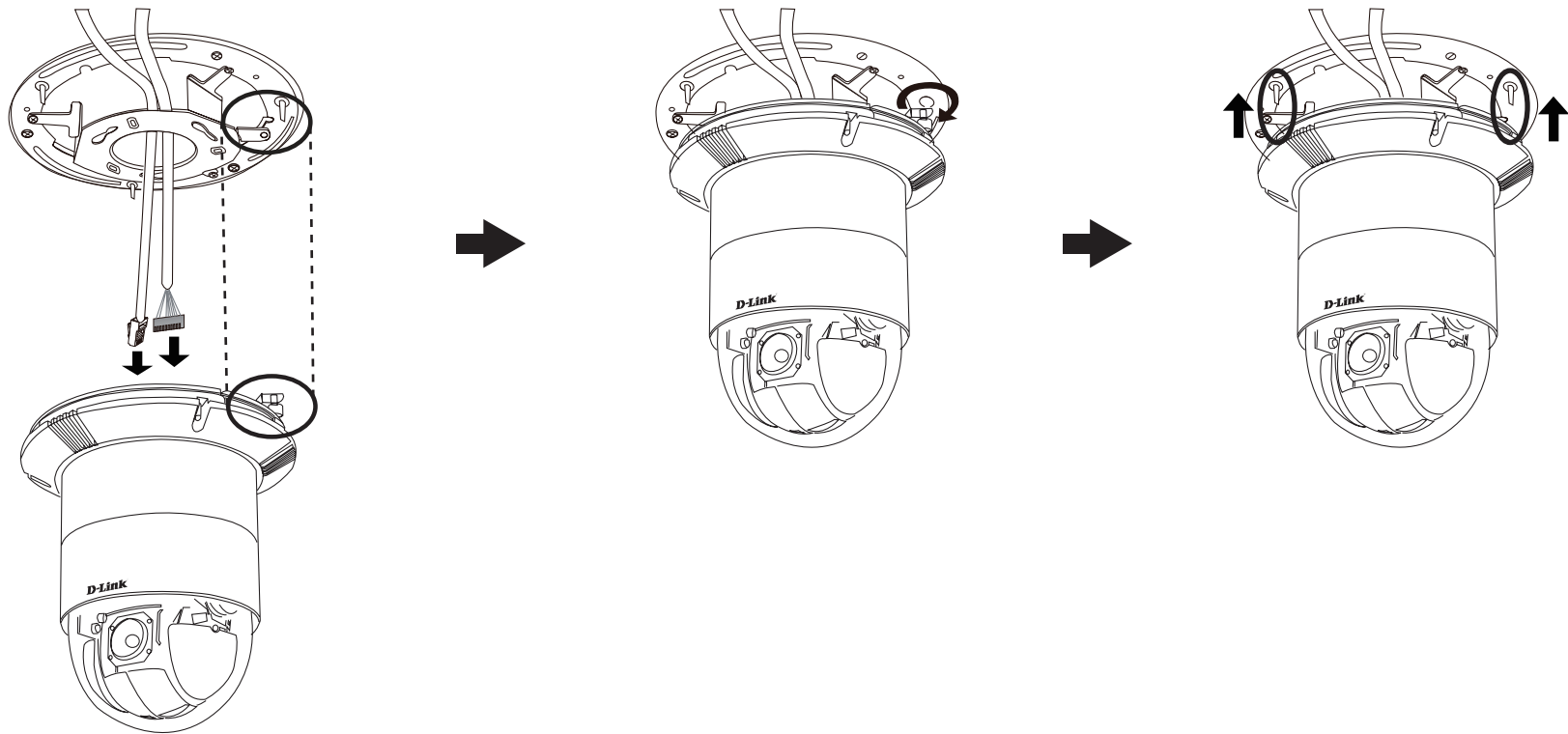

Configuration with Wizard

Insert the DCS-6616 CD into your computer's CD-ROM drive to begin the installation. If the Autorun function on your computer is disabled, or if the D-Link Launcher fails to start automatically, click **Start > Run**. Type **D:\autorun.exe**, where D: represents the drive letter of your CD-ROM drive.

Click **Setup Wizard** to begin the installation.



Click **Next** to continue.

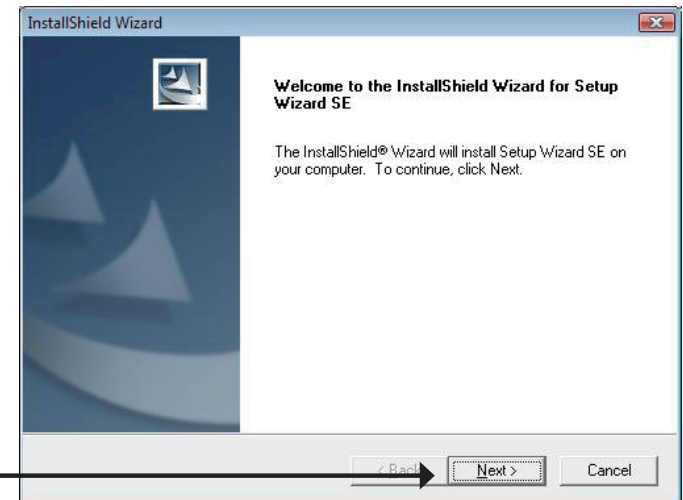

Click **Yes** to accept the License Agreement.

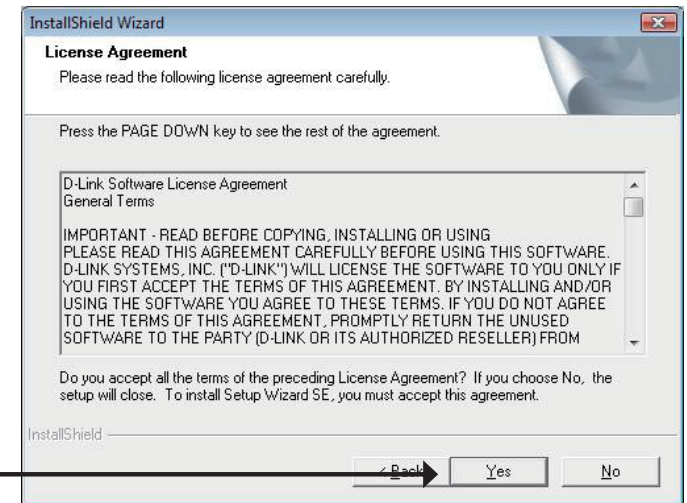

To start the installation process, click **Next**.

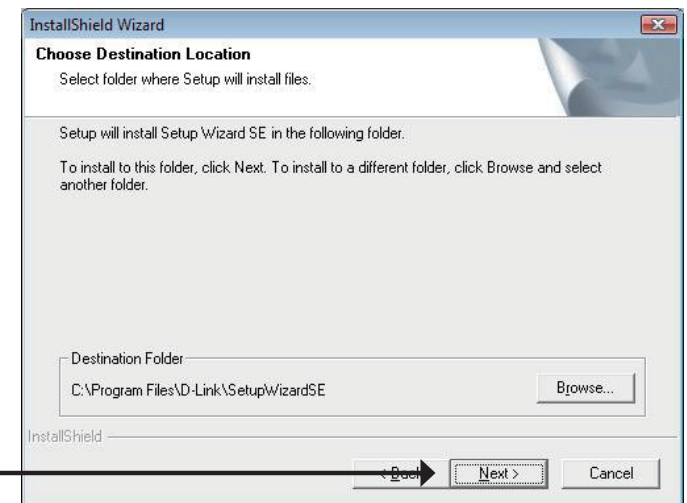

Note: The installation may take several minutes to finish.

Click **Finish** to complete the installation.

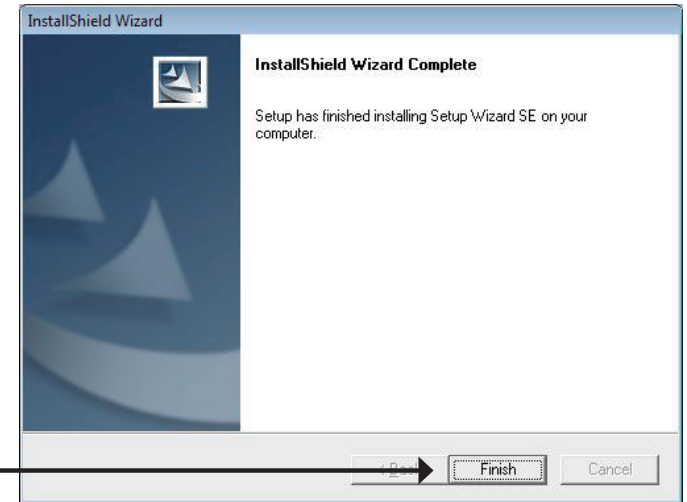

Click on the **D-Link Setup Wizard SE** icon that was created in your Windows Start menu.

Start > D-Link > Setup Wizard SE

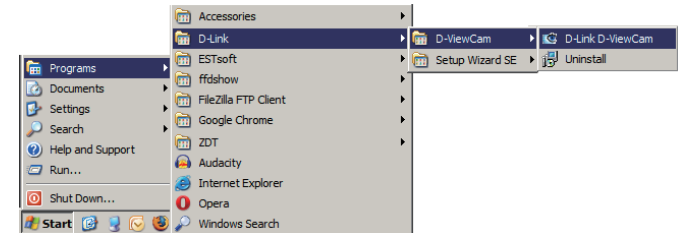

The Setup Wizard will appear and display the MAC address and IP address of your camera(s). If you have a DHCP server on your network, a valid IP Address will be displayed. If your network does not use a DHCP server, the network camera's default static IP address **192.168.0.20** will be displayed.

Click the **Wizard** button to continue.



Enter the Admin ID and password. When logging in for the first time, the default Admin ID is **admin** with the password left blank.

Click **Next**, to proceed to the next page.



Select **DHCP** if your camera obtains an IP address automatically when it boots up. Select **Static IP** if the camera will use the same IP address each time it is started.

Click **Next**, to proceed to the next page.

D-Link Building Networks for People

SECURICAM Network

Set IP Address

DHCP

Static IP

IP Address

Subnet Mask

Default Gateway

Primary DNS

Secondary DNS

Take a moment to confirm your settings and click **Restart**.

D-Link Building Networks for People

SECURICAM Network

Admin ID

Password

IP Address

Subnet Mask

Primary DNS

Secondary DNS

The Setup Wizard has completed. Click on 'Back' to modify your settings. Click 'Restart' to save your current settings and reboot the Internet Camera.

Web-based Configuration Utility

This section explains how to configure your new D-Link Network Camera using the Web-based Configuration Utility.

Click on the **D-Link Setup Wizard SE** icon that was created in your Windows Start menu.

Start > D-Link > Setup Wizard SE

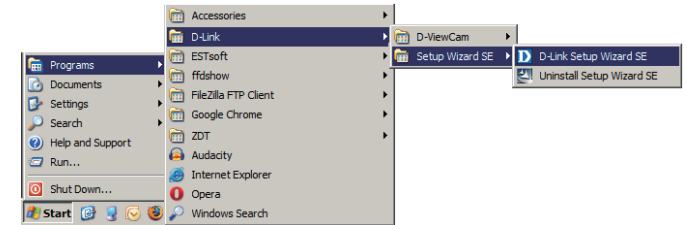

Select the camera and click the button labeled "**Link**" to access the web configuration.

The Setup Wizard will automatically open your web browser to the IP address of the camera.



Alternatively, you may manually open a browser and enter the IP address of the camera: **192.168.0.20**

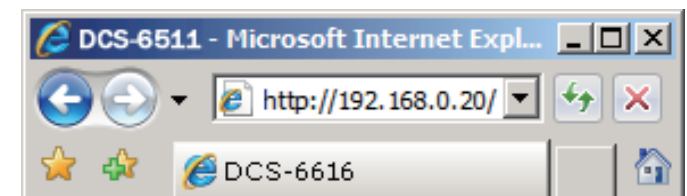

Enter **admin** as the default username and leave the password blank. Click **OK** to continue.

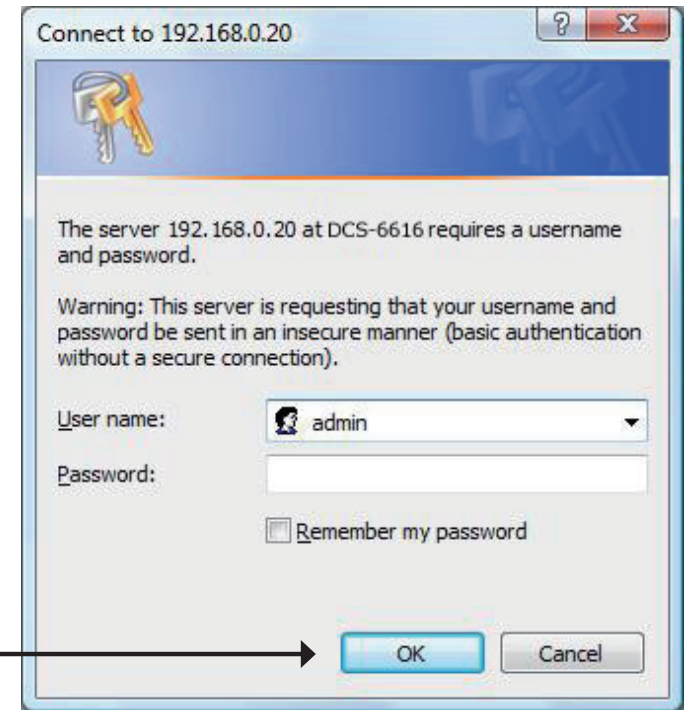

This section shows your camera's live video. You can select your video profile and view or operate the camera. For additional information about web configuration, please refer to the user manual included on the CD-ROM or the D-Link website.



D-ViewCam Setup Wizard

D-ViewCam software is included for the administrator to manage multiple D-Link IP cameras remotely. You may use the software to configure all the advanced settings for your cameras. D-ViewCam is a comprehensive management tool for IP surveillance.

Insert the CD-ROM into the CD-ROM drive. Click "Install D-ViewCam Software" from menu, and select "D-ViewCam" to install the VMS software.

Follow the Installation Wizard to install D-ViewCam.

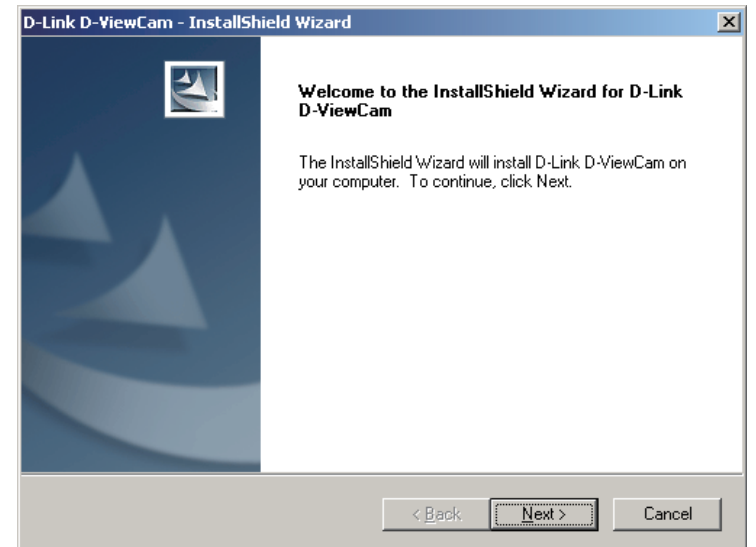

Click **Finish** to complete the installation.

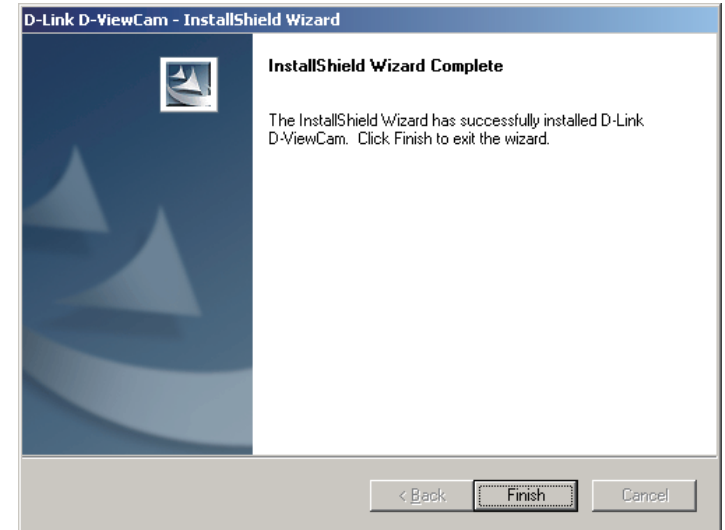

To start D-ViewCam, select **Start > All Programs > D-Link D-ViewCam > Main Console**.

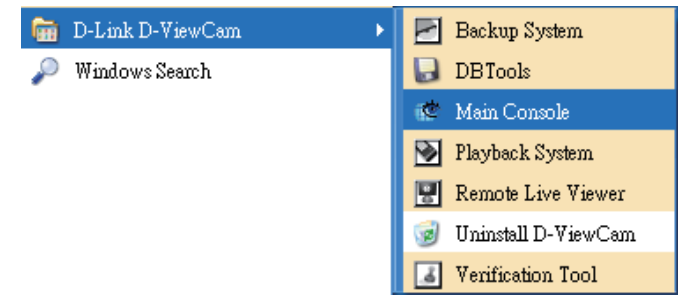

For more detail operation of using D-ViewCam software, please refer to D-ViewCam Manual.

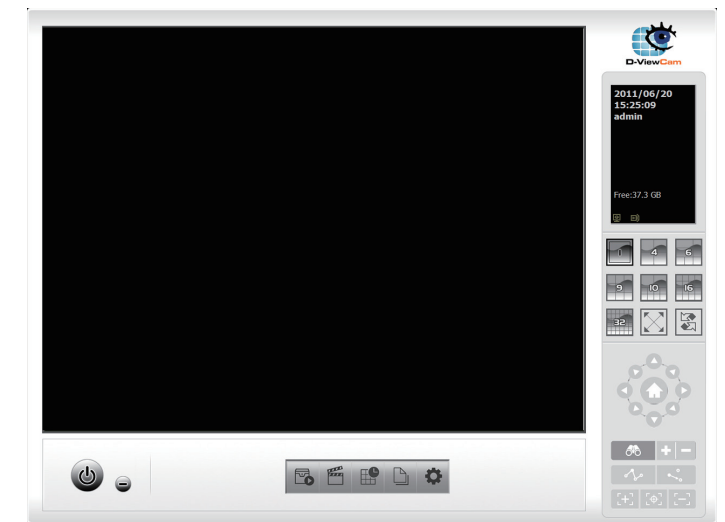

Live Video

This page displays live video and allows you to adjust and save camera images.

On-screen Display (OSD): The date, time, and camera name are displayed at the top left corner of the live video display.



Digital Input Indicators (1-8): These indicators blink when digital input is received.



Motion Trigger Indicator: This indicator blinks when motion is detected.



Recording Indicator: This indicator blinks when the camera is recording.

Navigation Pad: The navigation pad is used to carry out pan, tilt, and zoom functions. The camera can be aimed and the image adjusted using this pad.
(Up/Down/Left/Right/Home Zoom In/Zoom Out)

Note: The **Home** position of the dome camera not configured by default. Please see page 35 for information about how to configure the home position.

Pan Speed: There are 16 speeds for pan control. 1 is the slowest and 16 is the fastest.

Tilt Speed: There are 16 speeds for pan control. 1 is the slowest and 16 is the fastest.





AutoPan: Starts a pre-defined AutoPan movement. Select the number corresponding a predefined path.



Sequence: Starts a pre-defined sequence movement. Select the number corresponding a predefined path.



Cruise: Starts a pre-defined cruise movement. Select the number corresponding a predefined path.



Autofocus (AF): Click this button to enable automatic focus.



Manual Focus (MF): Click this button to manually focus the camera image.



Focus: Use these controls to focus the camera image.

Language: You may select **English** or **Traditional Chinese**.



Fullscreen: Loads the live camera image in fullscreen.



Snapshot: Saves a snapshot of the image to the specified location.



Start/Stop Recording: Begins recording to the specified location. Pressing this button a second time will stop the recording.



Set Storage Folder: Designates a folder where snapshots and video will be saved.





Start/Stop Digital Output: Sends a signal to the attached digital device.





Profile 1-3: Select one of three predefined video profiles to display in the Live Video window.

 **Start/Stop Listening:** Click this button to begin listening to the audio feed from a microphone connected to the camera (audio in).

 **Start/Stop Talking:** Click this button to begin sending audio to speakers connected to the camera (audio out).

GoTo

Go To (Preset): Selecting a preset from this list will load the preset in the Live Video windows.

Setup

To configure your Network Camera, click **Internet Connection Setup Wizard**. Alternatively, you may click **Manual Internet Connection Setup** to manually configure your Network Camera and skip to page 27.

To quickly configure your Network Camera's motion detection settings, click **Motion Detection Setup Wizard**. If you want to enter your settings without running the wizard, click **Manual Motion Detection Setup** and skip to page 37.

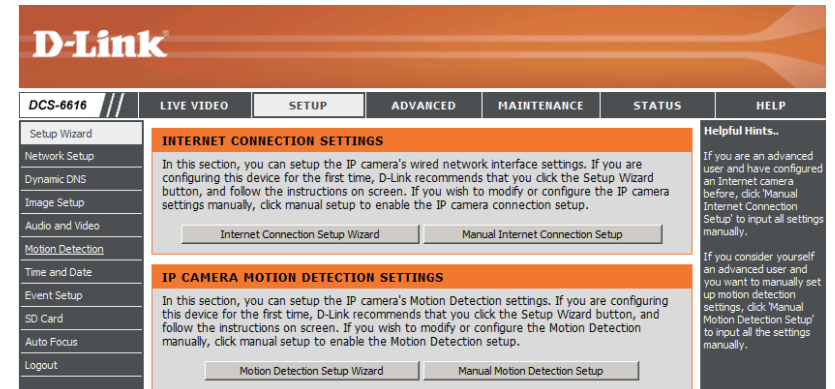

Internet Connection Setup Wizard

This wizard will guide you through a step-by-step process to configure your new D-Link Camera and connect the camera to the internet. Click **Next** to continue.

Note: Select DHCP if you are unsure of which settings to choose.

Click **Next** to continue.

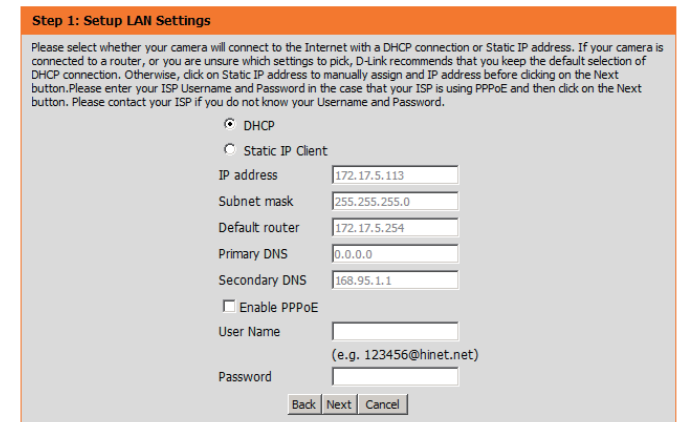
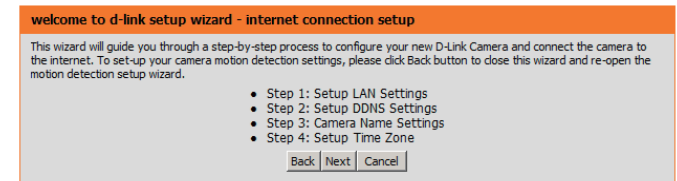

Select **Static IP** if your Internet Service Provider has provided you with connection settings, or if you wish to set a static address within your home network. Enter the correct configuration information and click **Next** to continue.

If you are using PPPoE, select **Enable PPPoE** and enter your user name and password, otherwise click **Next** to continue.

If you have a Dynamic DNS account and would like the camera to update your IP address automatically, Select **Enable DDNS** and enter your host information. Click **Next** to continue.

Enter a name for your camera and click **Next** to continue.

Step 1: Setup LAN Settings

Please select whether your camera will connect to the Internet with a DHCP connection or Static IP address. If your camera is connected to a router, or you are unsure which settings to pick, D-Link recommends that you keep the default selection of DHCP connection. Otherwise, click on Static IP address to manually assign and IP address before clicking on the Next button. Please enter your ISP Username and Password in the case that your ISP is using PPPoE and then click on the Next button. Please contact your ISP if you do not know your Username and Password.

DHCP
 Static IP Client

IP address
Subnet mask
Default router
Primary DNS
Secondary DNS

Enable PPPoE
User Name
(e.g. 123456@hinet.net)
Password

Step 2: Setup DDNS Settings

If you have a Dynamic DNS account and would like the camera to update your IP address automatically, enable DDNS and enter in your host information below. Please click on the Next button to continue.

Enable DDNS

Server Address <<

Host Name
User Name
Password
Verify Password
Timeout (hours)

Step 3: Camera Name Settings

D-Link recommends that you rename your camera for easy accessibility. You can then identify and connect to your camera via this name. Please assign a name of your choice before clicking on the Next button.

IP Camera Name

Configure the correct time to ensure that all events will be triggered as scheduled. Click **Next** to continue.

If you have selected DHCP, you will see a summary of your settings, including the camera's IP address. Please write down all of this information as you will need it in order to access your camera.

Click **Apply** to save your settings.

Step 4: Setup Time Zone

Please configure the correct time to ensure that all events are triggered, captured and scheduled at the correct time and day and then click on the Next button.

Time Zone

Enable Daylight Saving

Step 5: Setup complete

Below is a summary of your camera settings. Click on the Back button to review or modify settings or click on the Apply button if all settings are correct. It is recommended to note down these settings in order to access your camera on the network or via your web browser.

IP Address	DHCP
IP Camera Name	DCS-6616
Time Zone	(GMT+08:00) Taipei
DDNS	Disable
PPPoE	Disable

Motion Detection Setup Wizard

This wizard will guide you through a step-by-step process to configure your camera's motion detection functions.

Click **Next** to continue.

Step 1

This step will allow you to enable or disable motion detection, specify the detection sensitivity, and adjust the camera's ability to detect movement.

You may specify whether the camera should capture a snapshot or a video clip when motion is detected.

Please see the **Motion Detection** section on page 43 for information about how to configure motion detection.

Step 2

This step allows you to enable motion detection based on a customized schedule. Specify the day and hours. You may also choose to always record motion.

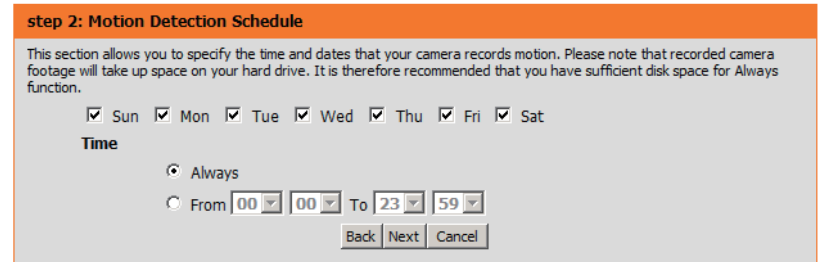
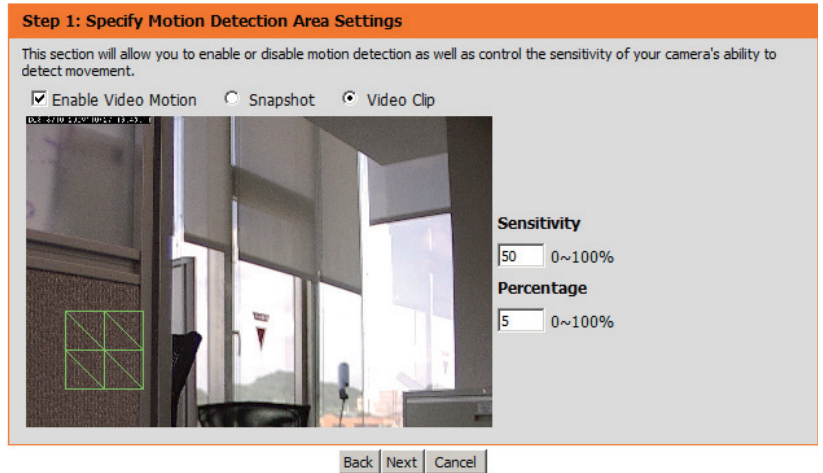
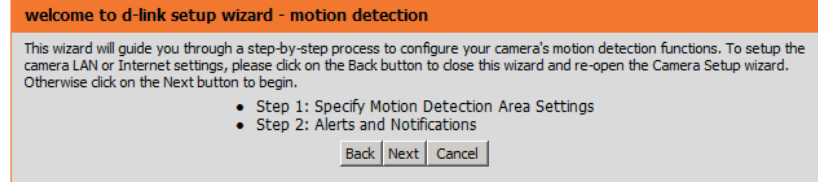

Step 3

This step allows you to specify how you will receive event notifications from your camera. You may choose not to receive notifications, or to receive notifications via e-mail or FTP.

Please enter the relevant information for your e-mail or FTP account.

Click **Next** to continue.

Step 3: Alerts and Notification

This final step allows you to specify how you receive notification of camera events. Choose between an email notification or alternatively you can setup an FTP Notification. You will need your email account settings or FTP details. If you are unsure of this information, please contact your ISP. Once you have entered this information, please click on the Next button.

Do not notify me

Email

Sender email address

Recipient email address

Server address

User name

Password

Port

FTP

Server address

Port

User name

Password

Remote folder name

Step 4

You have completed the Motion Detection Wizard.

Please verify your settings and click **Apply** to save them.

Step 4: Setup Complete

You have completed your camera setup. Please click the Back button if you want to review or modify your settings or click on the Apply button to save and apply your settings.

Motion Detection : Enable

EVENT : Video Clip

Schedule Day : Sun , Mon , Tue , Wed , Thu , Fri , Sat ,

Schedule Time : Always

Alerts and Notification : Email

Please wait a few moments while the camera saves your settings and restarts.

Step 4: Setup Complete

You have completed your camera setup. Please click the Back button if you want to review or modify your settings or click on the Apply button to save and apply your settings.

Changes saved.IP Camera's network is restarting, please wait for 3 seconds ...

Network Setup

Use this section to configure the network connections for your camera. All relevant information must be entered accurately.

LAN Settings: Settings for your local area network.

DHCP: Select this connection if you have a DHCP server running on your network and would like your camera to obtain an IP address automatically.

Static IP Address: You may obtain a static or fixed IP address and other network information from your network administrator for your camera. A static IP address may simplify access to your camera in the future.

IP Address: Enter the fixed IP address in this field.

Subnet Mask: This number is used to determine if the destination is in the same subnet. The default value is 255.255.255.0.

Default Gateway: The gateway used to forward frames to destinations in a different subnet. Invalid gateway settings may cause the failure of transmissions to a different subnet.

Primary DNS: The primary domain name server translates names to IP addresses.

Secondary DNS: The secondary DNS acts as a backup to the primary DNS.

Enable UPnP: Enabling this setting allows your camera to be configured as a UPnP device on your network.

Enable UPnP Port Forwarding: Enabling this setting allows the camera to add port forwarding entries into the router automatically on a UPnP capable network.

D-Link

DCS-6616 // LIVE VIDEO SETUP ADVANCED MAINTENANCE STATUS HELP

NETWORK SETUP
You can configure your LAN and Internet settings here.
Save Settings Don't Save Settings

LAN SETTINGS

DHCP
 Static IP Client

IP address: 172.17.5.84
Subnet mask: 255.255.255.0
Default router: 172.17.5.254
Primary DNS: 192.168.168.250
Secondary DNS: 192.168.168.201

Enable UPnP presentation
 Enable UPnP port forwarding
Forwarding Port: 1024 test
Forwarding Status: UPnP forwarding is inactive

PPPoE SETTINGS

Enable Disable

User Name:
Password:
Confirm password:
PPPoE Status:

HTTP

HTTP port: 80
Access name for stream1: video1.mjpg
Access name for stream2: video2.mjpg
Access name for stream3: video3.mjpg

HTTPS

HTTPS port: 443

RTSP

RTSP port: 554
Access name for stream1: live1.sdp
Access name for stream2: live2.sdp
Access name for stream3: live3.sdp

TRAFFIC

Maximum Upload Bandwidth: 0 Kilo Bytes Per Second
Maximum Download Bandwidth: 0 Kilo Bytes Per Second

Save Settings Don't Save Settings

Helpful Hints...

Select DHCP Connection if you are running a DHCP server on your network and would like an IP address assigned to your IP camera automatically.

Enabling UPnP settings will allow you to configure your IP camera as an UPnP device in the network.

PPPoE Setting - If you use the IP camera to connect directly to the Internet, you will need to enter the username and password, which were given to you when you set up your account with your Internet Service Provider. If the camera is behind a router or a gateway, you do not need to configure this setting.

HTTP Port is the port you allocate in order to connect to the IP camera via a standard web browser.

HTTPS Port is a IP camera connects it with a PC via a secure web browser.

RTSP Port is the port you allocate in order to connect to a IP camera by using streaming mobile device(s), such as a mobile phone or PDA.

Traffic - Specifying the maximum download/upload bandwidth for each socket is useful when connecting your device to a busy or heavily loaded network.

**The value '0' means it will not monitor any traffic.

SECURITY

Enable PPPoE: Enable this setting if your network uses PPPoE.

User Name: The unique name of your account. You may obtain this information from your ISP.

Password: The password to your account. You may obtain this information from your ISP.

HTTP Port: The default port number is 80.

Access Name for Stream 1~3: The default name is video#.mjpg, where # is the number of the stream.

HTTPS Port: You may use a PC with a secure browser to connect to the HTTPS port of the camera. The default port number is 443.

RTSP Port: The port number that you use for RTSP streaming to mobile devices, such as mobile phones or PDAs. The default port number is 554. You may specify the address of a particular stream. For instance, live1.sdp can be accessed at rtsp://x.x.x.x/video1.sdp where the x.x.x.x represents the ip address of your camera.

Maximum Upload/Download Bandwidth: Specifying the maximum download/upload bandwidth for each socket can be useful when connecting your device to a busy or heavily loaded network. Entering a value of '0' indicates that the camera should not monitor bandwidth. Specifying other values will limit the camera's transfer speed to the specified number of Kilobytes per second.

D-Link

DCS-6616 // LIVE VIDEO SETUP ADVANCED MAINTENANCE STATUS HELP

NETWORK SETUP
You can configure your LAN and Internet settings here.
Save Settings Don't Save Settings

LAN SETTINGS

DHCP
 Static IP Client

IP address: 172.17.5.84
Subnet mask: 255.255.255.0
Default router: 172.17.5.254
Primary DNS: 192.168.168.250
Secondary DNS: 192.168.168.201

Enable UPnP presentation
 Enable UPnP port forwarding
Forwarding Port: 1024 test
Forwarding Status: UPnP forwarding is inactive

PPPOE SETTINGS

Enable Disable

User Name:
Password:
Confirm password:
PPPoE Status:

HTTP

HTTP port: 80
Access name for stream1: video1.mjpg
Access name for stream2: video2.mjpg
Access name for stream3: video3.mjpg

HTTPS

HTTPS port: 443

RTSP

RTSP port: 554
Access name for stream1: live1.sdp
Access name for stream2: live2.sdp
Access name for stream3: live3.sdp

TRAFFIC

Maximum Upload Bandwidth: 0 Kilo Bytes Per Second
Maximum Download Bandwidth: 0 Kilo Bytes Per Second

Save Settings Don't Save Settings

Helpful Hints...

Select DHCP Connection If you are running a DHCP server on your network and would like an IP address assigned to your IP camera automatically.

Enabling UPnP settings will allow you to configure your IP camera as an UPnP device in the network.

PPPoE Setting - If you use the IP camera to connect directly to the Internet, you will need to enter the username and password, which were given to you when you set up your account with your Internet Service Provider. If the camera is behind a router or a gateway, you do not need to configure this setting.

HTTP Port is the port you allocate in order to connect to a IP camera via a standard web browser.

HTTPS Port in a IP camera connects it with a PC via a secure web browser.

RTSP Port is the port you allocate in order to connect to a IP camera by using streaming mobile device(s), such as a mobile phone or PDA.

Traffic - Specifying the maximum download/upload bandwidth for each socket is useful when connecting your device to a busy or heavily loaded network.

*The value '0' means it will not monitor any traffic.

SECURITY

Dynamic DNS

DDNS (Dynamic Domain Name Server) will hold a DNS host name and synchronize the camera's public IP address when it has been modified. A user name and password are required when using the DDNS service.

Enable DDNS: Select this checkbox to enable the DDNS function.

Server Address: Select your Dynamic DNS provider from the drop-down menu or enter the server address manually.

Host Name: Enter the host name of the DDNS server.

User Name: Enter your user name or e-mail used to connect to the DDNS.

Password: Enter your password used to connect to the DDNS server.

Timeout: Enter DNS Timeout values.

Status: Indicates the connection status, which is automatically determined by the system.

Product: DCS-6616 Firmware Version : 0.04

D-Link

DCS-6616 // LIVE VIDEO SETUP ADVANCED MAINTENANCE STATUS HELP

Setup Wizard
Network Setup
Dynamic DNS
Image Setup
Audio and Video
PTZ Setup
Preset
Motion Detection
Time and Date
Event Setup
SD Card
Logout

DYNAMIC DNS

The Dynamic DNS feature allows you to use a domain name that you have purchased (www.yourdomain.com) to access your IP camera with a dynamically assigned IP address. Most broadband Internet service providers assign dynamic (changing) IP addresses. By using a DDNS service, you can enter your domain name to connect to your IP camera no matter what your IP address is.

[Sign up for D-Link's Free DDNS service at www.DLinkDDNS.com.](http://www.dlinkddns.com)

Save Settings Don't Save Settings

DYNAMIC DNS SETTING

Enable DDNS

Server Address <<

Host Name

User Name

Password

Verify Password

Timeout (hours)

Status Inactive

Save Settings Don't Save Settings

Helpful Hints...

Dynamic DNS is useful if you have a DSL or Cable service provider that changes your modem IP address periodically. This will allow you to assign a website domain name to your IP camera instead of connecting through an IP address.

Image Setup

Adjustments to these settings will affect the amount of network resources that the camera will use.

Enable Privacy Mask

Mask: Select this checkbox to enable the privacy mask.

Transparency: Turning transparency on allows you to see through the privacy mask area.

Color: This is the color that will be displayed over the masked area.

Number: Select which mask area you would like to set. You may set up to 16 different masked areas.

H Size: Specifies the horizontal length of the masked area in pixels.

V Size: Specifies the vertical length of the masked area in pixels.

The screenshot displays the D-Link DCS-6616 web interface. The top navigation bar includes 'LIVE VIDEO', 'SETUP', 'ADVANCED', 'MAINTENANCE', 'STATUS', and 'HELP'. The left sidebar lists various setup options, with 'Image Setup' selected. The main content area is titled 'IMAGE SETUP' and contains a 'LIVE VIDEO' section showing a camera feed with a privacy mask. The 'IMAGE SETUP' section includes settings for BLC, WDR, White Balance, Flip, Inverse, AE Mode, Brightness, Contrast, Saturation, Sharpness, and Expcomp. The 'LIVE VIDEO' section includes settings for Enable Privacy Mask, Transparency, Color, Number, H Size, and V Size. The 'Helpful Hints' sidebar on the right provides explanations for various features like Privacy Mask, BLC, WDR, White Balance, ATW, Inverse, AE Mode, Shutter, and Gain.

BLC: This function will enable backlight compensation, if the object is in front of strong backlight.

WDR: Wide Dynamic Range - This function allows the camera to be installed in high contrast and backlit environments.

White Balance: It is the process of removing unrealistic color casts, so that an object appears white in person that is correctly rendered as white on the screen.

Flip: You may choose Mechanical (M.E.) Flip or Image (digital) Flip. Mechanical Flip uses the PTZ mechanism, while Image Flip uses the digital system to flip the image.

Inverse: Turn this option on to invert the image.

AE Mode: This feature automatically sets the aperture and shutter speed, if Auto is selected. If Manual is selected, you may specify the shutter speed and gain. You may also select Shutter Priority and specify the shutter speed.

Brightness: Adjust this control to compensate for brightly backlit camera images.

Contrast: Adjust this control to increase or decrease the contrast of the camera image.

Saturation: Adjust this control to increase/decrease the color saturation of the picture.

Sharpness: This function controls the amount of sharpening applied to the image.

Excomp: Exposure compensation can be used to adjust exposure.

Reset to Defaults: Click this button to reset these settings to their defaults.

The screenshot displays the D-Link web interface for the DCS-6616 camera. The top navigation bar includes 'LIVE VIDEO', 'SETUP', 'ADVANCED', 'MAINTENANCE', 'STATUS', and 'HELP'. The left sidebar lists various setup options like 'Setup Wizard', 'Network Setup', 'Dynamic DNS', 'Image Setup', 'Audio and Video', 'PTZ Setup', 'Preset', 'Motion Detection', 'Time and Date', 'Event Setup', 'SD Card', and 'Logout'. The main content area is titled 'IMAGE SETUP' and contains a 'LIVE VIDEO' section with a camera feed and a 'IMAGE SETTINGS' section with various controls. The 'LIVE VIDEO' section includes a 'Privacy Mask' option with a transparency slider and color selection. The 'IMAGE SETTINGS' section includes checkboxes for BLC, WDR, and Inverse, and dropdown menus for White Balance, Flip, AE Mode, Shutter, Gain, Brightness, Contrast, Saturation, Sharpness, and Expcomp. A 'Reset Default' button is located at the bottom of the settings section. On the right side, there is a 'Helpful Hints...' section with text explaining the functions of Privacy Mask, BLC, WDR, White Balance, ATW, Inverse, AE Mode, Shutter, and Gain.

Audio and Video

You may configure 3 video profiles with different settings for your camera. Hence, you may set up different profiles for your computer and mobile display. In addition, you may also configure the two-way audio settings for your camera.

Mode: You may select H.264, MPEG4 or MJPEG encoding.

Frame Size: This option allows the user to choose the video resolution of the camera. The options include NTSC: D1 (720x480), CIF (352x240), QCIF (176x120) and PAL: D1 (720x576), CIF (352x288), QCIF (176x144).

Maximum Frame Rate: A higher frame rate provides smoother motion for video. Lower frame rates will result in stuttering.

Video Quality: Select the number of frames to be captured per second. 30fps is the highest video quality for this device.

Constant Bit Rate: This limits the maximal refresh frame rate, which can be combined with the “Fixed quality” to optimize the bandwidth utilization and video quality. To set the bandwidth utilization regardless of the video quality, choose “Constant bit rate” and select the desired bandwidth.

Fixed Quality: Select the image quality level of the video. You may choose **Standard**, **Good**, or **Excellent**.

Audio In Off: Select this option to disable Audio In.

Audio In Gain Level: Select 20 or 26 dB to make the audio louder.

Audio Out Off: Select this option to disable Audio Out.

Audio Out Volume Level: Choose a level between 1 and 10.

D-Link

DCS-6616 // LIVE VIDEO SETUP ADVANCED MAINTENANCE STATUS HELP

Setup Wizard
 Network Setup
 Dynamic DNS
 Image Setup
Audio and Video
 PTZ Setup
 Preset
 Motion Detection
 Time and Date
 Event Setup
 SD Card
 Logout

AUDIO AND VIDEO

This section allows you to configure the sound and video of your camera. You can configure different settings depending on whether you are viewing content from a PC or a Mobile Phone / PDA.

Save Settings Don't Save Settings

VIDEO PROFILE 1

Mode: H.264
 Frame size: 720x480
 Maximum frame rate: 30
 Video quality: Constant bit rate (2M), Fixed quality (Excellent)

VIDEO PROFILE 2

Mode: JPEG
 Frame size: 720x480
 Maximum frame rate: 30
 Video quality: Excellent

VIDEO PROFILE 3

Mode: MPEG4
 Frame size: 352x240
 Maximum frame rate: 30
 Video quality: Constant bit rate (2M), Fixed quality (Excellent)

AUDIO SETTINGS

Audio in off
 Audio in gain level: 20dB
 Audio out off
 Audio out volume level: 10

Save Settings Don't Save Settings

Helpful Hints...

Higher frame size, frame rate and bitrate rate gives better video quality. At the same time, it requires more network bandwidth.

For best viewing results on a mobile phone, we suggest setting the Frame Rate to 15fps and the Bit Rate to 64Kbps.

Mode: It can be either JPEG or MPEG4. In JPEG mode, the video frames are independent. However, MPEG4 consumes much less network bandwidth than JPEG.

Frame Size: 3 options exist for the sizes of the video display. It is recommended using 160x120 for mobile viewing and 720x480 for computer viewing.

Max frame rate: The maximum number of frames that is displayed in 1 second. 30fps is the highest video quality for this camera. In general, any frame rate above 15 fps is imperceptible to the human eye.

Video Quality: This limits the maximal refresh frame rate, which can be combined with the "Fixed quality" to optimize the bandwidth utilization and video quality. If the User wants to fix the bandwidth utilization regardless of the video quality, choose "Constant bit rate" and select the desired bandwidth.

Audio Settings: You can use the option to switch the external microphone on/off or adjust the volume.

SECURITY

PTZ Setup

This page allows you to configure the pan/tilt/zoom settings for the camera. Changes to settings on this page take place immediately.

Auto Pan: Auto Pan scans an area horizontally from left to right or right to left. Up to 4 Auto Pan paths may be defined. Select the button next to the path that you would like to set. Use the navigation pad to move the camera view to the desired start point and click **Set Start Point**. Move the camera view to the desired end point and click **Set End Point**. You may also specify the pan direction and speed. Click the **Test** button to view the path that you have just defined. Click **Stop** to end the test.

Cruise: A Cruise path is a stored route defined through manual adjustment of pan, tilt, and zoom. Up to 4 Cruise paths may be defined. Select the button next to the path that you would like to set. Click **Record Start** to begin recording a path. Use the navigation pad or mouse to define a path within the live video window. Click **Record End** when you are done defining the path. Click the **Test** button to view the path that you have just defined. Click **Stop** to end the test.

Home: You may turn on the home function and specify the PTZ behavior.

Digital Zoom: You may turn digital zoom on or off.

Freeze: If this option is turned on, the image will freeze at the end of the predefined path and return to the starting point.

The screenshot displays the D-Link DCS-6616 PTZ Setup web interface. The top navigation bar includes tabs for LIVE VIDEO, SETUP, ADVANCED, MAINTENANCE, STATUS, and HELP. The left sidebar lists various setup options, with PTZ Setup selected. The main content area is titled 'PTZ SETUP' and contains the following sections:

- LIVE VIDEO:** Shows a live video feed of a building entrance. To the right is a navigation pad with arrows and a center button. Below the pad are dropdown menus for Pan Speed (16) and Tilt Speed (16).
- AUTO PAN:** Includes a dropdown for Path (1), a dropdown for Direction (Right), and a dropdown for Speed (1). Buttons for Set Start Point, Set End Point, Test, and Stop are present.
- CRUISE:** Includes a dropdown for Path (1) and buttons for Record Start, Record End, Test, and Stop.
- MISCELLANEOUS:** Contains several settings:
 - Home: Radio buttons for ON and OFF.
 - Mode: A dropdown menu set to Preset.
 - Path: A dropdown menu set to 1.
 - Delay: A dropdown menu set to 1.
 - Modify: A button.
 - Digital Zoom: Radio buttons for ON and OFF.
 - Freeze: Radio buttons for ON and OFF.
 - Auto Calibration: Radio buttons for ON and OFF.
 - 2DNR: Radio buttons for ON and OFF.
 - 3DNR: Radio buttons for ON and OFF.
 - Tilt Angle: Min (10) and Max (80) dropdown menus.

On the right side of the interface, there is a 'Helpful Hints...' section with the following text:

- Auto Pan** - This function is to set camera's axis in horizontal view.
- Cruise** - This is a route formed with manual operation, through adjusting pan, tilt position and zoom parameters, which can be stored and recalled to execute repeatedly.
- Home Function** - The item is used to enable or disable the HOME function.

The bottom of the interface features a 'SECURITY' banner.

Auto Calibration: Turning this option on will automatically calibrate the camera when needed to ensure that the

2DNR: This option turns on 2D noise reduction which may improve picture quality.

3DNR: This option turns on 3D noise reduction which may further improve image quality.

Tilt Angle: The option allows you to adjust the minimum and maximum tilt angle of the camera.

The screenshot displays the D-Link web interface for the DCS-6616 camera. The interface is organized into several sections:

- PTZ SETUP:** A notification states, "Changes to your IP camera settings are made immediately." Below this is a "LIVE VIDEO" section showing a camera feed of a building entrance and a directional control pad. The "Pan Speed" and "Tilt Speed" are both set to 16.
- AUTO PAN:** The "Path" is set to 1, "Direction" is "Right", and "Speed" is 1. There are buttons for "Set Start Point", "Set End Point", "Test", and "Stop".
- CRUISE:** The "Path" is set to 1, with buttons for "Record Start", "Record End", "Test", and "Stop".
- MISCELLANEOUS:** This section contains various settings:
 - Home: ON OFF
 - Mode: Preset (dropdown), Path: 1, Delay: 1, and a "Modify" button.
 - Digital Zoom: ON OFF
 - Freeze: ON OFF
 - Auto Calibration: ON OFF
 - 2DNR: ON OFF
 - 3DNR: ON OFF
 - Tilt Angle: Mn: 10, Max: 80 (both dropdowns)

On the right side, there is a "Helpful Hints..." section with the following text:

- Auto Pan** - This function is to set camera's axis in horizontal view.
- Cruise** - This is a route formed with manual operation, through adjusting pan, tilt position and zoom parameters, which can be stored and recalled to execute repeatedly.
- Home Function** - The item is used to enable or disable the HOME function.

The bottom of the interface features a "SECURITY" banner.

Preset

This page allows you to define presets and a preset sequence for the camera image.

Preset: Use the navigation pad or mouse to target a specific view in the live video window. You may adjust the pan and tilt speed if needed.

Create a New Preset

1. Select the page number, between 1 and 26.
2. Select an unused preset number from the preset list.
3. Choose a name for the preset.
4. Click **Add**.

Remove a Preset

1. Select the page number.
2. Select the preset from the preset list.
3. Click **Remove**.

Rename a Preset

1. Select the page number.
2. Select the preset from the preset list.
3. Enter a new name for the preset, overwriting the old name.
4. Click **Rename**.

Set a Preset as the Home Position

1. Select the page number.
2. Select the preset from the preset list.
3. Click **Set**.

Reset the Home Position to Default

1. Click **Default**.

The screenshot shows the D-Link web interface for the DCS-6616 camera. The top navigation bar includes tabs for LIVE VIDEO, SETUP, ADVANCED, MAINTENANCE, STATUS, and HELP. The left sidebar contains a menu with options like Setup Wizard, Network Setup, Dynamic DNS, Image Setup, Audio and Video, PTZ Setup, Preset, Motion Detection, Time and Date, Event Setup, SD Card, and Logout. The main content area is titled 'PTZ PRESET' and contains the following sections:

- LIVE VIDEO:** A video window showing a camera view of a building entrance. To the right is a PTZ control pad with a central '+' button and four directional arrows. Below the pad are 'Pan Speed' and 'Tilt Speed' dropdown menus, both set to '16'.
- PRESET:** A section for creating and managing presets. It includes a 'Page No' dropdown (set to '1'), a 'Preset No' dropdown (set to '--Preset No--'), a 'Name' input field, and buttons for 'Add', 'Rename', 'Goto', and 'Remove'. Below this is a 'Choose' dropdown (set to '1-5555(H)') with the text 'as Home position.' and 'Set' and 'Default' buttons.
- PRESET SEQUENCE:** A table for defining a sequence of presets. It has columns for 'No.', 'Preset', 'Dwell time', and 'Speed'. The table contains three rows:

No.	Preset	Dwell time	Speed
1	1-5555(H)	5	5
2	2-7777	5	5
3	--Preset List--		

Helpful Hints on the right side of the page explain that PTZ controls move the camera view to the required position and that a preset sequence is an automated series of camera movements from one preset position to another, which can be set up to display video streams from different preset positions in a pre-determined order and for configurable time periods.

Preset Sequence: Sequence is an automated series of camera movements from one preset position to another. A sequence can be set up to display the video streams from different preset positions in a pre-determined order, and for configurable time periods.

Before creating a sequence, you must first define some presets. (Please see the previous page.)

Define a Preset Sequence

1. Specify a path number to use.
2. Specify up to 64 point numbers using the **Prev Page** and **Next Page** buttons to navigate between the sequence preset numbers:
 - a. Select a preset point from the Preset List.
 - b. Specify the Dwell Time.
 - c. Specify the Camera Speed.
3. Repeat steps a,b, and c, for up to 64 points.
4. Click **Save** to save your preset sequence.

D-Link

DCS-6616 // LIVE VIDEO SETUP ADVANCED MAINTENANCE STATUS HELP

Setup Wizard
Network Setup
Dynamic DNS
Image Setup
Audio and Video
PTZ Setup
Preset
Motion Detection
Time and Date
Event Setup
SD Card
Logout

PTZ PRESET
This section allows you to customize PTZ monitoring tracks.

LIVE VIDEO

192.168.1.100:8080
DCS-6616
TX

Pan Speed
Tilt Speed

PRESET

Page No
Preset Name
Preset List
Choose as Home position.

Add Rename
Goto Remove
Set Default

PRESET SEQUENCE

Path Goto Stop Prev Page Next Page

No.	Preset	Dwell time [1=127sec]	Speed [1=15]
1	<input type="text" value="1-5555(H)"/>	<input type="text" value="5"/>	<input type="text" value="5"/>
2	<input type="text" value="2-7777"/>	<input type="text" value="5"/>	<input type="text" value="5"/>
3	<input type="text" value="--Preset List--"/>	<input type="text"/>	<input type="text"/>

Helpful Hints...
Preset - Using the Pan, Tilt and Zoom (PTZ) controls, move the camera view to the required position.
Preset sequence - Sequence is an automated series of camera movements from one preset position to another. A guard tour can be set up to display the video streams from different preset positions in a pre-determined order, and for configurable time periods.

Motion Detection

This section allows you to enable and configure motion detection areas.

Enable Video Motion: Select this box to enable the motion detection feature of your camera.

Sensitivity: Specifies the measurable difference between two sequential images that would indicate motion. Please enter a value between 0 and 100.

Percentage: Specifies the amount of motion in the window being monitored that is required to initiate an alert. If this is set to 100%, motion is detected within the whole window will trigger a snapshot.

Draw Motion Area: Draw the motion detection area by dragging your mouse in the window (indicated by the red square).

Erase Motion Area: To erase a motion detection area, simply click on the red square that you wish to remove.

Right clicking on the camera image brings up the following menu options:

Select All: Draws a motion detection area over the entire screen.

Clear All: Clears any motion detection areas that have been drawn.

Restore: Restores the previously specified motion detection areas.

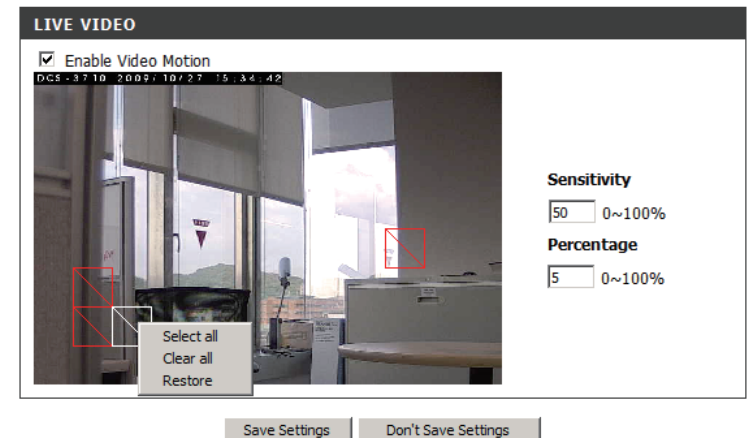
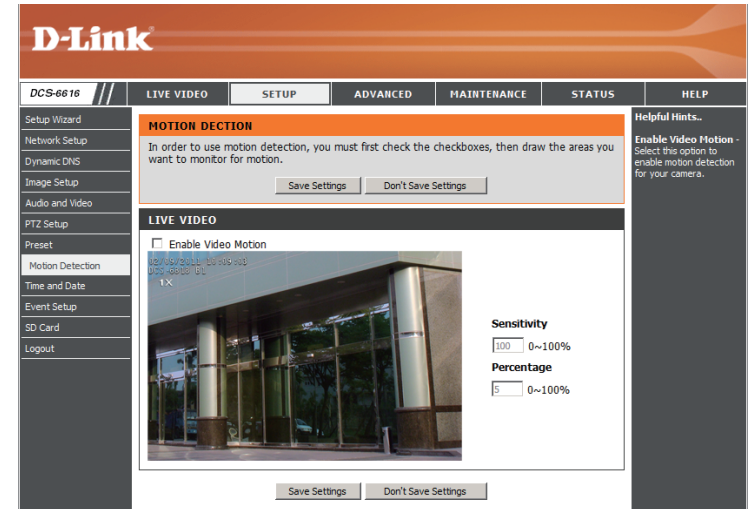

Time and Date

This section allows you to automatically or manually configure, update, and maintain the internal system clock for your camera.

Time Zone: Select your time zone from the drop-down menu.

Enable Daylight

Saving: Select this to enable Daylight Saving Time.

Auto Daylight Saving: Select this option to allow your camera to configure the Daylight Saving settings automatically.

Set Date and Time Manually: Selecting this option allows you to configure the Daylight Saving date and time manually.

Offset: Sets the amount of time to be added or removed when Daylight Saving is enabled.

Synchronize with NTP Server: Enable this feature to obtain time automatically from an NTP server.

NTP Server: Network Time Protocol (NTP) synchronizes the DCS-6616 with an Internet time server. Choose the one that is closest to your location.

Set the Date and

Time Manually: This option allows you to set the time and date manually.

Copy Your Computer's Time

Settings: This will synchronize the time information from your PC.

D-Link

DCS-6616 // LIVE VIDEO SETUP ADVANCED MAINTENANCE STATUS HELP

TIME AND DATE

You can set the current time for the IP camera.

Save Settings Don't Save Settings

TIME CONFIGURATION

Time Zone (GMT+08:00) Taipei

Enable Daylight Saving

Auto Daylight Saving

Set date and time manually

Offset +2:00

Month Week Day of week Hour Minutes

Start time 5 1 Sunday 0 00

End time 10 1 Sunday 0 00

AUTOMATIC TIME CONFIGURATION

Synchronize with NTP Server

NTP Server ntp.dlink.com.tw << Select NTP Server

SET DATE AND TIME MANUALLY

Set date and time manually

Year 2011 Month 2 Day 9

Hour 10 Minute 10 Second 20

Copy Your Computer's Time Settings

Save Settings Don't Save Settings

Helpful Hints...

Good timekeeping is important for accurate logs and scheduled firewall rules.

Time Zone: Select your time zone from the drop-down menu.

Enable Daylight Saving: Select this to enable the daylight saving time.

Auto Daylight Saving: When you select to the clock is automatically adjusted according to the daylight saving time of the selected time zone.

Offset: Select the time offset, if your location observes daylight saving time.

Synchronize with NTP Server: With the option selected, the camera will synchronize the time settings with the NTP server over the Internet whenever the camera starts up. If the timeserver cannot be reached, no time settings will be applied.

NTP Server: Network Time Protocol (NTP) synchronizes the IP camera with an Internet time server. Choose the one that is closest to your location.

Copy Your

Event Setup

The Event Setup page includes four different sections.

- Event
- Server
- Media
- Recording

1. To add a new item - "event, server or media," click **Add**. A screen will appear and allow you to update the fields accordingly.
2. To delete the selected item from the drop-down menu of event, server or media, click **Delete**.
3. Click on the item name to pop up a window for modifying.

Note: You can add up to four events, five servers, and five media fields.

D-Link

DCS-6616 // LIVE VIDEO SETUP ADVANCED MAINTENANCE STATUS HELP

EVENT SETUP

There are four sections in Event Setup page. They are event, server, media and recording. Click Add to pop a window to add a new item of event, server, media or recording. Click Delete to delete the selected item from event, server, media or recording. Click on the item name to pop a window to edit it. There can be at most three events and two recording. There can be at most five server and five media configurations.

SERVER

Name	Type	Address/Location
d1	sd card	

Add | d1 | Delete

MEDIA

Media freespace: 6700KB

Name	Type
sd	snapshot

Add | sd | Delete

EVENT

Name	Status	Sun	Mon	Tue	Wed	Thu	Fri	Sat	Time	Trigger
d1	ON	V	V	V	V	V	V	V	00:00~23:59	digital
d2	ON	V	V	V	V	V	V	V	00:00~23:59	motion

Add | d1 | Delete

RECORDING

Name	Status	Sun	Mon	Tue	Wed	Thu	Fri	Sat	Time	Source	Destination
ro	ON	V	V	V	V	V	V	V	00:00~23:59	Profile 1	SD

Add | ro | Delete

Helpful Hints..

Suggest setting server and media first before setting event. The servers and media which selected in event list are not be able to modify or delete. Please remove them first from the event if you want to delete or modify them. Recommend using different media in different event to make use all media be produced and received correctly. If using the same media in different events and the events trigger almost simultaneously, the servers in the second triggered event will not receive any media; there would be only notifications.

Application

In a typical application, when motion is detected, the DCS-6616 Network Camera sends images to a FTP server or via e-mail as notifications. As shown in the illustration below, an event can be triggered by many sources, such as motion detection or external digital input devices. When an event is triggered, a specified action will be performed. You can configure the Network Camera to send snapshots or videos to your e-mail address or FTP site.

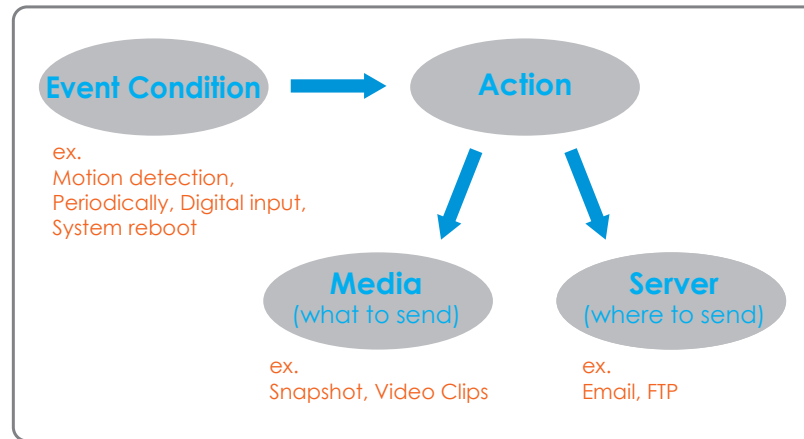

To start plotting an event, it is suggested to configure server and media columns first so that the Network Camera will know what action shall be performed when a trigger is activated.

Add Server

Configure up to 5 servers to store media.

Server Name: Enter the unique name of your server.

E-mail: Enter the configuration for the target e-mail server account.

FTP: Enter the configuration for the target FTP server account.

Network Storage: Specify a network storage device. Only one network storage device is supported.

D-Link

DCS-6616 // LIVE VIDEO SETUP ADVANCED MAINTENANCE STATUS HELP

Setup Wizard
Network Setup
Dynamic DNS
Image Setup
Audio and Video
Motion Detection
Time and Date
Event Setup
SD Card
Auto Focus
Logout

SERVER

You can set at most 5 different servers here for different event.

test Save Settings Don't Save Settings

SERVER TYPE

Server Name:

Email

Sender email address

Recipient email address

Server address

User name

Password

Port

This server requires a secure connection (StartTLS)

FTP

Server address

Port

User name

Password

Remote folder name

Passive mode

Network storage

Network storage location

(for example:\my_nas\disk\folder)

Workgroup

User name

Password

Primary WINS server

Helpful hints...

"Server name" The unique name for server. There are four kinds of servers supported. They are email server, FTP server, HTTP server and network storage.

Email server:
"Sender email address" The email address of the sender.
"Recipient email address" The email address of the recipient.

FTP server:
"Remote folder name" Granted folder on the external FTP server. The string must conform to that of the external FTP server. Some FTP servers cannot accept preceding slash symbol before the path without virtual path mapping. Refer to the instructions for the external FTP server for details. The folder privilege must be open for upload.
"Passive Mode" Check it to enable passive mode in transmission.

Network storage: Only one network storage is supported.
"Network storage location" The path to upload the media.
"Workgroup" The workgroup for network storage.

SD card:
Use the SD card for recording media.

Add Media

There are three types of media, **Snapshot**, **Video Clip** and **System Log**.

Media Name: Enter a unique name for media.

Snapshot: Select this option to enable snapshots.

Source: The stream source: **Profile 1**, **Profile 2** or **Profile 3**.

Send pre-event image(s) [0~4]: The number of pre-event images.

Send post-event image(s) [0~7]: The number of post-event images.

File name prefix: The prefix name will be added on the file name.

Add date and time suffix to file name: Check it to add timing information as file name suffix.

Video clip: Select this option to enable video clips.

Source: The source of the profile: **profile1**, **profile2**, or **profile3**.

Pre-event recording: The interval of pre-event recording in seconds.

Maximum duration: The maximal recording file duration in seconds.

Maximum file size: The maximal file size would be generated.

File name prefix: The prefix name will be added on the file name of the video clip.

System log: Select this option to save events to the camera system log.

D-Link

DCS-6616 // LIVE VIDEO SETUP ADVANCED MAINTENANCE STATUS HELP

MEDIA

You can set at most 5 different media here for different event.

Save Settings Don't Save Settings

MEDIA TYPE

Media name:

snapshot

Source:

Send pre-event image(s) [0~4]

Send post-event image(s) [0~7]

File Name Prefix:

Add date and time suffix to file name

Video Clip

Source:

Pre-event recording: Second(s) [0~4]

Maximum duration: Second(s) [1~100]

Maximum file size: Kbytes [100~3000]

File Name Prefix:

System log

Save Settings Don't Save Settings

Helpful Hints.

"Media name" The unique name for media. There are three kinds of media. They are snapshot, video clip and system log.

"Source" The source of profile, profile1 or profile2.

"Send Pre-event images" The number of pre-event images.

"Send Post-event images" The number of post-event images.

"File name prefix" The prefix name will be added on the file name of the snapshot images.

"Add date and time suffix to file name" Check it to add timing information as file name suffix.

"Video clip" The source of profile, profile1 or profile2.

"Pre-event recording" The interval of pre-event recording in seconds There are two limitations for video clip file.

"Maximum duration" The maximal recording file duration in seconds.

"Maximum file size" The maximal file size would be generated.

Send post-event image (s) [0~7]

Specify to capture the number of images after a trigger is activated. A maximum of seven images can be generated.

For example:

If both the Send pre-event images and Send post-event images are set to four, a total of 9 images are generated after a trigger is activated.

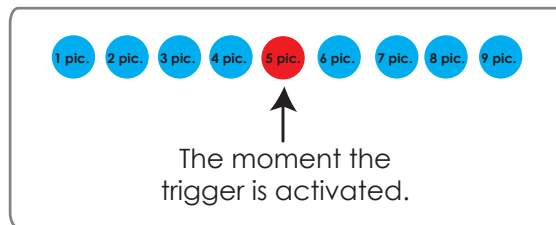

Add a date and time suffix to the file name

Select this option to add a date and time to the file name suffix.

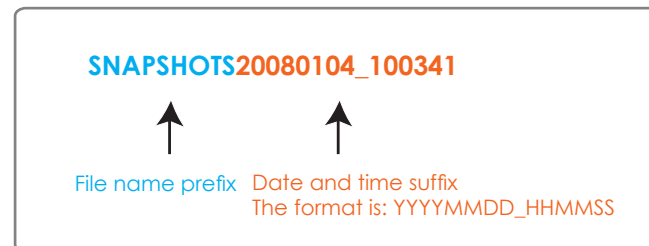

Maximum duration

Specify the maximal recording duration in seconds. You can set up to ten seconds.

For example:

If the Pre-event recording is set to five seconds and the Maximum duration is set to ten seconds, the Network Camera continues to record for another four seconds after a trigger is activated.

for another four seconds after a trigger is activated.

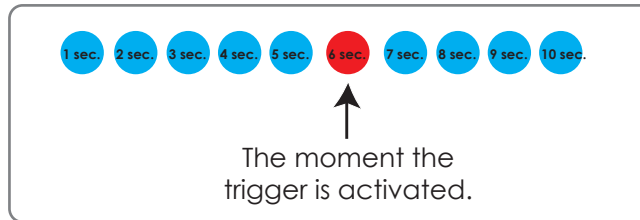

File name prefix

Enter the text that will be added at the beginning of the file name.

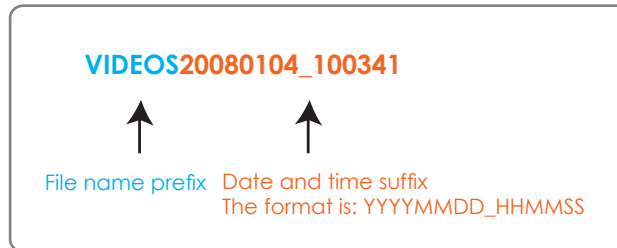

Add Event

Create and schedule up to three events with their own settings here.

Event name: Enter a name for the event.

Enable this event: Select this box to activate this event.

Priority: Set the priority for this event. The event with higher priority will be executed first.

Delay: Select the delay time before checking the next event. It is being used for both events of motion detection and digital input trigger.

Trigger: Specify the input type that triggers the event.

Video Motion Detection: Motion is detected during live video monitoring. Select the windows that need to be monitored.

Periodic: The event is triggered in specified intervals. The trigger interval unit is in minutes.

Digital Input: The external digital input trigger input to the camera.

System Boot: Triggers an event when the system boots up.

Network Lost: Triggers an event when the network is lost.

Time: Select **Always** or enter the time interval.

Trigger D/O: Select to trigger the digital output for a specific number of seconds when an event occurs.

Recording

Here you can configure and schedule the recording settings.

Recording entry

name: The unique name of the entry.

Enable this recording:

Select this to enable the recording function.

Priority: Set the priority for this entry. The entry with a higher priority value will be executed first.

Source: The source of the stream.

Recording schedule:

Scheduling the recording entry.

Recording settings: Configuring the setting for the recording.

Destination: Select the folder where the recording file will be stored.

Total cycling recording size: Please input a volume size between 1MB and 200GB for recording space. The recording data will replace the oldest record when the total recording size exceeds this value. For example, if each recording file is 6MB, and the total cyclic recording size is 600MB, then the camera will record 100 files in the specified location (folder) and then will delete the oldest file and create new file for cyclic recording.

Please note that if there is not enough free space, the recording will stop. Before you set up this option please make sure that sufficient free space is available. It is better to not save other files in the same folder as recordings.

Size of each file for recording:

File size for each recording file. You may input the value in the range of 200-5000.

File Name Prefix: The prefix name will be added on the file name of the recording file(s).

D-Link

DCS-6616 // LIVE VIDEO SETUP ADVANCED MAINTENANCE STATUS HELP

RECORDING

You can setup schedule recording to network storage with your specify week day and time period.

Save Settings Don't Save Settings

RECORDING

Recording entry name:

Enable this recording

Priority: [normal]

Source: [Profile 1]

RECORDING SCHEDULE

Sun Mon Tue Wed Thu Fri Sat

Time

Always

From [00] To [23] [59]

RECORDING SETTINGS

Destination [Server 1]

Total cycling recording size: [1000] Kbytes [1000~200000000]

Size of each file for recording: [200] Kbytes [200~5000]

File Name Prefix:

Save Settings Don't Save Settings

Helpful Hints..

Recording : Enable this option if you want to upload the recording to a shared folder on the network.

Recording schedule : Select the day(s) according to when you want the camera to make a video clip.

Always : This enables the camera to make video clips continuously.

From : The time range specified for the video clip.

Total cycling recording size : Please input the network path of your network storage, it will be like: \\DNS(IPCamRecord). If the network storage need authentication, please enter your user name and password here.

Note: Please Format CF card before use. The entire data in the CF card will be erased after formatting.

Note: Before you unplug the SD card from the slot, please select "Remove SD card" to ensure that your data is secure.

Advanced

DI and DO (Digital Input/Output)

The camera provides eight alarm inputs and one alarm output to connect alarm devices. With this function, the camera can cooperate with alarm system to catch event images.

No. # DI Type: Normal Open is for digital input that is activated when the circuit is closed.

Normal Close is for digital input that is activated when the circuit is opened.

For example: Connect the Alarm input terminal to ALM GND to activate [NC] or floating (unconnected) [NO] to deactivate

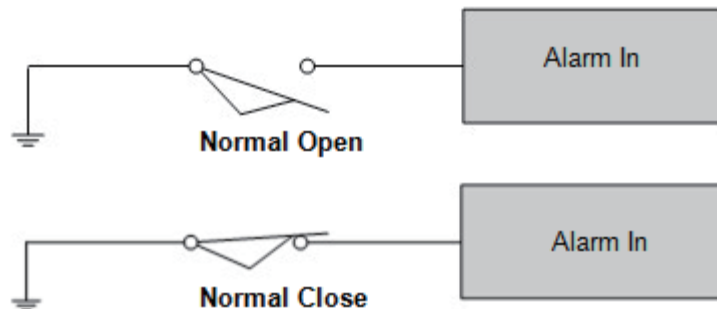

The screenshot shows the D-Link web interface for the DCS-6616 camera. The 'DI AND DO' section is active, showing the following settings:

- The I/O connector provides the physical interface for digital output (DO) and digital input (DI) that is used for connecting a diversity of external alarm devices such as IR-Sensors and alarm relays.
- The digital input is used for connecting external alarm devices and once triggered images will be taken and e-mailed.
- Buttons: Save Settings, Don't Save Settings
- DI AND DO settings:
 - Digital Input 1: The active state is ; the current state detected is **Normal Open**
 - Digital Input 2: The active state is ; the current state detected is **Normal Open**
 - Digital Input 3: The active state is ; the current state detected is **Normal Open**
 - Digital Input 4: The active state is ; the current state detected is **Normal Open**
 - Digital Input 5: The active state is ; the current state detected is **Normal Open**
 - Digital Input 6: The active state is ; the current state detected is **Normal Open**
 - Digital Input 7: The active state is ; the current state detected is **Normal Open**
 - Digital Input 8: The active state is ; the current state detected is **Normal Open**
 - Digital Output: The active state is

Helpful Hints... The network ipcam str provides a general I/O terminal block with one digital input and one relay switch for device control. Pin DI+ and pin DI- can be connected to an external sensor and the state of voltage will be monitored from the initial state 'LOW'. The relay switch of pin DO+ and pin DO- can be used to turn on or off the external device. Please refer to manual for detail connection diagram. LED in the rear panel of your camera, there is a LED beside the network adapter. ON: The LED will flash a light to indicate if the network is working or not. OFF: No light will show, forth option is turn off.

ICR

The Infrared Cut-Removable(ICR) filter can be disengaged for increased sensitivity in low light environments. The ICR filter will automatically engage depending on the ambient light, allowing the camera to be effective in day/night environments.

Automatic (Default): The day/Night mode is set automatically. It will typically use day mode, but will use night mode if installed in a dark area.

Day Mode: The Day mode disables the IR Cut Filter.

Night Mode: The Night mode enables the IR Cut Filter.

Schedule Mode: You can specify a time period for which Day mode will always be used.

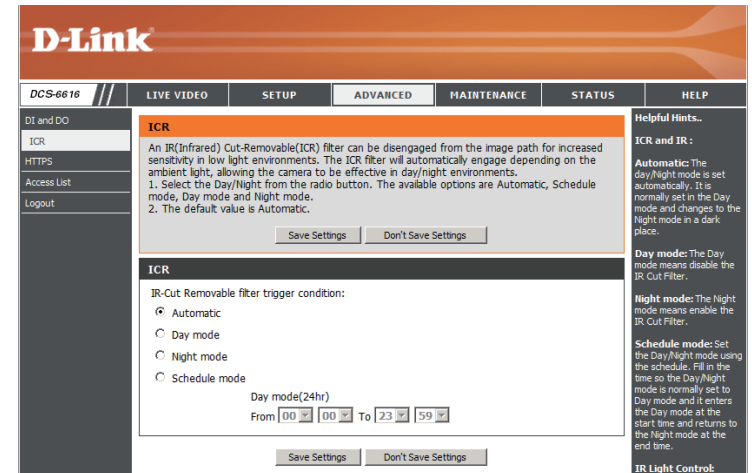

HTTPS

This page allows you to install and activate an HTTPS certificate for secure access to your camera.

Enable HTTPS

Secure Connection: Enable the HTTPS service.

Create Certificate Method: Choose the way the certificate should be created. Three options are available:

- Create a self-signed certificate automatically
- Create a self-signed certificate manually
- Create a certificate request and install

Status: Displays the status of the certificate.

Note: The certificate cannot be removed while the HTTPS is still enabled. To remove the certificate you must first uncheck **Enable HTTPS secure connection**.

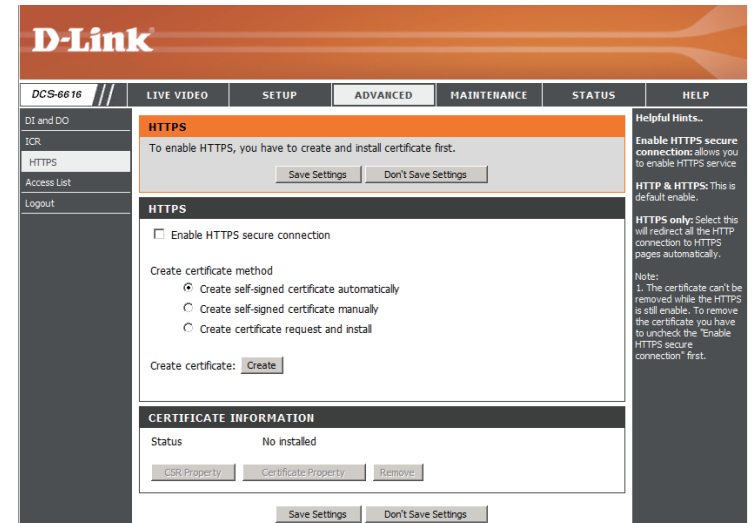

Access List

Here you can set access permissions for users to view your DCS-6616.

Allow list: The list of IP addresses that have the access right to the camera.

Start IP address: The starting IP Address of the devices (such as a computer) that have permission to access the video of the camera. Click **Add** to save the changes made.

Note: A total of seven lists can be configured for both columns.

End IP address: The ending IP Address of the devices (such as a computer) that have permission to access the video of the camera.

Delete allow list: Remove the customized setting from the Allow List.

Deny list: The list of IP addresses that have no access right to the camera.

Delete deny list: Remove the customized setting from the Delete List.

For example:

When the range of the Allowed List is set from 1.1.1.0 to 192.255.255.255 and the range of the Denied List is set from 1.1.1.0 to 170.255.255.255. Only users with IPs located between 171.0.0.0 and 192.255.255.255 can access the Network Camera.

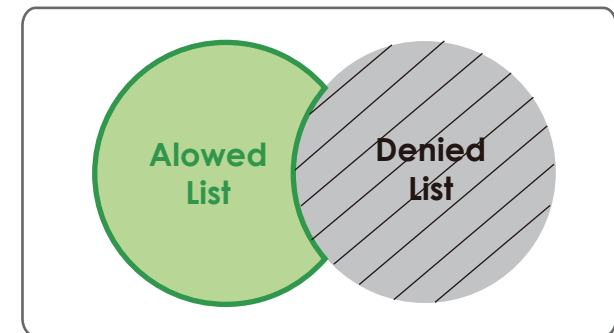
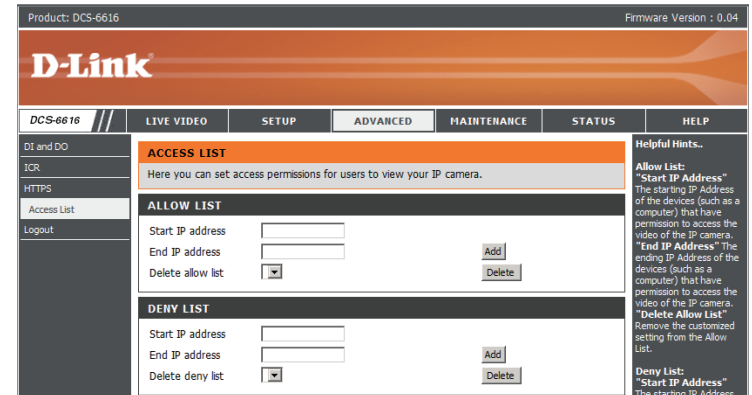

Maintenance Admin

You may modify the name and administrator's password of your camera, as well as add and manage the user accounts for accessing the camera. You may also use this section to create the unique name and configure the OSD setting for your camera.

Admin Password

Setting: Set a new password for the administrator's account.

Add User Account: Add new user account.

User Name: The user name for the new account.

Password: The password for the new account.

User List: All the existing user accounts will be displayed here. You may delete accounts included in the list, but please reserve at least one as guest.

Camera Name: Create a unique name for your camera that will be added to the file name prefix when creating a snapshot or a video clip.

Enable OSD: Select this option to enable the On-Screen Display feature for your camera.

Label: Enter a label for the camera.

Show Time: Select this option to enable the time-stamp display on the video screen.

The screenshot displays the 'Maintenance Admin' web interface for a DCS-6616 camera. The interface is organized into several sections:

- ADMIN:** A header section explaining that users can change the administrator's password, add/delete user accounts, and enable the OSD (On-Screen Display) feature.
- ADMIN PASSWORD SETTING:** Contains two input fields for 'New Password' and 'Retype Password', both with a maximum length of 8 characters. A 'Save' button is located below the fields.
- ADD USER ACCOUNT:** Contains three input fields for 'User Name' (20 users maximum), 'New Password' (8 characters maximum), and 'Retype Password'. An 'Add' button is positioned below the fields.
- USER LIST:** Features a dropdown menu labeled '-- User list --' and a 'Delete' button.
- DEVICE SETTING:** Includes fields for 'IP camera Name' and 'Label' (both 30 characters maximum), a checked 'Enable OSD' checkbox, and a 'Show time' checkbox. A 'Save' button is at the bottom.
- Helpful Hints...:** A sidebar on the right providing security advice, such as recommending password changes and ensuring at least one user account is reserved as a guest.

Backup and Restore

In this section, you may backup, restore and reset the camera configuration, or reboot the camera.

Save To Local Hard Drive: You may save and document your current settings into your computer.

Local From Local Hard Drive: Locate a pre-saved configuration by clicking **Browse** and then restore the pre-defined settings to your camera by clicking **Load Configuration**.

Restore to Factory Default: You may reset your camera and restore the factory settings by clicking **Restore Factory Defaults**.

Reboot Device: This will restart your camera.

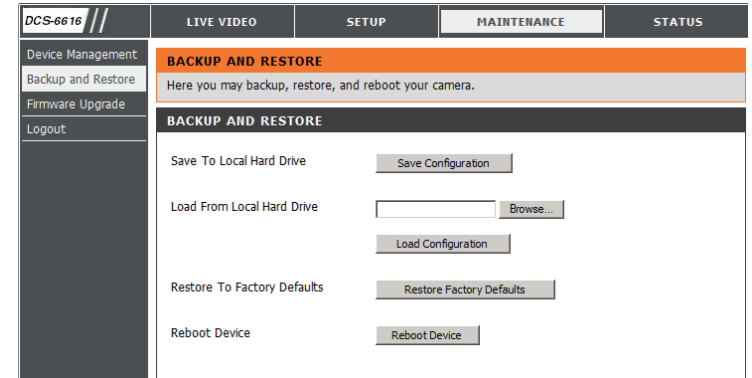

Firmware Upgrade

The camera's current firmware version will be displayed on this screen. You may visit the D-Link Support Website to check for the latest available firmware version.

To upgrade the firmware on your DCS-6616, please download and save the latest firmware version from the D-Link Support Page to your local hard drive. Locate the file on your local hard drive by clicking the **Browse** button. Select the file and click the **Upload** button to start upgrading the firmware.

Current Firmware

Version: Displays the detected firmware version.

Current Product Name: Displays the camera model name.

File Path: Locate the file (upgraded firmware) on your hard drive by clicking **Browse**.

Upload: Uploads the new firmware to your camera.

DCS-6616 //	LIVE VIDEO	SETUP	MAINTENANCE	STATUS
Device Management	FIRMWARE UPGRADE A new firmware upgrade may be available for your IP camera. It is recommended to keep your IP camera firmware up-to-date to maintain and improve the functionality and performance of your internet camera. Click here D-Link Support Page to check for the latest firmware version available. To upgrade the firmware on your IP camera, please download and save the latest firmware version from the D-Link Support Page to your local hard drive. Locate the file on your local hard drive by clicking the Browse button. Once you have found and opened the file using the browse button, click the "Upload" button to start the firmware upgrade.			
Backup and Restore				
Firmware Upgrade				
Logout				
FIRMWARE INFORMATION Current Firmware Version: DCS-6616 Current Product Name : 1.0.9				
FIRMWARE UPGRADE File Path: <input type="text"/> <input type="button" value="Browse..."/> <input type="button" value="Upload"/>				

Status

Device Info

This section displays detailed information about your device and network settings.

The screenshot shows the D-Link web interface for the DCS-6616 device. The top navigation bar includes links for LIVE VIDEO, SETUP, ADVANCED, MAINTENANCE, STATUS (selected), and HELP. The left sidebar contains links for Device Info (selected), Log, and Logout. The main content area is titled 'DEVICE INFO' and contains a descriptive paragraph and an 'INFORMATION' table.

INFORMATION	
IP camera Name	DCS-6616
Time & Date	Fri Feb 18 11:38:18 2011
Firmware Version	0.04.02
MAC Address	00:30:46:01:0C:7D
IP Address	172.17.5.57
IP Subnet Mask	255.255.255.0
Default Gateway	172.17.5.254
Primary DNS	192.168.168.250
Secondary DNS	192.168.168.201
PPPoE	Disable
DDNS	Disable
TV Output Mode	NTSC

Helpful Hints..
This page displays all the information about the IP camera and network settings.

Logs

This page displays the log information of your camera. You may download the information by clicking **Download**. You may also click **Clear** to delete the saved log information.

Product: DCS-6616		Firmware Version : 0.04	
D-Link			
DCS-6616 //	LIVE VIDEO	SETUP	ADVANCED
		MAINTENANCE	STATUS
			HELP
Device Info	SYSTEM LOG		Helpful Hints.. You can save the log to your local hard IP camera by clicking the Download button, and you can clear the log by clicking on the Clear button.
Log	The system log records IP camera events that have occurred.		
Logout	CURRENT LOG		
	<ol style="list-style-type: none"> 1. 2011-02-09 10:01:12 admin LOGIN OK FROM 172.17.5.95 2. 2011-02-09 09:49:46 IP CAMERA ACQUIRE DHCP IP 172.17.5.103 3. 2011-02-09 09:49:29 SYSTEM BOOTING 4. 2011-01-21 16:02:18 admin SET EVENT RECORD 1 5. 2011-01-21 16:01:02 admin LOGIN OK FROM 172.17.5.22 6. 2011-01-21 16:00:12 admin SET EVENT TYPE 2 7. 2011-01-21 15:59:51 admin SET EVENT TYPE 1 8. 2011-01-21 15:59:21 admin SET EVENT SERVER 1 9. 2011-01-21 15:56:19 admin SET EVENT RECORD 1 10. 2011-01-21 15:55:56 admin SET EVENT MEDIA 1 11. 2011-01-21 15:54:30 admin SET EVENT TYPE 1 12. 2011-01-21 15:53:22 admin LOGIN OK FROM 172.17.5.84 13. 2011-01-21 15:43:20 admin FROM 172.17.5.22 SET ALL IMAGE DATA DEFAULT 14. 2011-01-21 15:43:13 admin FROM 172.17.5.22 SET ALL IMAGE DATA DEFAULT 15. 2011-01-21 15:21:58 admin LOGIN OK FROM 172.17.5.22 16. 2011-01-21 15:19:43 IP CAMERA ACQUIRE DHCP IP 172.17.5.145 17. 2011-01-21 15:19:27 SYSTEM BOOTING 18. 2011-01-21 15:15:50 NETWORK LOST 19. 2011-01-20 00:46:16 admin LOGIN OK FROM 172.17.5.125 20. 2011-01-20 00:45:58 IP CAMERA ACQUIRE DHCP IP 172.17.5.145 		
	<input type="button" value="First Page"/> <input type="button" value="Previous 20"/> <input type="button" value="Next 20"/>		
	<input type="button" value="Clear"/> <input type="button" value="Download"/>		

Help

This page provides helpful information regarding camera operation.

The screenshot shows the web interface for the D-Link DCS-6616 camera. At the top, it displays 'Product: DCS-6616' and 'Firmware Version : 0.04'. Below this is the D-Link logo. A navigation bar contains tabs for 'DCS-6616', 'LIVE VIDEO', 'SETUP', 'ADVANCED', 'MAINTENANCE', 'STATUS', and 'HELP'. The 'HELP' tab is selected. On the left side, there is a sidebar with 'Help' and 'Logout' links. The main content area is titled 'HELP' and contains a list of links: LIVE VIDEO, SETUP, MAINTENANCE, ADVANCED, and STATUS. Each category is expanded to show its sub-items:

- HELP**
 - [LIVE VIDEO](#)
 - [SETUP](#)
 - [MAINTENANCE](#)
 - [ADVANCED](#)
 - [STATUS](#)
- LIVE VIDEO**
 - [Camera](#)
- SETUP**
 - [Setup Wizard](#)
 - [Network Setup](#)
 - [Dynamic DNS](#)
 - [Image Setup](#)
 - [Audio and Video](#)
 - [Motion Detection](#)
 - [Time and Date](#)
 - [Event Setup](#)
 - [Lens Control](#)
- ADVANCED**
 - [DI and DO](#)
 - [HTTPS](#)
 - [Access List](#)
- MAINTENANCE**
 - [Admin](#)
 - [System](#)
 - [Firmware Upgrade](#)

DI/DO Configuration

DI/DO Pin Block Specifications

The network Speed Dome Camera's 22-pin connector definition is listed as shown below.

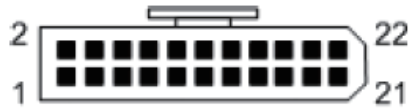

Pin	Definition	Cable	Pin	Definition	Cable
1	DC12V IN	RED (18AWG)	2	ALM NC	WHITE
3	GND	BLACK (18AWG)	4	ALM NO	BLACK/WHITE
5		YELLOW (18AWG)	6	ALM COM	GREEN/BLACK
7	Audio in	YELLOW	8	Audio out	ORANGE
9	Audio GND	GREEN	10	Audio GND	BROWN
11	ISOG	BLUE/WHITE	12	ALM-1	RED/WHITE
13	ALM-3	PURPLE	14	ALM-2	GREY
15	ALM-4	BLUE	16	ALM-5	WHITE/BLACK
17	ALM-6	ORANGE/BLACK	18	ALM-7	PURPLE/WHITE
19	ALM-8	GREY/BLACK	20	ALM GND	BROWN/WHITE
21	VGND	BLACK	22	Video	RED

Digital Input Diagram

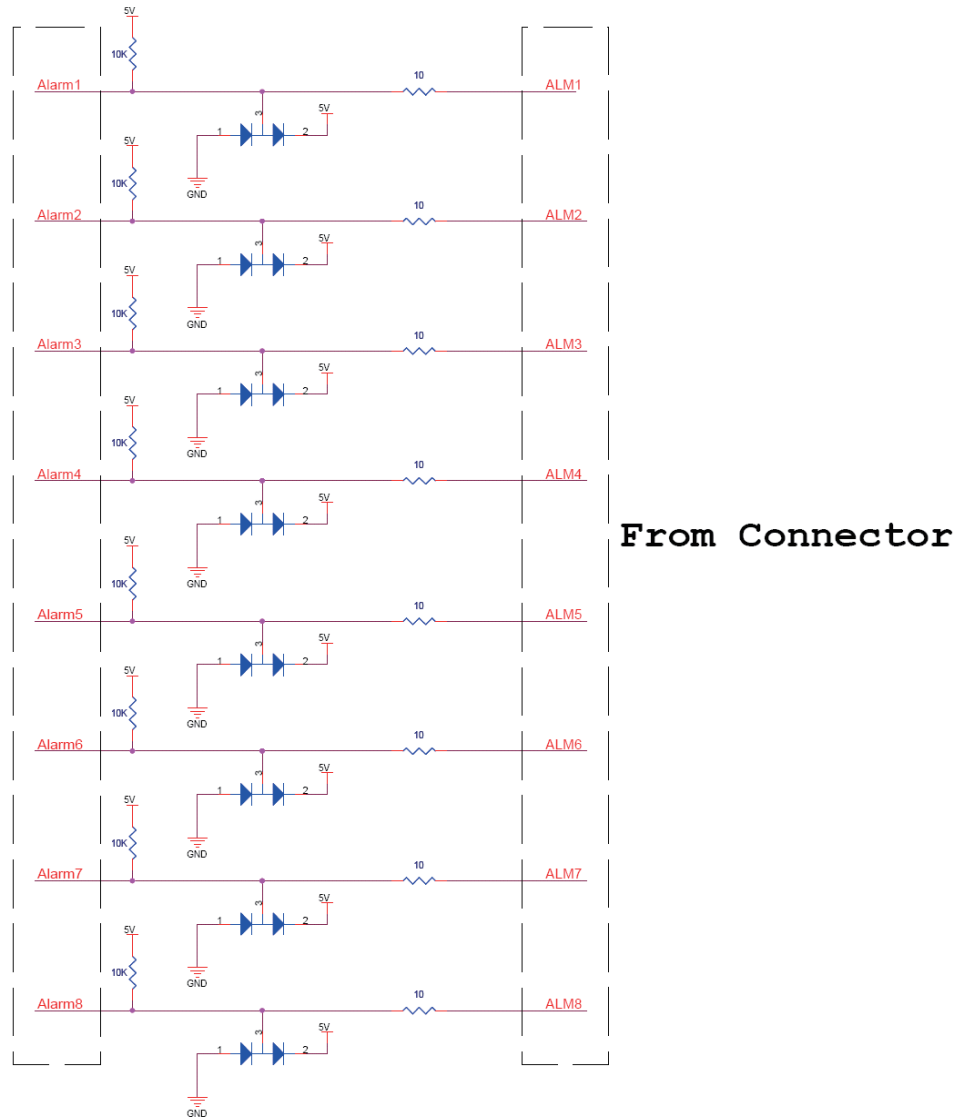

Alarm Input: ALM-1 ~ 8 - ALM GND

Digital Output Diagram

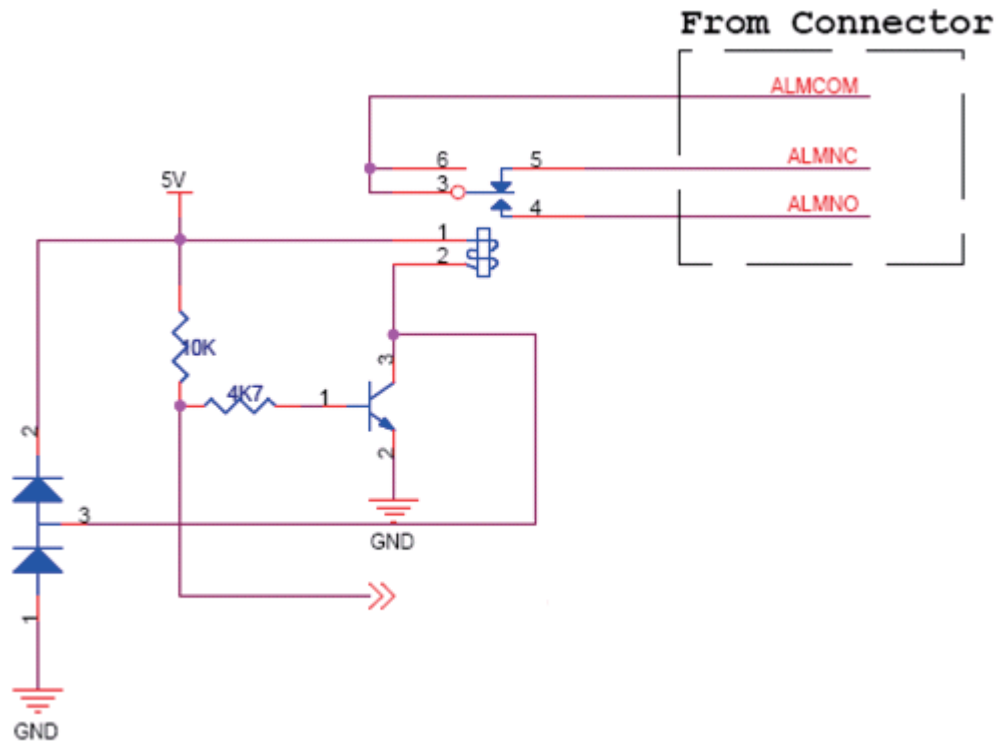

Alarm Output: ALM NC / ALM NO – ALM COM (NC: normal close, NO: normal open)
 Max. load 3A, max. voltage 120V AC relay output.

Technical Specifications

Camera	Camera Hardware Profile	<ul style="list-style-type: none"> ▪ Sony Super HAD-II 1/4" CCD sensor ▪ 650 TVL resolution ▪ Minimum illumination: 0.1 lux (Color), 0.01 lux (B/W) ▪ Built-in Infrared-Cut Removable (ICR) ▪ Iiter module ▪ Electronic shutter: 1 to 1/10000 second ▪ S/N ratio > 50 dB (AGC off) 	<ul style="list-style-type: none"> ▪ 12x optical zoom ▪ Fixed length: 3.8 to 45.6 mm ▪ Aperture: F1.6 to F2.7 ▪ Angle of view: (H) 4.49° to 52.8° (V) 3.40° to 39.7° (D) 55.4° to 65.4°
	PTZ Hardware Profile	<ul style="list-style-type: none"> ▪ Pan travel: 360° endless ▪ Tilt travel: 10° to 170° ▪ Manual speed: 1° to 80°/second ▪ Presets: 256 points ▪ Preset Accuracy: 0.225° ▪ Preset Speed: 10° to 400°/second ▪ Sequence Paths: 8 ▪ Auto Pan Paths: 4 ▪ Cruise Paths: 8 	<ul style="list-style-type: none"> ▪ Pan and tilt speed proportional to zoom ratio ▪ Resume after power loss ▪ Home Functions: Preset, Sequence, Auto Pan, Cruise ▪ Auto Flip: Mechanical/Digital/Off ▪ Digital Slow Shutter ▪ Image Freeze ▪ Image Inverse
	Image Features	<ul style="list-style-type: none"> ▪ Configurable image size, quality, frame rate, and bit rate ▪ Time stamp and text overlays ▪ Configurable motion detection windows 	<ul style="list-style-type: none"> ▪ 16 configurable privacy masks ▪ Configurable white balance, shutter speed, brightness, saturation, contrast, sharpness
	Video Compression	<ul style="list-style-type: none"> ▪ Simultaneous H.264/MPEG-4/MJPEG format compression ▪ JPEG for still image 	<ul style="list-style-type: none"> ▪ H.264/MPEG-4 multicast streaming
	Video Resolution	<ul style="list-style-type: none"> ▪ NTSC: 720 x 480, 352 x 240, 176 x 120 at up to 30 fps ▪ PAL: 720 x 576, 352 x 288, 176 x 144 at up to 25 fps 	
	Audio Support	G.726	
	External Device Interface	<ul style="list-style-type: none"> ▪ 10/100 BASE-TX Ethernet port ▪ 8 Alarm inputs ▪ 1 Alarm outputs 	<ul style="list-style-type: none"> ▪ Audio input / output ▪ Video output
Network	Network Protocols	IPv4, TCP/IP, UDP, ICMP, DHCP Client, NTP Client (D-Link), DNS Client, DDNS Client (D-Link), SMTP Client, FTP Client, HTTP / HTTPS, Samba Client, PPPoE, UPnP Port Forwarding, RTP / RTSP / RTCP, IP Itering, 3GPP, IGMP, ONVIF Compliant	
	Security	<ul style="list-style-type: none"> ▪ Administrator and user group protection ▪ Password authentication 	<ul style="list-style-type: none"> ▪ HTTP and RTSP digest encryption

System Management	System Requirements for Web Interface	<ul style="list-style-type: none"> ▪ Operating system: Microsoft Windows 7/Vista/XP/2000 ▪ Browser: Internet explorer, Firefox, Netscape, Mozilla, Opera
	Event Management	<ul style="list-style-type: none"> ▪ Motion detection ▪ Event notification and upload snapshots/video clips via HTTP, SMTP or FTP ▪ Supports multiple HTTP, SMTP and FTP servers ▪ Multiple event notification ▪ Multiple recording methods for easy backup
	Remote Management	<ul style="list-style-type: none"> ▪ Configuration accessible via web browser ▪ Take snapshots/video clips and save to local hard drive or NAS via web browser
	Mobile Support	Windows 7/Vista/XP system, Pocket PC, or mobile phone with 3GPP playback support
	D-ViewCam™ System Requirements	<ul style="list-style-type: none"> ▪ Operating System: Microsoft Windows 7 / Vista / XP ▪ Web Browser: Internet Explorer 6 or higher ▪ Protocol: Standard TCP/IP
	D-ViewCam™ Software Functions	<ul style="list-style-type: none"> ▪ Remote management/control of up to 32 cameras ▪ Viewing of up to 32 cameras on one screen ▪ Supports all management functions provided in web interface ▪ Scheduled motion triggered, or manual recording options
General	Power Input	DC 12 V / 2A
	Max. Power Consumption	14 W
	Operating Temperature	0° to 40° C (32° to 104° F)
	Storage Temperature	-20° to 70° C (-4° to 158° F)
	Humidity	20% to 80% non-condensing
	Weight	1.2 kg (2.6 lbs)
	Certifications	CE (Class A), CE LVD (EN60965-1), FCC (Class A), ICES-003, C-Tick

Dimensions

