

6. Wireless Volume Control

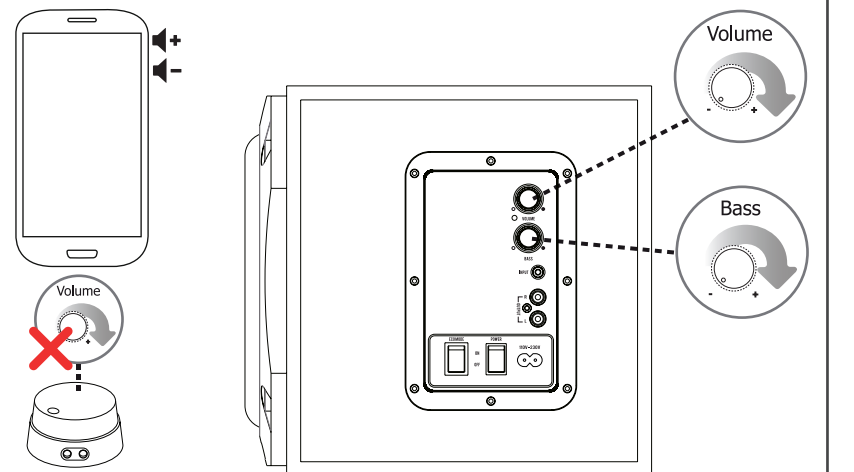

7. Other Connections

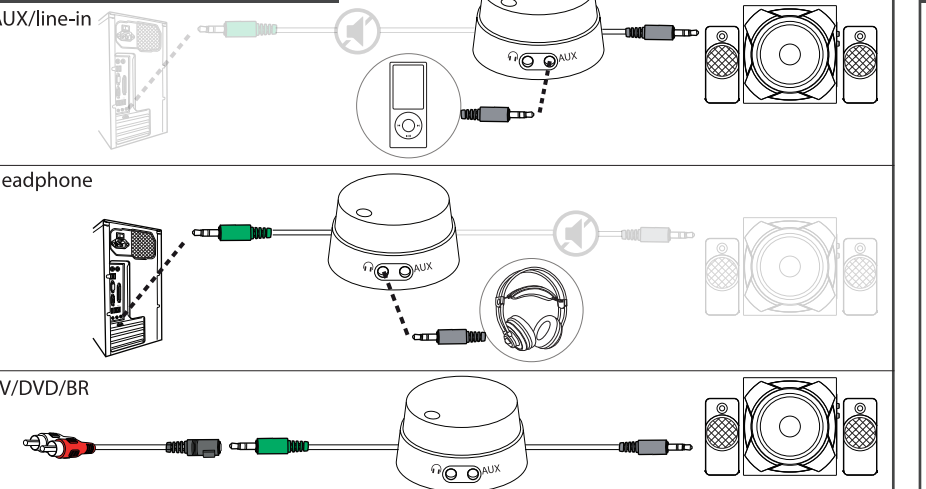

8. Installation Windows 10/8/7

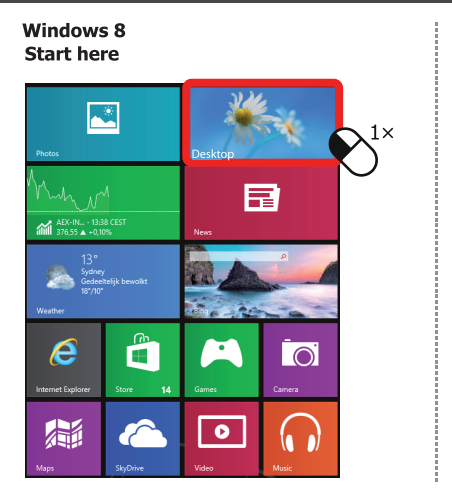

9. ECO Mode

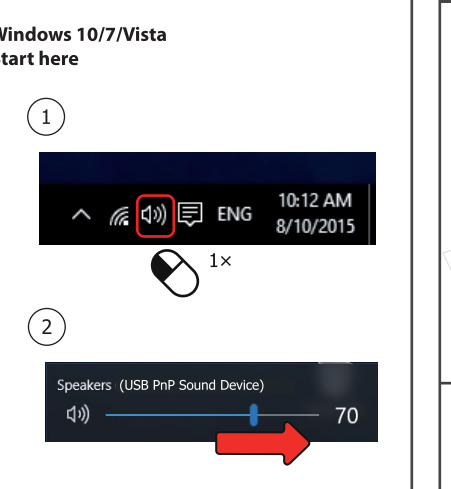

Frequently Asked Questions

www.trust.com/21243/faq

© 2017 Trust International B.V. - All rights reserved - Laan van Barcelona 600 - 3317DD - Dordrecht - NL

Trust

BLUETOOTH

2.1 Speaker set

Quick Installation Guide



1. Setup

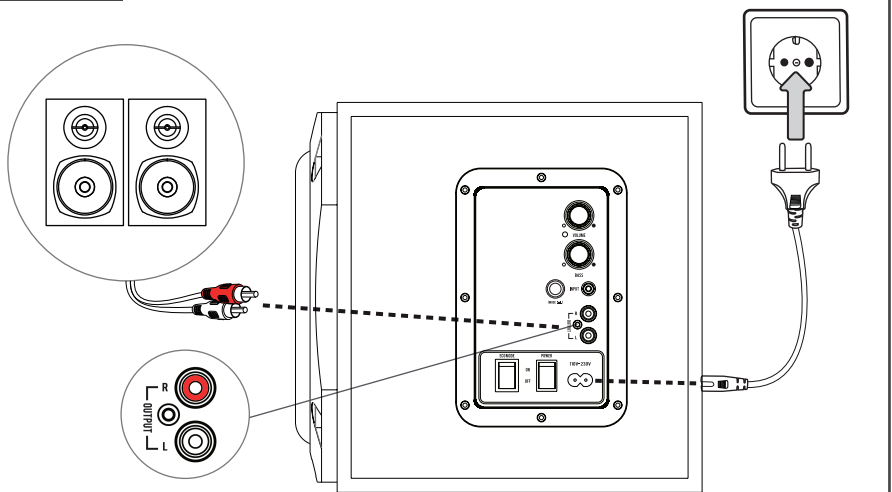

2. Wireless Setup 1/2

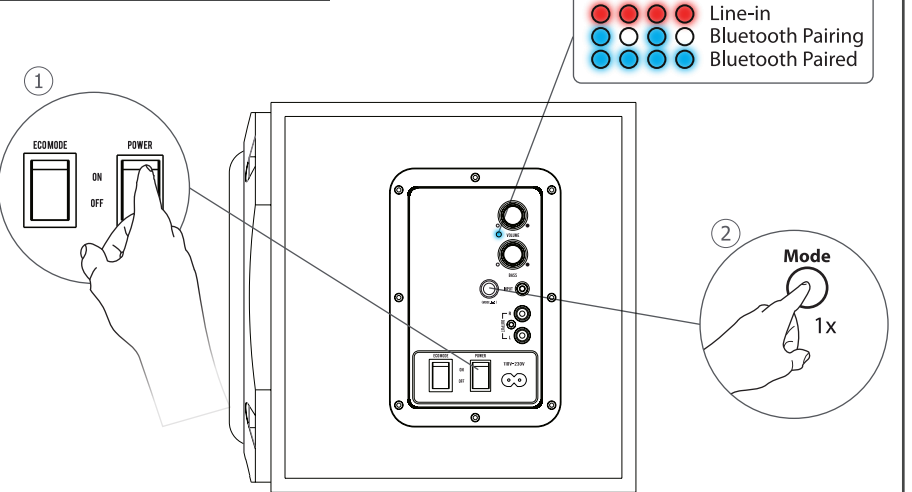

3. Wireless Setup 2/2

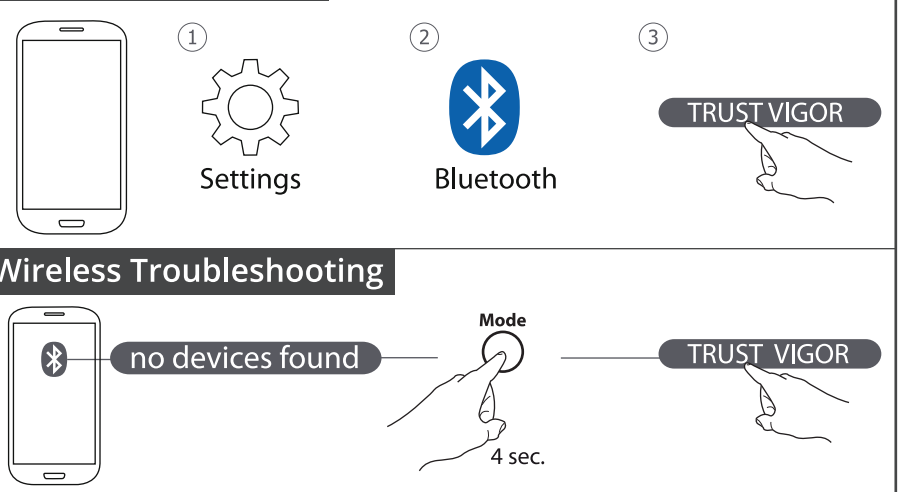

4. Wired Setup

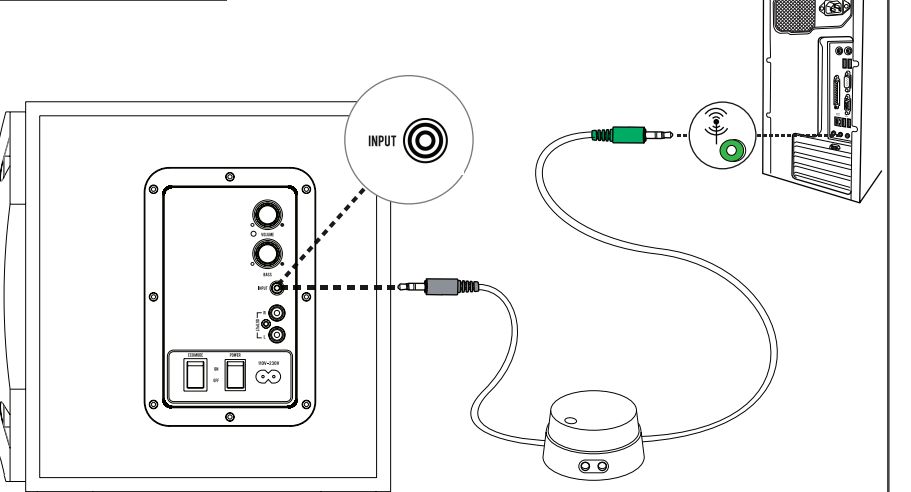

5. Volume Control

