

User Guide

DSL-AC51

**Wireless-AC750
Dual-band Wi-Fi VDSL/ADSL
Modem Router**



E12787

First Edition

July 2017

Copyright © 2017 ASUSTeK Computer Inc. All Rights Reserved.

No part of this manual, including the products and software described in it, may be reproduced, transmitted, transcribed, stored in a retrieval system, or translated into any language in any form or by any means, except documentation kept by the purchaser for backup purposes, without the express written permission of ASUSTeK Computer Inc. ("ASUS").

Product warranty or service will not be extended if: (1) the product is repaired, modified or altered, unless such repair, modification or alteration is authorized in writing by ASUS; or (2) the serial number of the product is defaced or missing.

ASUS PROVIDES THIS MANUAL "AS IS" WITHOUT WARRANTY OF ANY KIND, EITHER EXPRESS OR IMPLIED, INCLUDING BUT NOT LIMITED TO THE IMPLIED WARRANTIES OR CONDITIONS OF MERCHANTABILITY OR FITNESS FOR A PARTICULAR PURPOSE. IN NO EVENT SHALL ASUS, ITS DIRECTORS, OFFICERS, EMPLOYEES OR AGENTS BE LIABLE FOR ANY INDIRECT, SPECIAL, INCIDENTAL, OR CONSEQUENTIAL DAMAGES (INCLUDING DAMAGES FOR LOSS OF PROFITS, LOSS OF BUSINESS, LOSS OF USE OR DATA, INTERRUPTION OF BUSINESS AND THE LIKE), EVEN IF ASUS HAS BEEN ADVISED OF THE POSSIBILITY OF SUCH DAMAGES ARISING FROM ANY DEFECT OR ERROR IN THIS MANUAL OR PRODUCT.

SPECIFICATIONS AND INFORMATION CONTAINED IN THIS MANUAL ARE FURNISHED FOR INFORMATIONAL USE ONLY, AND ARE SUBJECT TO CHANGE AT ANY TIME WITHOUT NOTICE, AND SHOULD NOT BE CONSTRUED AS A COMMITMENT BY ASUS. ASUS ASSUMES NO RESPONSIBILITY OR LIABILITY FOR ANY ERRORS OR INACCURACIES THAT MAY APPEAR IN THIS MANUAL, INCLUDING THE PRODUCTS AND SOFTWARE DESCRIBED IN IT.

Products and corporate names appearing in this manual may or may not be registered trademarks or copyrights of their respective companies, and are used only for identification or explanation and to the owners' benefit, without intent to infringe.

Table of contents

1	Getting to know your xDSL modem router	
1.1	Welcome!	6
1.2	Package contents	6
1.3	Your xDSL modem router	7
1.4	Positioning your xDSL modem router	9
1.5	Setup Requirements	10
1.6	xDSL Modem Router Setup	11
	1.6.1 Wired connection.....	11
	1.6.2 Wireless connection	12
2	Getting started	
2.1	Logging into the Web GUI	13
2.2	Quick Internet Setup (QIS) Wizard with Auto-detection	14
2.3	Connecting to your wireless network.....	18
3	Configuring the General settings	
3.1	Using the Network Map	19
	3.1.1 Setting up the wireless security settings.....	20
	3.1.2 Managing your network clients.....	21
3.2	Creating a Guest Network.....	22
3.3	Using the Traffic Manager	24
	3.3.1 Managing QoS (Quality of Service) Bandwidth.....	24
	3.3.2 Monitoring Traffic	27
	3.3.3 Spectrum	28
3.4	Setting up Parental Control	29
4	Configuring the Advanced Settings	
4.1	Wireless.....	30
	4.1.1 General.....	30
	4.1.2 WPS	33

Table of contents

4.1.3	Bridge	35
4.1.4	Wireless MAC Filter	37
4.1.5	RADIUS Setting	38
4.1.6	Professional	39
4.2	LAN	41
4.2.1	LAN IP	41
4.2.2	DHCP Server	42
4.2.3	Route	44
4.2.4	IPTV	45
4.3	WAN	46
4.3.1	Internet Connection	46
4.3.2	Dual WAN	48
4.3.3	Port Trigger	49
4.3.4	Virtual Server/Port Forwarding	51
4.3.5	DMZ	54
4.3.6	DDNS	55
4.3.7	NAT Passthrough	56
4.4	IPv6	57
4.5	VPN Server	58
4.6	Firewall	59
4.6.1	General	59
4.6.2	URL Filter	59
4.6.3	Keyword Filter	60
4.6.4	Network Services Filter	61
4.7	Administration	62
4.7.1	System	62
4.7.2	Firmware Upgrade	63
4.7.3	Restore/Save/Upload Setting	63
4.7.4	DSL Setting	64
4.7.5	Feedback	67

Table of contents

4.8	System Log	68
5	Utilities	
5.1	Device Discovery	69
5.2	Firmware Restoration	70
6	Troubleshooting	
6.1	Basic Troubleshooting	72
6.2	Frequently Asked Questions (FAQs)	75
	Appendices	
	Notices	84
	ASUS Contact information	98
	Networks Global Hotline Information.....	99

1 Getting to know your xDSL modem router

1.1 Welcome!

Thank you for purchasing an ASUS Wireless VDSL/ADSL Modem Router!

The stylish modem router features 2.4GHz and 5GHz dual bands for an unmatched concurrent wireless HD streaming; operates as a router on an ADSL or VDSL line; SMB server, UPnP AV server, and FTP server for 24/7 file sharing; and capability to handle 300,000 sessions. These features make this xDSL modem router a good choice for complete home networking.

1.2 Package contents

- VDSL/ADSL Wireless Modem Router
- Network cable (RJ-45 cable)
- Splitter (varies with region)
- Power adapter
- Quick Start Guide
- DSL/phone cable (RJ-11 cable)
- Warranty card

NOTES:

- If any of the items are damaged or missing, contact ASUS for technical inquiries and support. Refer to the ASUS Support Hotline list at the back of this user manual.
 - Keep the original packaging material in case you would need future warranty services such as repair or replacement.
-

1.3 Your xDSL modem router

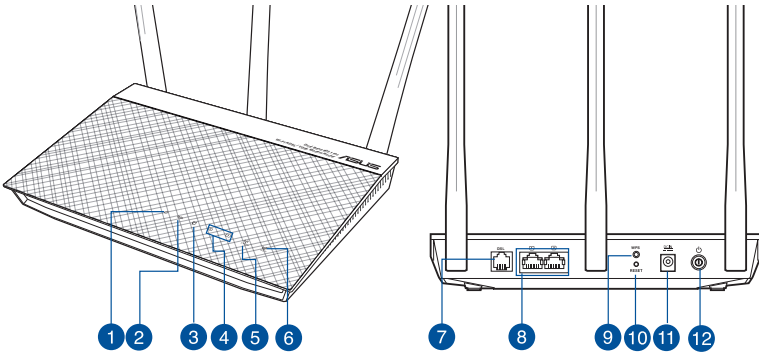

-
- 1 Power LED**
Off: No power.
On: Device is ready.
Flashing slow: Rescue mode
Flashing quick: WPS is processing.

 - 2 DSL LED**
Off: No DSL link or unable to establish DSL link.
On: DSL link is established.
Flashing: DSL is attempting to connect to a DSLAM.

 - 3 Internet LED**
Off: No power or no physical connection.
On: Has physical connection to a wide area network (WAN).

 - 4 LAN 1~2 LED**
Off: No power or no physical connection.
On: Has physical connection to an Ethernet network.

 - 5 2.4GHz LED**
Off: No 2.4GHz signal.
On: Wireless system is ready.
Flashing: Transmitting or receiving data via wireless connection.

 - 6 5GHz LED**
Off: No 5GHz signal.
On: Wireless system is ready.
Flashing: Transmitting or receiving data via wireless connection.

 - 7 DSL port**
Connect to a splitter or to a telephone outlet via an RJ-11 cable.
-

8

LAN 1 ~ 2 ports

Connect network cables into these ports to establish LAN connection.

9

WPS button

Press this button to launch the WPS Wizard.

10

Reset button

This button resets or restores the system to its factory default settings.

11

Power (DC-IN) port

Insert the bundled AC adapter into this port and connect your router to a power source.

12

Power button

Press this button to power on or off the system.

NOTES:

- Use only the adapter that came with your package. Using other adapters may damage the device.
- **Specifications:**
 - The average power consumption is determined at room temperatures with the following load:

DC Power adapter	DC Output: +12V with max. 1A current		
Operating Temperature	0~40°C	Storage	0~70°C
Operating Humidity	50~90%	Storage	20~90%

1.4 Positioning your xDSL modem router

For the best wireless signal transmission between the xDSL modem router and the network devices connected to it, ensure that you:

- Place the xDSL modem router in a centralized area for a maximum wireless coverage for the network devices.
- Keep the device away from metal obstructions and away from direct sunlight.
- To prevent signal interference or loss, keep the device away from 802.11g or 20MHz only Wi-Fi devices, 2.4GHz computer peripherals, Bluetooth devices, cordless phones, transformers, heavy-duty motors, fluorescent lights, microwave ovens, refrigerators, and other industrial equipment.
- Always update to the latest firmware. Visit the ASUS website at <http://www.asus.com> to get the latest firmware updates.
- To ensure the best wireless signal, orient the four detachable antennas as shown in the drawing below.

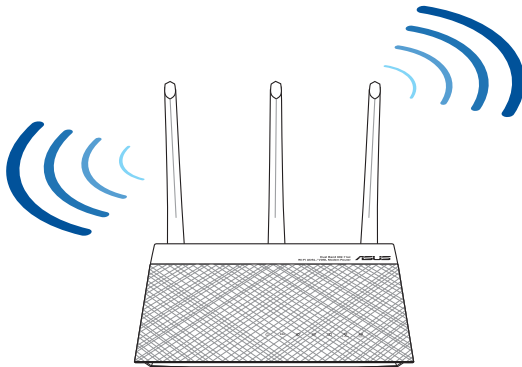

1.5 Setup Requirements

To set up your wireless network, you need a computer that meets the following system requirements:

- Ethernet RJ-45 (LAN) port
- IEEE 802.11a/b/g/n/ac wireless capability
- An installed TCP/IP service
- Web browser such as Internet Explorer, Firefox, Safari, or Google Chrome

NOTES:

- If your computer does not have built-in wireless capabilities, you may install an IEEE 802.11a/b/g/n/ac WLAN adapter to your computer to connect to the network.
 - With its dual band technology, your ADSL/VDSL router supports 2.4GHz and 5GHz wireless signals simultaneously. This allows you to browse the Internet or access e-mail messages using the 2.4GHz band while streaming high-definition audio/video files such as movies or music using the 5GHz band.
 - If you are using only one computer with a single band IEEE 802.11a/b/g/n/ac WLAN adapter, you will only be able to use the 2.4GHz band.
 - If you are using only one computer with a dual band IEEE 802.11a/b/g/n/ac WLAN adapter, you will be able to use the 2.4GHz or 5GHz band.
 - If you are using two computers with both IEEE 802.11a/b/g/n/ac WLAN adapters, you will be able to use both 2.4GHz and 5GHz bands simultaneously.
 - The Ethernet RJ-45 cables that will be used to connect the network devices should not exceed 100 meters.
-

1.6 xDSL Modem Router Setup

IMPORTANT!

- Use a wired connection when setting up your xDSL modem router to avoid possible setup problems.
- Before setting up your ASUS xDSL modem router, do the following:
 - If you are replacing an existing xDSL modem router, disconnect it from your network.

1.6.1 Wired connection

NOTE: You can use either a straight-through cable or a crossover cable for wired connection.

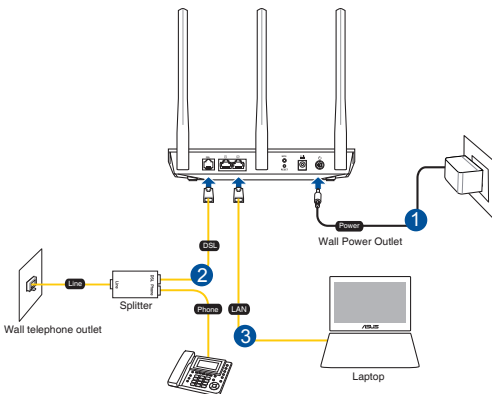

To set up your xDSL modem router via wired connection:

1. Insert your xDSL modem router's power adapter to the DC-IN port and plug it to a power outlet.
2. Connect one end of the RJ-11 cable to the DSL port of your xDSL modem router, and connect the other end to the DSL port of your splitter.
3. Using a network cable, connect your computer to your xDSL modem router's LAN port.

IMPORTANT! After turning on your xDSL modem router, wait for about two to three minutes for it to boot up.

1.6.2 Wireless connection

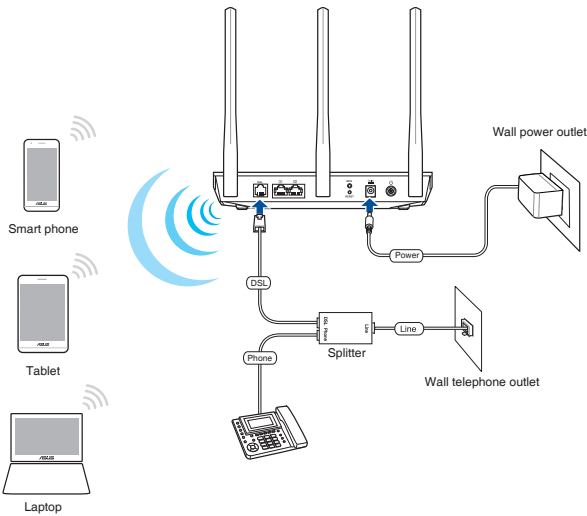

To set up your xDSL modem router via wireless connection:

1. Insert your xDSL modem router's power adapter to the DC-IN port and plug it to a power outlet.
2. Connect one end of the RJ-11 cable to the DSL port of your xDSL modem router, and connect the other end to the DSL port of your splitter.
3. Install an IEEE 802.11a/b/g/n/ac WLAN adapter on your computer.

NOTES:

- For details on connecting to a wireless network, refer to the WLAN adapter's user manual.
 - To set up the security settings for your network, refer to the section **Setting up the wireless security settings** in Chapter 3 of this user manual.
-

2 Getting started

2.1 Logging into the Web GUI

Your ASUS Wireless xDSL Modem Router comes with an intuitive web graphical user interface (GUI) that allows you to easily configure its various features through a web browser such as Internet Explorer, Firefox, Safari, or Google Chrome.

NOTE: The features may vary with different firmware versions.

To log into the web GUI:

1. The web GUI launches automatically when you open a web browser. If it does not auto-launch, enter <http://router.asus.com>
2. Set up a password for your router to prevent unauthorized access.

NOTE: Disable the proxy settings, dial-up connection, and set your TCP/IP settings to automatically obtain an IP address. For more details, please refer to the ASUS Support site: <https://www.asus.com/Networking/DSL-AC51/HelpDesk/>.

3. You can now use the Web GUI to configure various settings of your ASUS XDSL modem router.



NOTE: If you are logging into the Web GUI for the first time, you will be directed to the Quick Internet Setup (QIS) page automatically.

2.2 Quick Internet Setup (QIS) Wizard with Auto-detection

The Quick Internet Setup (QIS) function guides you in quickly setting up your Internet connection.

NOTE: When setting the Internet connection for the first time, press the Reset button on your xDSL modem router to reset it to its factory default settings. For more details, refer to the section **Firmware Restoration** in Chapter 5 of this user manual.

To use QIS with auto-detection:

1. Log into the Web GUI. The QIS page launches automatically.

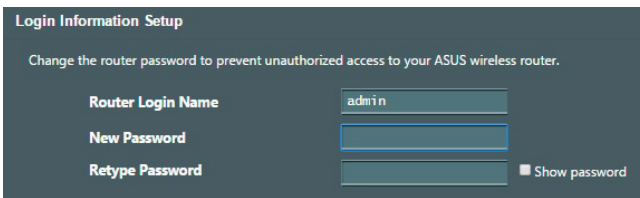

Login Information Setup

Change the router password to prevent unauthorized access to your ASUS wireless router.

Router Login Name:

New Password:

Retype Password: Show password

NOTE: The xDSL modem router's login username and password is different from the 2.4GHz/5GHz network name (SSID) and security key. The xDSL modem router's login username and password allows you to log into Web GUI to configure your wireless router's settings. The 2.4GHz/5GHz network name (SSID) and security key allows Wi-Fi devices to log in and connect to your 2.4GHz/5GHz network.

2. Your xDSL modem router automatically configures the DSL Annex mode, Internet connection type, and VPI/VCI value and encapsulation modes. Key in the Internet account information from your Internet Service Provider (ISP).

IMPORTANT! Obtain the necessary information from your ISP to configure the Internet connection.

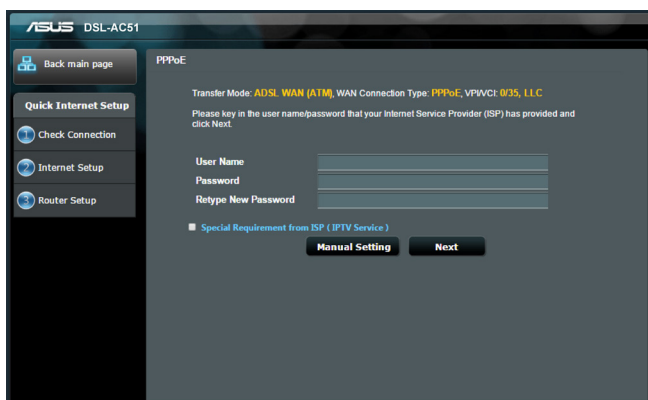

NOTES:

- The auto-detection of your ISP connection type takes place when you configure your xDSL modem router for the first time or when your device is reset to its default settings.
 - By default, the QIS Wizard is for DSL setup. If you want to configure the modem as a wireless router, refer to the section **Internet Connection** in Chapter 4 of this user manual.
-

3. If QIS failed to detect your Internet connection type, follow the steps below to manually configure your connection settings:
 - a) Select the Annex mode that your DSL service uses.

NOTES:

- Annex A or Annex B mode has multiple modes: Annex A/I/J/L/M or Annex B/J. If your ISP DSLAM offers both Annex A and Annex M mode, QIS automatically set the Annex mode to Annex A/I/J/L/M mode and completes the DSL line setting.
 - If you want to configure your ASUS xDSL modem router to a specific Annex mode, refer to the section **DSL Setting** in Chapter 4 of this user guide.
-

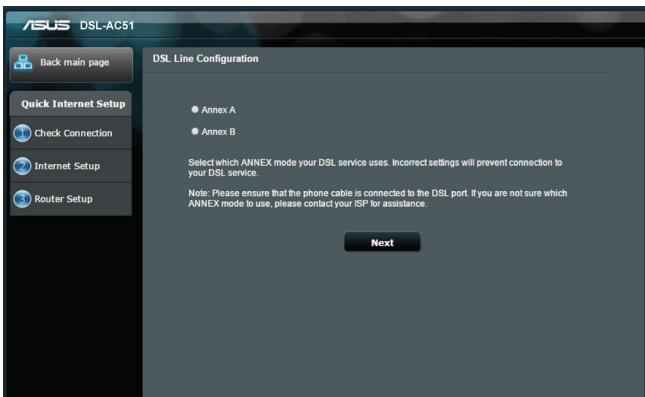

b) Select your **Country** and **Internet Service Provider (ISP)**.

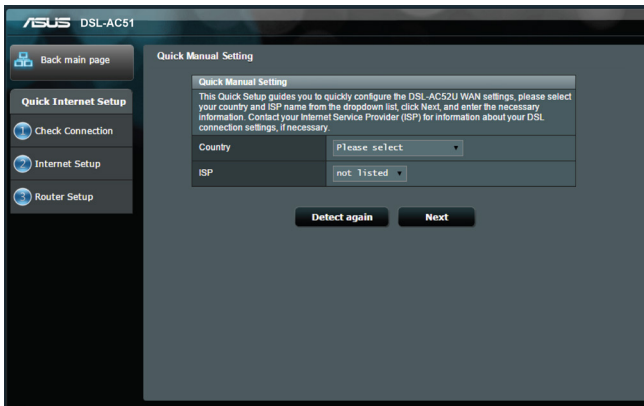

c) Assign the wireless network name (SSID) and security key for your wireless connection. Click **Apply** when done.

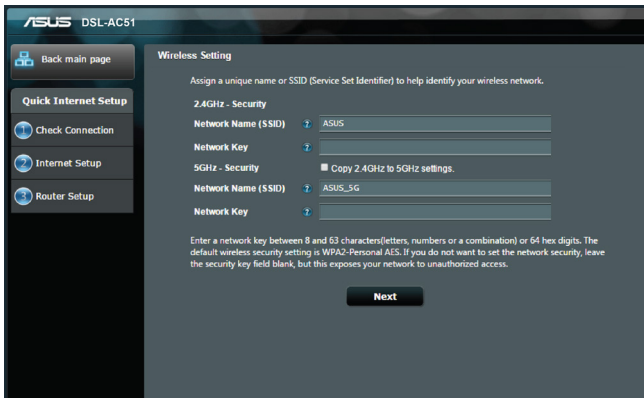

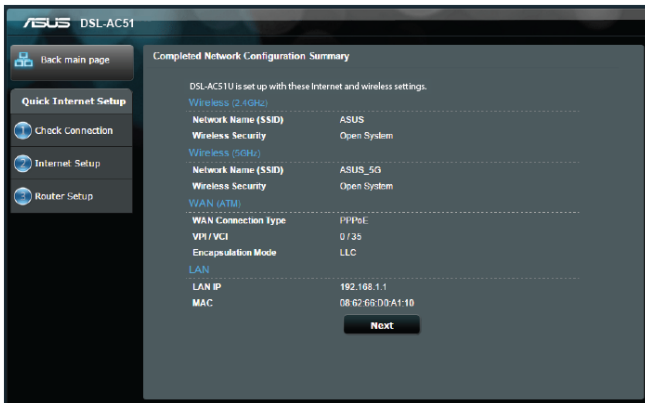

d) A summary page appears to show the current settings for your network. Click **Next** to save your network settings and go to the Network Map page.



2.3 Connecting to your wireless network

After setting up your xDSL modem router via QIS, you can connect your computer or other smart devices to your wireless network.

To connect to your network:

1. On your computer, click the network icon  in the notification area to display the available wireless networks.
2. Select the wireless network that you want to connect to, then click **Connect**.
3. You may need to key in the network security key for a secured wireless network, then click **OK**.
4. Wait while your computer establishes connection to the wireless network successfully. The connection status is displayed and the network icon displays the connected  status.

NOTE: Refer to the next chapters for more details on configuring your wireless network's settings.

3 Configuring the General settings

3.1 Using the Network Map

Network Map allows you to configure your network's security settings, and manage your network clients.



3.1.1 Setting up the wireless security settings

To protect your wireless network from unauthorized access, you need to configure its security settings.

To set up the wireless security settings:

1. From the navigation panel, go to **General > Network Map**.
2. On the Network Map screen and under **System status**, you can configure the wireless security settings such as SSID, security level, and encryption settings.

NOTE: You can set up different wireless security settings for 2.4GHz and 5GHz bands.

2.4GHz security settings

The screenshot shows the 'System Status' configuration page for the 2.4GHz band. At the top, there are two tabs: '2.4GHz' (selected) and '5GHz'. Below the tabs, the 'Wireless name(SSID)' field contains 'ASUS'. The 'Authentication Method' dropdown is set to 'Open System'. The 'WEP Encryption' dropdown is set to 'None'. An 'Apply' button is located below these settings. The bottom section of the screen displays LAN IP (192.168.1.1), PIN code (72013502), LAN MAC address (10:BF:48:D8:49:78), and Wireless 2.4GHz MAC address (10:BF:48:D8:49:78).

5GHz security settings

The screenshot shows the 'System Status' configuration page for the 5GHz band. At the top, there are two tabs: '2.4GHz' and '5GHz' (selected). Below the tabs, the 'Wireless name(SSID)' field contains 'ASUS_5G'. The 'Authentication Method' dropdown is set to 'Open System'. The 'WEP Encryption' dropdown is set to 'None'. An 'Apply' button is located below these settings. The bottom section of the screen displays LAN IP (192.168.1.1), PIN code (72013502), LAN MAC address (10:BF:48:D8:49:78), and Wireless 5GHz MAC address (10:BF:48:D8:49:7C).

3. On the **Wireless name (SSID)** field, key in a unique name for your wireless network.
4. From the **Authentication Method** dropdown list, select the encryption method for your wireless network.

IMPORTANT! The IEEE 802.11n/ac standard prohibits using High Throughput with WEP or WPA-TKIP as the unicast cipher. If you use these encryption methods, your data rate will drop to IEEE 802.11g 54Mbps connection.

5. Key in your **WPA-PSK key** (security passkey).
6. Click **Apply** when done.

3.1.2 Managing your network clients



To manage your network clients:

1. From the navigation panel, go to **General > Network Map** tab.
2. On the Network Map screen, select the **Client Status** icon to display your network client's information.

3.2 Creating a Guest Network

The Guest Network provides temporary visitors with Internet connectivity via access to separate SSIDs or networks without providing access to your private network.

NOTE: ASUS DSL-AC51 supports up to six SSIDs (including the main SSID).

To create a guest network:

1. From the navigation panel, go to **General > Guest Network**.
2. On the Guest Network screen, select 2.4GHz or 5GHz frequency band for the guest network that you want to create.
3. Click **Enable**.

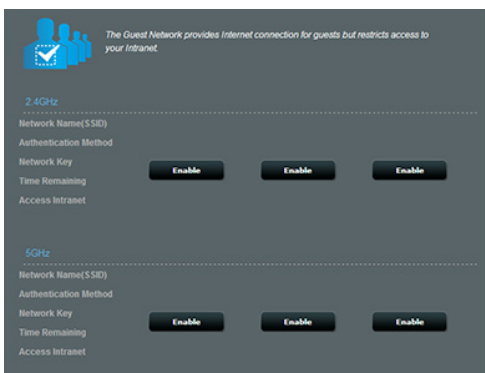

4. To configure additional options, click **Modify**.

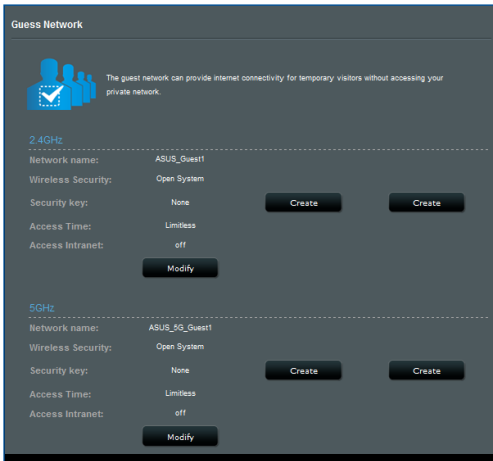

5. Click **Yes** on the **Enable Guest Network** screen.
6. Assign a wireless name for your temporary network on the **Network Name (SSID)** field.
7. Select an **Authentication Method**.
8. Select an **Encryption** method.
9. Specify the **Access time** or choose **Limitless**.
10. Select **Disable** or **Enable** on the **Access Intranet** item.
11. When done, click **Apply**.

3.3 Using the Traffic Manager

3.3.1 Managing QoS (Quality of Service) Bandwidth

Quality of Service (QoS) allows you to set the bandwidth priority and manage network traffic.

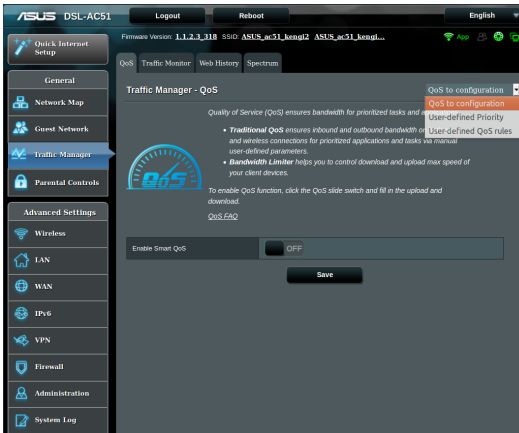

To set up bandwidth priority:

1. From the navigation panel, go to **General > Traffic Manager > QoS** tab.
2. Click **ON** to enable QoS. Fill in the upload and download bandwidth fields.

NOTE: Get the bandwidth information from your ISP.

3. Click **Save**.

NOTE: The User Specify Rule List is for advanced settings. If you want to prioritize specific network applications and network services, select **User-defined QoS rules** or **User-defined Priority** from the drop-down list on the upper-right corner.

4. On the **user-defined QoS rules** page, there are four default online service types – web surf, HTTPS and file transfers. Select your preferred service, fill in the **Source IP or MAC, Destination Port, Protocol, Transferred** and **Priority**, then click **Apply**. The information will be configured in the QoS rules screen.

NOTES:

- To fill in the source IP or MAC, you can:
 - a) Enter a specific IP address, such as "192.168.122.1".
 - b) Enter IP addresses within one subnet or within the same IP pool, such as "192.168.123.*", or "192.168.*.*"
 - c) Enter all IP addresses as "*.*.*.*" or leave the field blank.
 - d) The format for the MAC address is six groups of two hexadecimal digits, separated by colons (:), in transmission order (e.g. 12:34:56:aa:bc:ef)

NOTES:

- For source or destination port range, you can either:
 - a) Enter a specific port, such as "95".
 - b) Enter ports within a range, such as "103:315", ">100", or "<65535".
- The **Transferred** column contains information about the upstream and downstream traffic (outgoing and incoming network traffic) for one section. In this column, you can set the network traffic limit (in KB) for a specific service to generate specific priorities for the service assigned to a specific port. For example, if two network clients, PC 1 and PC 2, are both accessing the Internet (set at port 80), but PC 1 exceeds the network traffic limit due to some downloading tasks, PC 1 will have a lower priority. If you do not want to set the traffic limit, leave it blank.

5. On the **User-defined Priority** page, you can prioritize the network applications or devices into five levels from the **user-defined QoS rules**' dropdown list. Based on priority level, you can use the following methods to send data packets:
 - Change the order of upstream network packets that are sent to the Internet.
 - Under **Upload Bandwidth** table, set **Minimum Reserved Bandwidth** and **Maximum Bandwidth Limit** for multiple network applications with different priority levels. The percentages indicate the upload bandwidth rates that are available for specified network applications.

NOTES:

- Low-priority packets are disregarded to ensure the transmission of high-priority packets.
- Under **Download Bandwidth** table, set **Maximum Bandwidth Limit** for multiple network applications in corresponding order. The higher priority upstream packet will cause the higher priority downstream packet.
- If there are no packets being sent from high-priority applications, the full transmission rate of the Internet connection is available for low-priority packets.

-
6. Set the highest priority packet. To ensure a smooth online gaming experience, you can set ACK, SYN, and ICMP as the highest priority packet.

NOTE: Ensure to enable QoS first and set up the upload and download rate limits.

3.3.2 Monitoring Traffic

The traffic monitor function allows you to access the bandwidth usage and speed of your Internet, wired, and wireless networks. It allows you to monitor network traffic even on a daily basis.

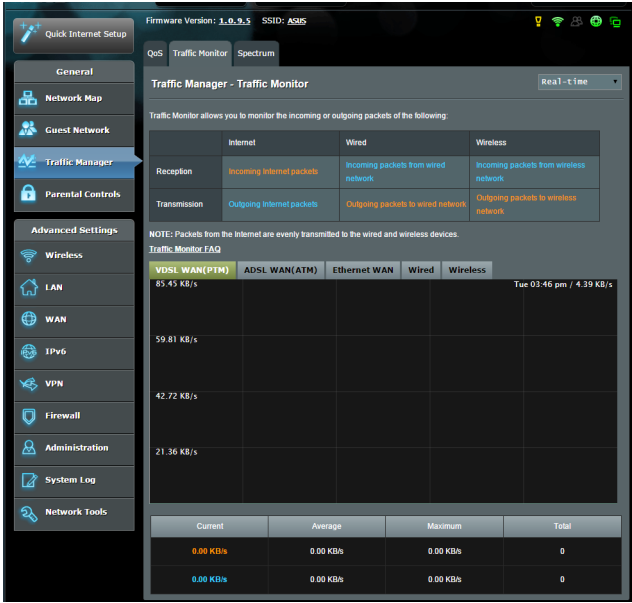

NOTE: Packets from the Internet are evenly transmitted to the wired and wireless devices.

3.3.3 Spectrum

DSL Spectrum provide information on the connection quality. The graph to signal-to-noise ratio shows the classic SNR (Signal-to-Noise Ratio), which can be useful in identifying the stability of the DSL connection. Transmission/Reception graph shows how many bits per carrier are transmitted/received.



3.4 Setting up Parental Control

Parental Control allows you to control the Internet access time. Users can set the time limit for a client's network usage.

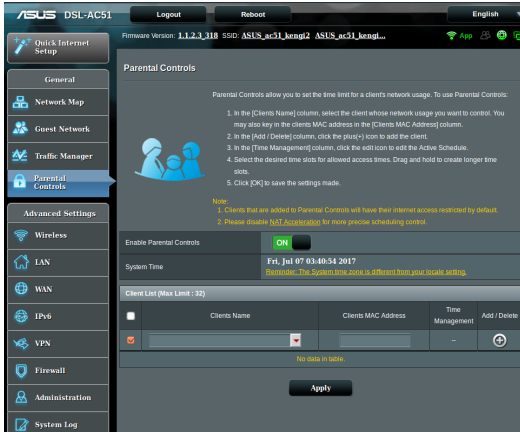

To use the parental control function:

1. From the navigation panel, go to **General > Parental Controls**.
2. Click **Enable Parental Controls** to **ON** to activate Parental Control.
3. Select the client whose network usage you want to control. You may also key in the client's MAC address in the **Client MAC Address** column.

NOTE: Ensure that the client name does not contain special characters or spaces as this may cause the router to function abnormally.

4. Click or to add or delete the client's profile.
5. Set up the allowed time limit in **Time Management** map. Drag and drop a desired time zone to allow client's network usage.
6. Click **OK**.
7. Click **Apply** to save the settings.

4 Configuring the Advanced Settings

4.1 Wireless

4.1.1 General

The General tab allows you to configure the basic wireless settings.

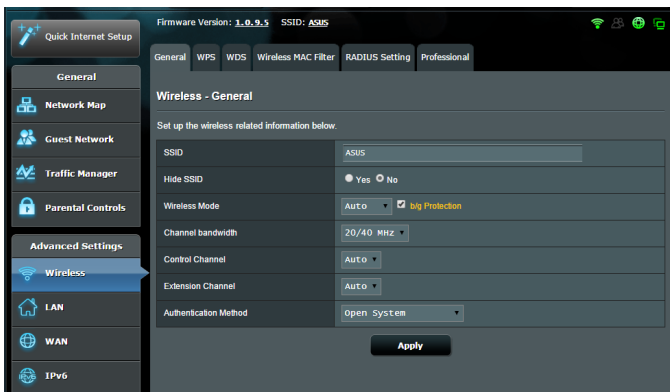

To configure the basic wireless settings:

1. From the navigation panel, go to **Advanced Settings > Wireless > General** tab.
2. Select 2.4GHz or 5GHz as the frequency band for your wireless network.
3. Assign a unique name containing up to 32 characters for your SSID (Service Set Identifier) or network name to identify your wireless network. Wi-Fi devices can identify and connect to the wireless network via your assigned SSID. The SSIDs on the information banner are updated once new SSIDs are saved to the settings.

NOTE: You can assign unique SSIDs for the 2.4 GHz and 5GHz frequency bands.

4. In the **Hide SSID** field, select **Yes** to prevent wireless devices from detecting your SSID. When this function is enabled, you would need to enter the SSID manually on the wireless device to access the wireless network.
5. Select any of these wireless mode options to determine the types of wireless devices that can connect to your xDSL modem router:
 - **Auto**: Select **Auto** to allow 802.11ac, 802.11n, 802.11g, and 802.11b devices to connect to the xDSL modem router.
 - **Legacy**: Select **Legacy** to allow 802.11b/g/n devices to connect to the xDSL modem router. Hardware that supports 802.11n natively, however, will only run at a maximum speed of 54Mbps.
 - **N only**: Select **N only** to maximize wireless N performance. This setting prevents 802.11g and 802.11b devices from connecting to the xDSL modem router.
6. Select the operating channel for your xDSL modem router. Select **Auto** to allow the xDSL modem router to automatically select the channel that has the least amount of interference.
7. Select any of these channel bandwidth to accommodate higher transmission speeds:
 - 40MHz**: Select this bandwidth to maximize the wireless throughput.
 - 20/40MHz**: This is the default bandwidth.
 - 20MHz**: Select this bandwidth if you encounter some issues with your wireless connection.
8. Select any of these authentication methods:
 - **Open System**: This option provides no security.
 - **WPA/WPA2 Personal/WPA Auto-Personal**: This option provides strong security. You can use either WPA (with TKIP) or WPA2 (with AES). If you select this option, you must use TKIP + AES encryption and enter the WPA passphrase (network key).

- **WPA/WPA2 Enterprise/WPA Auto-Enterprise:** This option provides very strong security. It is with integrated EAP server or an external RADIUS back-end authentication server.

NOTE: Your xDSL modem router supports the maximum transmission rate of 54Mbps when the **Wireless Mode** is set to **Auto** and **encryption method** is **WEP** or **TKIP**.

9. Select any of these WEP (Wired Equivalent Privacy) Encryption options for the data transmitted over your wireless network:
 - **Off:** Disables WEP encryption
 - **64-bit:** Enables weak WEP encryption
 - **128-bit:** Enables improved WEP encryption.
10. When done, click **Apply**.

4.1.2 WPS

WPS (Wi-Fi Protected Setup) is a wireless security standard that allows you to easily connect devices to a wireless network. You can configure the WPS function via the PIN code or WPS button.

NOTE: Ensure that the devices support WPS.

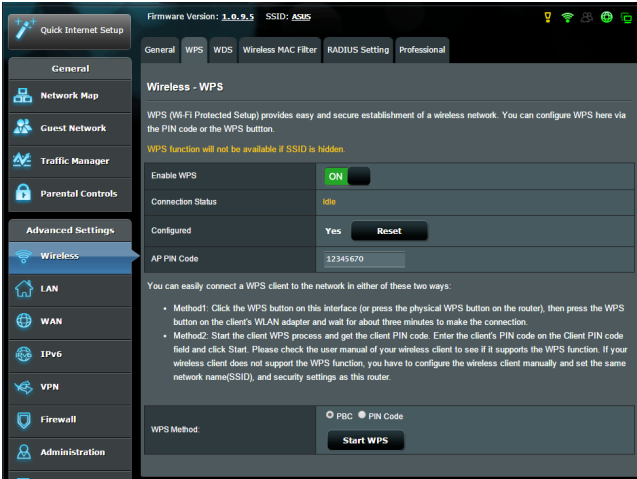

To enable WPS on your wireless network:

1. From the navigation panel, go to **Advanced Settings > Wireless > WPS** tab.
2. In the **Enable WPS** field, move the slider to **ON**.
3. WPS uses 2.4GHz by default. If you want to change the frequency to 5GHz, turn **OFF** the WPS function, click **Switch Frequency** in the **Current Frequency** field, and turn WPS **ON** again.

NOTE: WPS supports authentication using Open System, WPA-Personal, and WPA2-Personal. WPS does not support a wireless network that uses a Shared Key, WPA-Enterprise, and WPA2-Enterprise encryption method.

4. In the WPS Method field, select **PBC** or **PIN Code**. If you select **PBC**, go to step 5. If you select **PIN Code**, go to step 6.
5. To set up WPS using the router's WPS button, follow these steps:
 - a. Click **Start WPS** or press the WPS button found at the rear of the xDSL modem router.
 - b. Press the WPS button on your wireless device. This is normally identified by the WPS logo.

NOTE: Check your wireless device or its user manual for the location of the WPS button.

- c. The xDSL modem router will scan for any available WPS devices. If the xDSL modem router does not find any WPS devices, it will switch to standby mode.
6. To set up WPS using the Client's PIN code, follow these steps:
 - a. Locate the WPS PIN code on your wireless device's user manual or on the device itself.
 - b. Key in the Client PIN code on the text box.
 - c. Click **Start WPS** to put your xDSL modem router into WPS survey mode. The router's LED indicators quickly flash three times until the WPS setup is completed.

4.1.3 Bridge

Bridge or WDS (Wireless Distribution System) allows your ASUS Wireless xDSL Modem Router to connect to another wireless access point exclusively, preventing other wireless devices or stations to access your ASUS xDSL modem router. It can also be considered as a wireless repeater where your ASUS Wireless xDSL Modem Router communicates with another access point and other wireless devices.



To set up the wireless bridge:

1. From the navigation panel, go to **Advanced Settings > Wireless > WDS** tab.
2. In the **AP Mode** field, select any of these options:
 - **AP Only:** Disables the Wireless Bridge function.
 - **WDS Only:** Enables the Wireless Bridge feature but prevents other wireless devices/stations from connecting to the router.

- **Hybrid:** Enables the Wireless Bridge feature and allows other wireless devices/stations to connect to the router.

NOTE: In Hybrid mode, wireless devices connected to the ASUS Wireless xDSL Modem Router will only receive half the connection speed of the Access Point.

3. In the **Connect to APs in list** field, select **Yes** if you want to connect to an Access Point listed in the Remote AP List.
4. On the Remote AP List, key in a MAC address and click the **Add** button  to enter the MAC address of other available Access Points.

NOTE: Any Access Point added to the list should be on the same Control Channel as the ASUS xDSL modem router.

5. Click **Apply**.

4.1.4 Wireless MAC Filter

Wireless MAC filter provides control over packets transmitted to a specified MAC (Media Access Control) address on your wireless network.

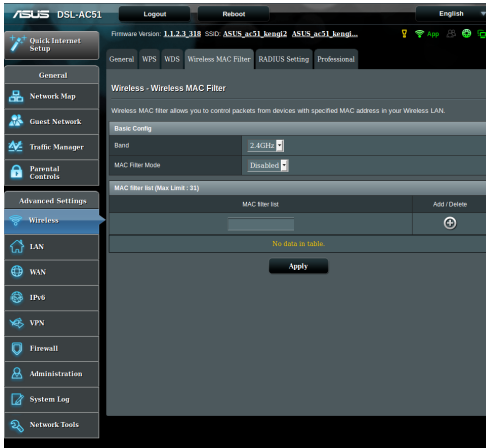

To set up the Wireless MAC filter:

1. From the navigation panel, go to **Advanced Settings > Wireless > Wireless MAC Filter** tab.
2. Enable the **Mac Filter Mode**, then in the **MAC Filter Mode** dropdown list, select either **Accept** or **Reject**.
 - Select **Accept** to allow devices in the MAC filter list to access to the wireless network.
 - Select **Reject** to prevent devices in the MAC filter list to access to the wireless network.
3. On the MAC filter list, click the **Add**  button and key in the MAC address of the wireless device.
4. Click **Apply**.

4.1.5 RADIUS Setting

RADIUS (Remote Authentication Dial In User Service) Setting provides an extra layer of security when you choose WPA-Enterprise, WPA2-Enterprise, or Radius with 802.1x as your Authentication Mode.

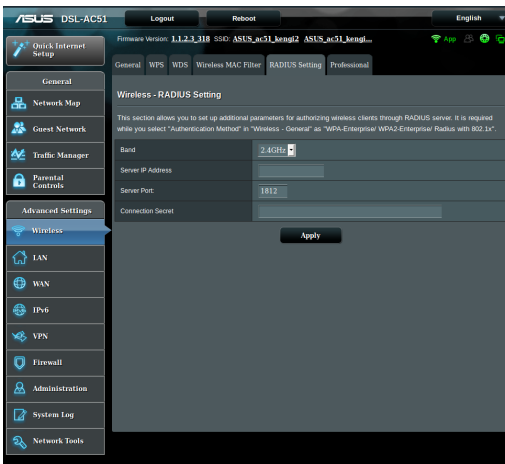

To set up wireless RADIUS settings:

1. Ensure that the xDSL modem router's authentication mode is set to WPA-Enterprise, WPA2-Enterprise, or Radius with 802.1x.

NOTE: Please refer to section **4.1.1 General** for configuring your xDSL modem router's Authentication Mode.

2. From the navigation panel, go to **Advanced Settings > Wireless > RADIUS Setting**.
3. Select the frequency band.
4. In the **Server IP Address** field, key in your RADIUS server's IP Address.
5. In the **Connection Secret** field, assign the password to access your RADIUS server.
6. Click **Apply**.

4.1.6 Professional

The Professional screen provides advanced configuration options.

NOTE: We recommend that you use the default values on this page.

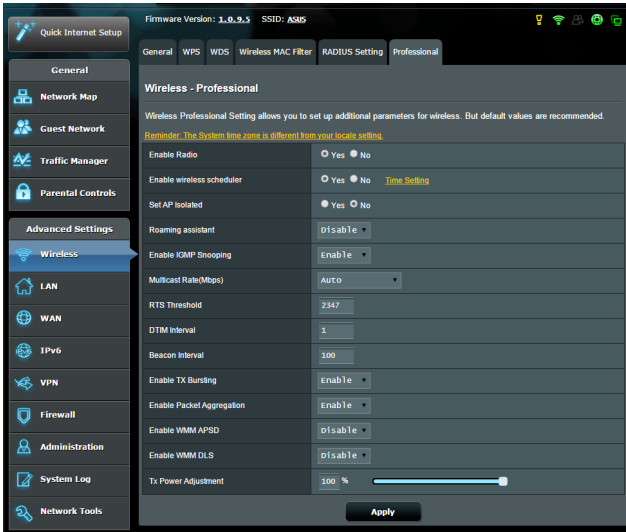

In the **Professional Settings** screen, you can configure the following:

- **Band:** Select the frequency band that the professional settings will be applied to.
- **Enable Radio:** Select **Yes** to enable wireless networking. Select **No** to disable wireless networking.
- **Enable Wireless Scheduler:** You can set the time range when wireless networking is enabled during the week.
- **Date to Enable Radio:** You can specify which days of the week wireless networking is enabled.
- **Time of Day to Enable Radio:** You can specify a time range when wireless networking is enabled during the week.

- **Set AP isolated:** The Set AP isolated item prevents wireless devices on your network from communicating with each other. This feature is useful if many guests frequently join or leave your network. Select **Yes** to enable this feature or select **No** to disable.
- **Roaming Assistant:** In network configurations that involve multiple Access, Points or wireless repeater, wireless clients sometimes cannot connect automatically to the best available AP because they are still connected to the main wireless router. Enable this setting so that the client will disconnect from the main wireless router if the signal strength is under a specific threshold and connect to a stronger signal.
- **Enable IGMP Snooping:** Select **Enable** as the default value to help improve the speed of transmission.
- **Multicast rate (Mbps):** Select the multicast transmission rate or click **Disable** to switch off simultaneous single transmission.
- **RTS Threshold:** Select a lower value for RTS (Request to Send) Threshold to improve wireless communication in a busy or noisy wireless network with high network traffic and numerous wireless devices.
- **DTIM Interval:** DTIM (Delivery Traffic Indication Message) Interval or Data Beacon Rate is the time interval before a signal is sent to a wireless device in sleep mode indicating that a data packet is awaiting delivery. The default value is three milliseconds.
- **Beacon Interval:** Beacon Interval is the time between one DTIM and the next. The default value is 100 milliseconds. Lower the Beacon Interval value for an unstable wireless connection or for roaming devices.
- **Enable TX Bursting:** Enable TX Bursting improves transmission speed between the xDSL modem router and 802.11g devices.
- **Enable Packet Aggregation:** The default value is enabling the process of joining multiple packets together into a single transmission unit.

- **Enable WMM APSD:** Enable WMM APSD (Wi-Fi Multimedia Automatic Power Save Delivery) to improve power management between wireless devices. Select **Disable** to switch off WMM APSD.
- **Enable WMM DLS:** Select **Enable** to set WMM Direct Link Setup.
- **TX Power adjustment:** TX Power adjustment refers to the milliWatts (mW) needed to power the radio signal output of the xDSL modem router. Enter a value between 0 to 100.

NOTE: Increasing the TX Power adjustment values may affect the stability of the wireless network.

4.2 LAN

4.2.1 LAN IP

The LAN IP screen allows you to modify the LAN IP settings of your xDSL modem router.

NOTE: Any changes to the LAN IP address will be reflected on your DHCP settings.

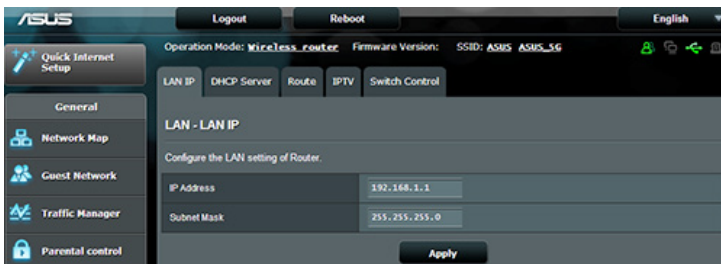

To modify the LAN IP settings:

1. From the navigation panel, go to **Advanced Settings > LAN > LAN IP** tab.
2. Modify the **IP address** and **Subnet Mask**.
3. When done, click **Apply**.

4.2.2 DHCP Server

Your xDSL modem router uses DHCP to assign IP addresses automatically on your network. You can specify the IP address range and lease time for the clients on your network.

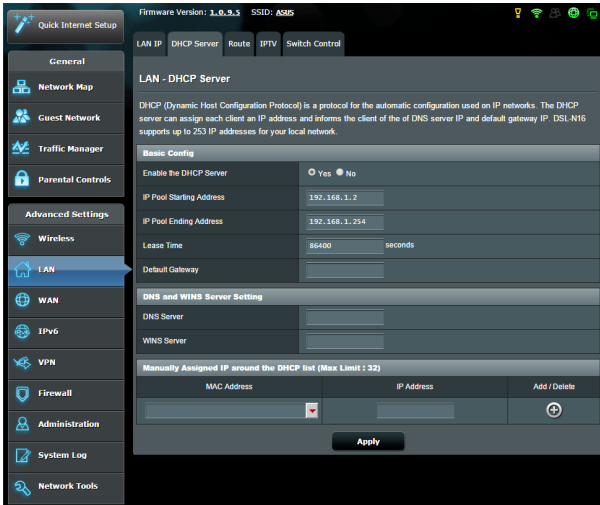

To configure the DHCP server:

1. From the navigation panel, go to **Advanced Settings > LAN > DHCP Server** tab.
2. In the **Enable the DHCP Server** field, tick **Yes**.
3. In the **IP Pool Starting Address** field, key in the starting IP address.
4. In the **IP Pool Ending Address** field, key in the ending IP address.
5. In the **Lease Time** field, specify in seconds when an assigned IP address will expire. Once it reaches this time limit, the DHCP server will then assign a new IP address.

NOTES:

- We recommend that you use an IP address format of 192.168.1.xxx (where xxx can be any number between 2 and 254) when specifying an IP address range.
 - An IP Pool Starting Address should not be greater than the IP Pool Ending Address.
-
6. In the **DNS and WINS Server Settings** section, key in your DNS Server and WINS Server IP address if needed.
 7. Your xDSL modem router can also manually assign IP addresses to devices on the network. Up to 32 MAC Addresses can be added to the DHCP list for manual assignment.



4.2.3 Route

If your network makes use of more than one xDSL modem router, you can configure a routing table to share the same Internet service.

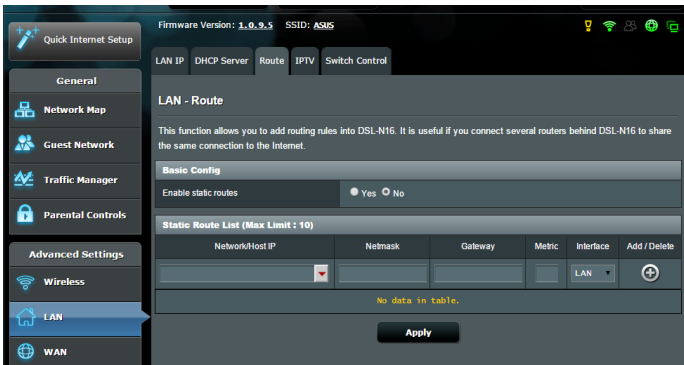
NOTE: We recommend that you do not change the default route settings unless you have advanced knowledge of routing tables.



To configure the LAN Routing table:

1. From the navigation panel, go to **Advanced Settings** > **LAN** > **Route** tab.
2. On the **Enable static routes** field, choose **Yes**.
3. On the **Static Route List**, enter the network information of other access points or nodes. Click the **Add**  or **Delete**  button to add or remove a device on the list.
4. Click **Apply**.

4.2.4 IPTV

The xDSL modem router supports connection to IPTV services through an ISP or a LAN. The IPTV tab provides the configuration settings needed to set up IPTV, VoIP, multicasting, and UDP for your service. Contact your ISP for specific information regarding your service.

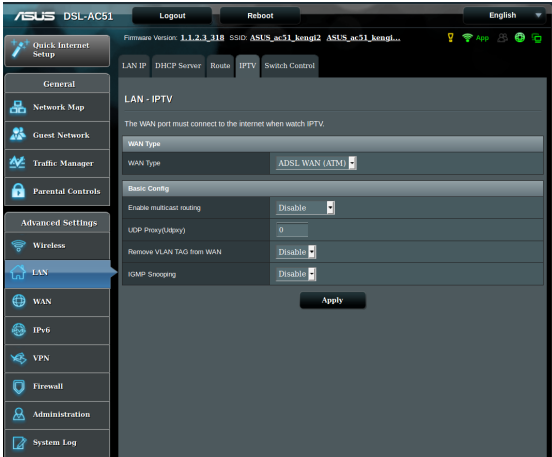

4.3 WAN

4.3.1 Internet Connection

The Internet Connection screen allows you to configure the settings of various WAN connection types.

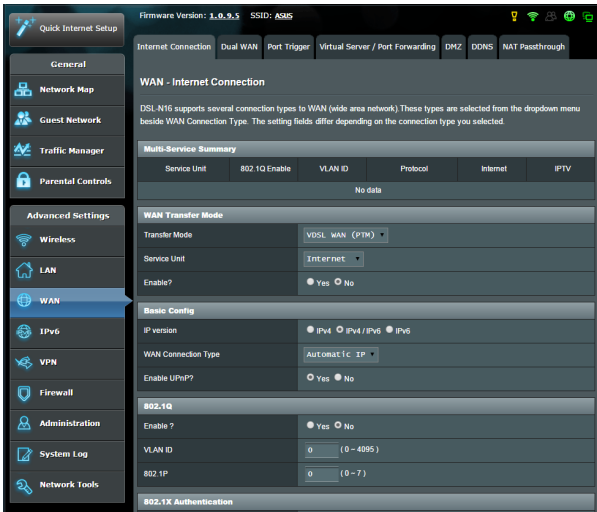

To configure the WAN connection settings:

1. From the navigation panel, go to **Advanced Settings > WAN > Internet Connection** tab.
2. Configure the following settings below. When done, click **Save**.
 - **WAN Transfer Mode**
 - Choose your Internet Service Provider type. The choices are **VDSL WAN (PTM)**, **ADSL WAN (ATM)**, **Ethernet WAN**. Consult your ISP if the router is unable to obtain a valid IP address or if you are unsure the WAN connection type.
 - **Service Unit**: To set the value of transmission via Internet or bridge.

- **Enable:** Select **Yes** to enable the Internet access. Select **No** to disable the Internet access.
- **Basic Config**
 - **IP version:** Select your IP version type. The choices are **IPv4**, **IPv4/IPv6**, and **IPv6**.
 - **WAN Connection Type:** Select the correct connection type based on your ISP service type. The choices are **Automatic IP**, **Static IP**, and **PPPoE**.
 - **Enable UPnP:** UPnP (Universal Plug and Play) allows several devices (such as routers, televisions, stereo systems, game consoles, and cellular phone) to be controlled via an IP-based network with or without a central control through a gateway. UPnP connects PCs of all form factors, providing a seamless network for remote configuration and data transfer. Using UPnP, a new network device is discovered automatically. Once connected to the network, devices can be remotely configured to support P2P applications, interactive gaming, video conferencing, and web or proxy servers. Unlike Port forwarding, which involves manually configuring port settings, UPnP automatically configures the router to accept incoming connections and direct requests to a specific PC on the local network.
- **IPv4 Setting**
 - **Connect to DNS Server automatically:** Allows this router to get the DNS IP address from the ISP automatically. A DNS is a host on the Internet that translates Internet names to numeric IP addresses.
 - **Enable NAT:** NAT (Network Address Translation) is a system where one public IP (WAN IP) is used to provide Internet access to network clients with a private IP address in a LAN. The private IP address of each network client is saved in a NAT table and is used to route incoming data packets.

• Special Requirement from ISP

- **Host Name:** This field allows you to provide a host name for your router. It is usually a special requirement from your ISP. If your ISP assigned a host name to your computer, enter the host name here.
- **MAC Address:** MAC (Media Access Control) address is a unique identifier for your networking device. Some ISPs monitor the MAC address of networking devices that connect to their service and reject any unrecognized device that attempt to connect. To avoid connection issues due to an unregistered MAC address, you can:
 - Contact your ISP and update the MAC address associated with your ISP service.
 - Clone or change the MAC address of the ASUS wireless router to match the MAC address of the previous networking device recognized by the ISP.

4.3.2 Dual WAN

DSL-AC51 provides Dual WAN support. Select **Failover mode** to turn a LAN port to a WAN port for backup network access.

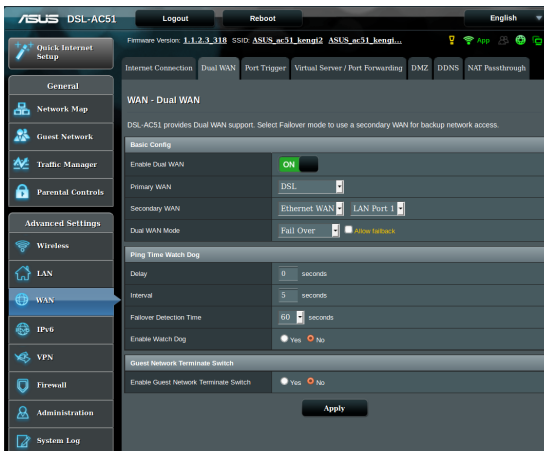

4.3.3 Port Trigger

Port range triggering opens a predetermined incoming port for a limited period of time whenever a client on the local area network makes an outgoing connection to a specified port. Port triggering is used in the following scenarios:

- More than one local client needs port forwarding for the same application at a different time.
- An application requires specific incoming ports that are different from the outgoing ports.

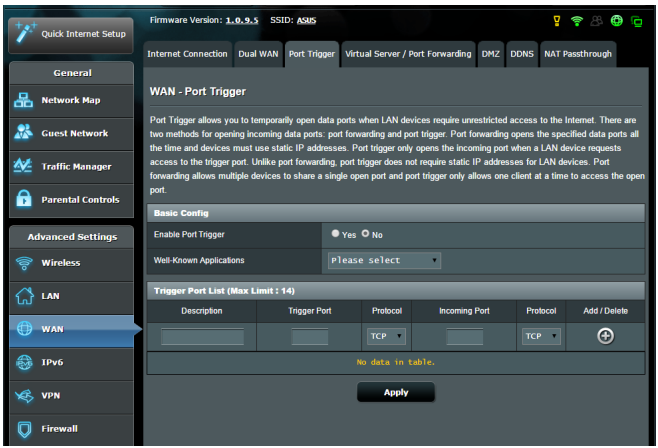

To set up Port Trigger:

1. From the navigation panel, go to **Advanced Settings > WAN > Port Trigger** tab.
2. Configure the following settings below. When done, click **Apply**.
 - **Enable Port Trigger:** Choose **Yes** to enable Port Trigger.
 - **Well-Known Applications:** Select popular games and web services to add to the Port Trigger List.
 - **Description:** Enter a short name or description for the service.

- **Trigger Port:** Specify a trigger port to open the incoming port.
- **Protocol:** Select the protocol, TCP, or UDP.
- **Incoming Port:** Specify an incoming port to receive inbound data from the Internet.
- **Protocol:** Select the protocol, TCP, or UDP.

NOTES:

- When connecting to an IRC server, a client PC makes an outgoing connection using the trigger port range 66660-7000. The IRC server responds by verifying the username and creating a new connection to the client PC using an incoming port.
 - If Port Trigger is disabled, the router drops the connection because it is unable to determine which PC is requesting for IRC access. When Port Trigger is enabled, the router assigns an incoming port to receive the inbound data. This incoming port closes once a specific time period has elapsed because the router is unsure when the application has been terminated.
 - Port triggering only allows one client in the network to use a particular service and a specific incoming port at the same time.
 - You cannot use the same application to trigger a port in more than one PC at the same time. The router will only forward the port back to the last computer to send the router a request/trigger.
-

4.3.4 Virtual Server/Port Forwarding

Port forwarding is a method to direct network traffic from the Internet to a specific port or a specific range of ports to a device or number of devices on your local network. Setting up Port Forwarding on your router allows PCs outside the network to access specific services provided by a PC in your network.

NOTE: When port forwarding is enabled, the ASUS router blocks unsolicited inbound traffic from the Internet and only allows replies from outbound requests from the LAN. The network client does not have access to the Internet directly, and vice versa.

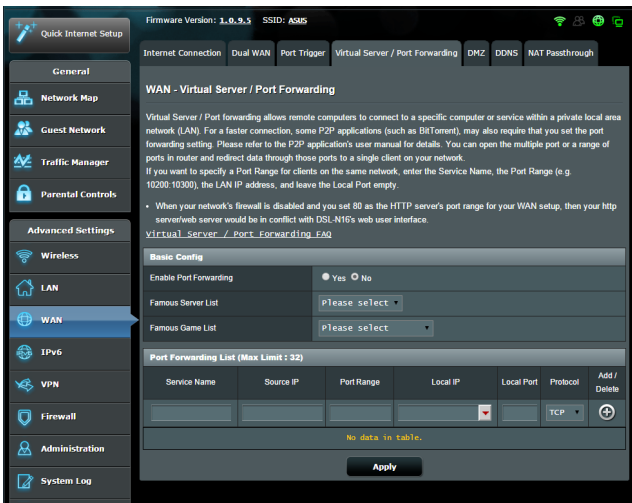

To set up Port Forwarding:

1. From the navigation panel, go to **Advanced Settings > WAN > Virtual Server / Port Forwarding** tab.

2. Configure the following settings below. When done, click **Apply**.
 - **Enable Port Forwarding:** Choose **Yes** to enable Port Forwarding.
 - **Famous Server List:** Determine which type of service you want to access.
 - **Famous Game List:** This item lists ports required for popular online games to work correctly.
 - **FTP Server Port:** Avoid assigning the port range 20:21 for your FTP server as this would conflict with the router's native FTP server assignment.
 - **Service Name:** Enter a service name.
 - **Port Range:** If you want to specify a Port Range for clients on the same network, enter the Service Name, the Port Range (e.g. 10200:10300), the LAN IP address, and leave the Local Port empty. Port range accepts various formats such as Port Range (300:350), individual ports (566,789) or Mix (1015:1024,3021).

NOTES:

- When your network's firewall is disabled and you set 80 as the HTTP server's port range for your WAN setup, then your http server/web server would be in conflict with the router's web user interface.
 - A network makes use of ports in order to exchange data, with each port assigned a port number and a specific task. For example, port 80 is used for HTTP. A specific port can only be used by one application or service at a time. Hence, two PCs attempting to access data through the same port at the same time would fail. For example, you cannot set up Port Forwarding for port 100 for two PCs at the same time.
-

- **Local IP:** Key in the client's LAN IP address.

NOTE: Use a static IP address for the local client to make port forwarding work properly. Refer to section **4.2 LAN** for information.

- **Local Port:** Enter a specific port to receive forwarded packets. Leave this field blank if you want the incoming packets to be redirected to the specified port range.
- **Protocol:** Select the protocol. If you are unsure, select **BOTH**.

To check if Port Forwarding has been configured successfully:

- Ensure that your server or application is set up and running.
- You will need a client outside your LAN but has Internet access (referred to as "Internet client"). This client should not be connected to the ASUS router.
- On the Internet client, use the router's WAN IP to access the server. If port forwarding has been successful, you should be able to access the files or applications.

Differences between port trigger and port forwarding:

- Port triggering will work even without setting up a specific LAN IP address. Unlike port forwarding, which requires a static LAN IP address, port triggering allows dynamic port forwarding using the router. Predetermined port ranges are configured to accept incoming connections for a limited period of time. Port triggering allows multiple computers to run applications that would normally require manually forwarding the same ports to each PC on the network.
- Port triggering is more secure than port forwarding since the incoming ports are not open all the time. They are opened only when an application is making an outgoing connection through the trigger port.

4.3.5 DMZ

Virtual DMZ exposes one client to the Internet, allowing this client to receive all inbound packets directed to your Local Area Network.

Inbound traffic from the Internet is usually discarded and routed to a specific client only if port forwarding or a port trigger has been configured on the network. In a DMZ configuration, one network client receives all inbound packets.

Setting up DMZ on a network is useful when you need incoming ports open or you want to host a domain, web, or e-mail server.

Caution: Opening all the ports on a client to the Internet makes the network vulnerable to outside attacks. Please be aware of the security risks involved in using DMZ.

To set up DMZ:

1. From the navigation panel, go to **Advanced Settings > WAN > DMZ** tab.
2. Configure the setting below. When done, click **Apply**.
 - **IP address of Exposed Station:** Key in the client's LAN IP address that will provide the DMZ service and be exposed on the Internet. Ensure that the server client has a static IP address.

To remove DMZ:

1. Delete the client's LAN IP address from the **IP Address of Exposed Station** text box.
2. When done, click **Apply**.

4.3.6 DDNS

Setting up DDNS (Dynamic DNS) allows you to access the router from outside your network through the provided ASUS DDNS Service or another DDNS service.

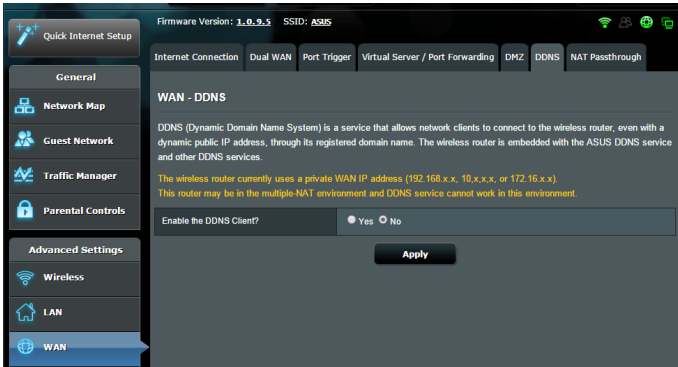

To set up DDNS:

1. From the navigation panel, go to **Advanced Settings > WAN > DDNS** tab.
2. Configure the following settings below. When done, click **Apply**.
 - **Enable the DDNS Client:** Enable DDNS to access the ASUS router via the DNS name rather than WAN IP address.
 - **Server and Host Name:** Choose ASUS DDNS or other DDNS. If you want to use ASUS DDNS, fill in the Host Name in the format of xxx.asuscomm.com (xxx is your host name).
 - If you want to use a different DDNS service, click FREE TRIAL and register online first. Fill in the User Name or E-mail Address and Password or DDNS Key fields.

NOTES:

DDNS service will not work under these conditions:

- When the xDSL modem router is using a private WAN IP address (192.168.x.x, 10.x.x.x, or 172.16.x.x), as indicated by a yellow text.
 - The router may be on a network that uses multiple NAT tables.
-

4.3.7 NAT Passthrough

NAT Passthrough allows a Virtual Private Network (VPN) connection to pass through the router to the network clients.

PPTP Passthrough, L2TP Passthrough, IPsec Passthrough, RTSP Passthrough, H.323 Passthrough, and SIP Passthrough are enabled by default.

To enable / disable the NAT Passthrough settings, go to the **Advanced Settings > WAN > NAT Passthrough** tab. When done, click **Apply**.

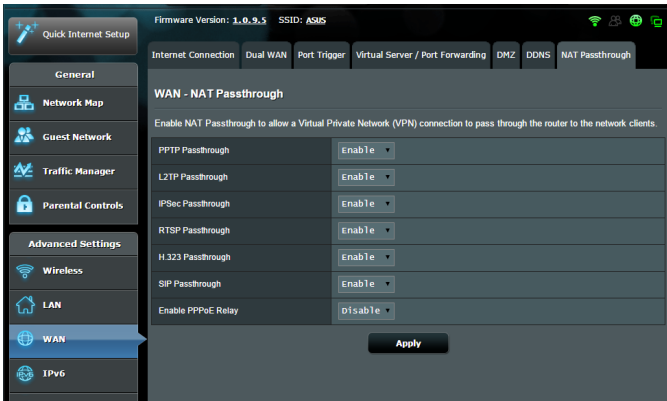

4.4 IPV6

This xDSL modem router supports IPv6 addressing, a system that supports more IP addresses. This standard is not yet widely available. Contact your ISP if your Internet service supports IPv6.

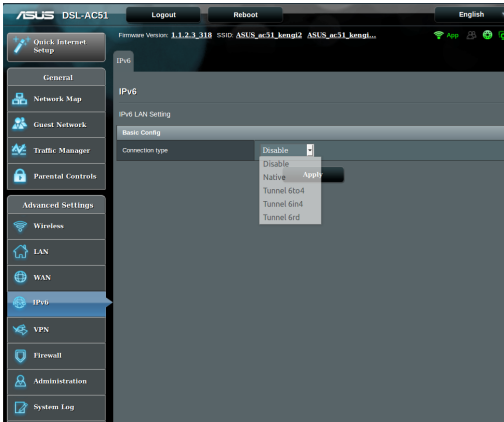

To set up IPv6:

1. From the navigation panel, go to **Advanced Settings > IPv6**.
2. Select your **Connection Type**. The configuration options vary depending on your selected connection type.
3. Enter your IPv6 LAN and DNS settings.
4. Click **Apply**.

NOTE: Please refer to your ISP regarding specific IPv6 information for your Internet service.

4.5 VPN Server

VPN (Virtual Private Network) provides a secure communication to a remote computer or remote network using a public network such as the Internet.

NOTE: Before setting up a VPN connection, you would need the IP address or domain name of the VPN server you are trying to access.

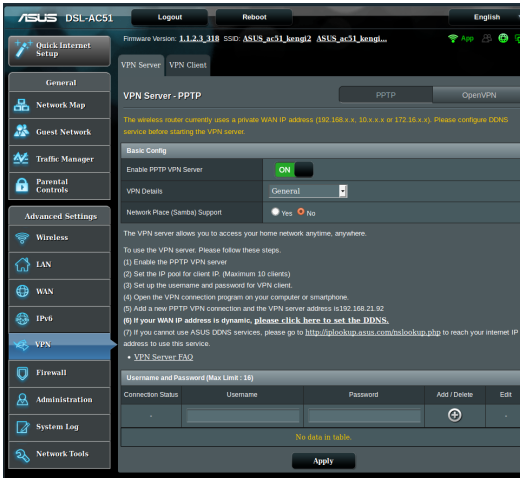

To set up access to a VPN server:

1. From the navigation panel, go to **Advanced Settings > VPN Server**.
2. On the **Enable PPTP VPN Server** field, select **ON**.
3. On the **VPN Details** dropdown list, select **Advanced Settings** if want to configure advanced VPN settings such as broadcast support, authentication, MPPE Encryption, and Client IP address range.
4. On the **Network Place (Samba) Support** field, select **Yes**.
5. Enter the user name and password for accessing the VPN server. Click the  button.
6. Click **Apply**.

4.6 Firewall

The xDSL modem router can serve as a hardware firewall for your network.

NOTE: The Firewall feature is enabled by default.

4.6.1 General

To set up basic Firewall settings:

1. From the navigation panel, go to **Advanced Settings > Firewall > General** tab.
2. On the **Enable Firewall** field, select **Yes**.
3. On the **Enable DoS protection**, select **Yes** to protect your network from DoS (Denial of Service) attacks though this may affect your router's performance.
4. You can also monitor packets exchanged between the LAN and WAN connection. On the Logged packets type, select **Dropped, Accepted, or Both**.
5. Click **Apply**.

4.6.2 URL Filter

You can specify keywords or web addresses to prevent access to specific URLs.

NOTE: The URL Filter is based on a DNS query. If a network client has already accessed a website such as <http://www.abcxxx.com>, then the website will not be blocked (a DNS cache in the system stores previously visited websites). To resolve this issue, clear the DNS cache before setting up the URL Filter.

To set up a URL filter:

1. From the navigation panel, go to **Advanced Settings > Firewall > URL Filter** tab.
2. On the Enable URL Filter field, select **Enabled**.
3. Enter a URL and click the  button.
4. Click **Apply**.

4.6.3 Keyword Filter

Keyword filter blocks access to webpages containing specified keywords.

To set up a keyword filter:

1. From the navigation panel, go to **Advanced Settings > Firewall > Keyword Filter** tab.
2. On the Enable Keyword Filter field, select **Enabled**.
3. Enter a word or phrase and click the  button.
4. Click **Apply**.

NOTES:

- The Keyword Filter is based on a DNS query. If a network client has already accessed a website such as `http://www.abcxxx.com`, then the website will not be blocked (a DNS cache in the system stores previously visited websites). To resolve this issue, clear the DNS cache before setting up the Keyword Filter.
 - Web pages compressed using HTTP compression cannot be filtered. HTTPS pages also cannot be blocked using a keyword filter.
-

4.6.4 Network Services Filter

The Network Services Filter blocks LAN to WAN packet exchanges and restricts network clients from accessing specific web services such as Telnet or FTP.

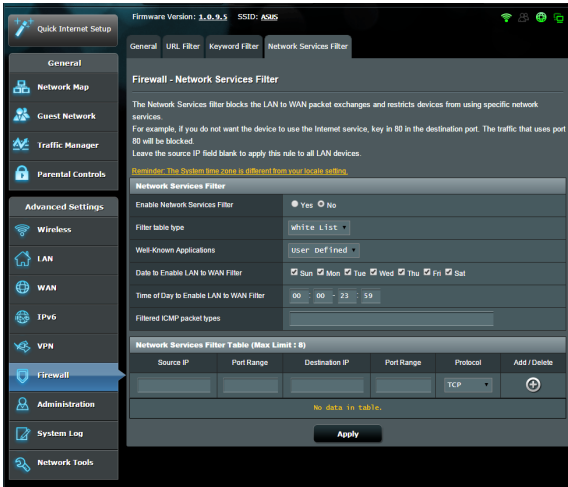

To set up a Network Service filter:

1. From the navigation panel, go to **Advanced Settings > Firewall > Network Service Filter** tab.
2. On the Enable Network Services Filter field, select **Yes**.
3. Select the Filter table type. **Black List** blocks the specified network services. **White List** limits access to only the specified network services.
4. Specify the day and time when the filters will be active.
5. To specify a Network Service to filter, enter the Source IP, Destination IP, Port Range, and Protocol. Click the  button.
6. Click **Apply**.

4.7 Administration

4.7.1 System

The **System** page allows you to configure your xDSL modem router settings. To set up the System settings:

1. From the navigation panel, go to **Advanced Settings > Administration > System** tab.
2. You can configure the following settings:
 - **Change router login password:** You can change the password and login name for the xDSL modem router by entering a new name and password.
 - **WPS button behavior:** The physical WPS button on the xDSL modem router can be used to activate WPS.
 - **Time Zone:** Select the time zone for your network.
 - **NTP Server:** The xDSL modem router can access a NTP (Network time Protocol) server in order to synchronize the time.
 - **Enable Telnet:** Click **Yes** to enable Telnet services on the network. Click **No** to disable Telnet.
 - **Authentication Method:** You can select HTTP, HTTPS, or both protocols to secure router access.
 - **Enable Web Access from WAN:** Select **Yes** to allow devices outside the network to access the xDSL modem router GUI settings. Select **No** to prevent access.
3. Click **Apply**.

4.7.2 Firmware Upgrade

NOTE: Download the latest firmware from the ASUS website at <http://www.asus.com>

To upgrade the firmware:

1. From the navigation panel, go to **Advanced Settings > Administration > Firmware Upgrade** tab.
2. In the **New Firmware File** field, click **Browse** to locate the downloaded file.
3. Click **Upload**.

NOTES:

- When the upgrade process is complete, wait for some time for the system to reboot.
 - If the upgrade process fails, the xDSL modem router automatically enters rescue mode and the power LED indicator on the front panel starts flashing slowly. To recover or restore the system, refer to section **5.2 Firmware Restoration**.
-

4.7.3 Restore/Save/Upload Setting

To restore/save/upload xDSL modem router settings:

1. From the navigation panel, go to **Advanced Settings > Administration > Restore/Save/Upload Setting** tab.
2. Select the tasks that you want to do:
 - To restore to the default factory settings, click **Restore**, and click **OK** in the confirmation message.
 - To save the current system settings, click **Save**, navigate to the folder where you intend to save the file and click **Save**.

- To restore from a saved system settings file, click **Browse** to locate your file, then click **Upload**.

NOTE: If issues occur, upload the latest firmware version and configure new settings. Do not restore the router to its default settings.

4.7.4 DSL Setting

This page allows you to configure your DSL settings.

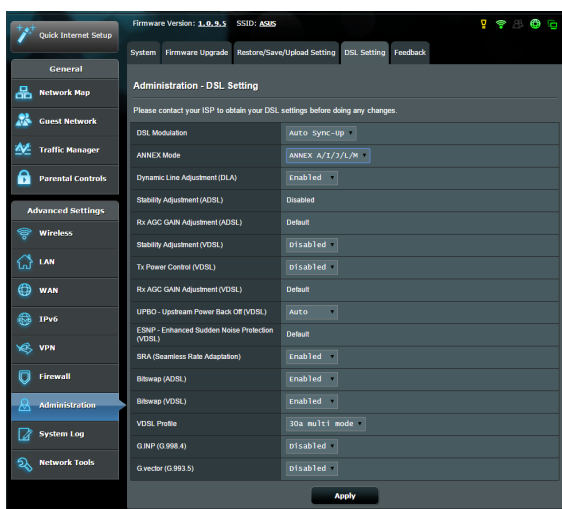

IMPORTANT! Please contact your ISP to obtain your DSL settings before doing any changes.

You can configure the following settings:

- **DSL Modulation:** This device supports VDSL2, ADSL2+, ADSL2, G.DMT, T.1413 and G.lite. The system Auto Sync-Up by default.
- **Annex Mode:** This device supports different DSL Variant (Annex) – Annex A, Annex I, Annex A/L, Annex M, A/J/J/L/M (multiple-mode), Annex B, Annex B/J (multiple-mode). Contact your ISP to find out the DSL variant (annex) that is used on your DSL line.

- **Dynamic Line Adjustment (ADSL):** This function allows the system to monitor and maintain the stability of the ADSL line. This function is enabled by default, and the system adopts corresponding changes based on the current ADSL line condition.
- **Stability Adjustment (ADSL):** It allows you to configure the Signal-to-Noise Ratio Offset. Set the value for this item based on the following conditions:
 - **Normal DSL connection:** Set the value from 1 dB ~ 10dB for maximum performance.
 - **Unstable or no ADSL connection:** Set the value to a negative dB such as -1 dB.
 - **Persistent issue with unstable or no ADSL connection:** Set the value from -2dB ~ -10 dB for maximum stability.
- **Rx AGC GAIN Adjustment (ADSL):** Allows you to configure Rx AGC GAIN (Auto Gain Control) for your ADSL line. You can set this item to any of these modes:
 - **Stable:** Select this mode to get a stable ADSL connection.
 - **High Performance:** Select this mode to improve the current downstream speed.
 - **Default:** Select this mode for your xDSL modem router to automatically assign the suitable mode for your ADSL line.
- **Stability Adjustment (VDSL):** It allows you to configure the target SNRM (Signal-to-Noise Ratio Margin) for your VDSL connection. When configuring this item, you may consider the following scenarios:
 - For maximum downstream performance, set this item to a value lower than the original (such as from 8dB to 7dB or lower).

IMPORTANT! Setting a low value may weaken your xDSL modem router defense against line noise, and may result to VDSL sync loss or failure.

- For a more stable VDSL connection, set this item to a higher value such as 9dB ~ 30dB.
- **Tx Power Control (VDSL):** It allows you to configure the Tx Power for VDSL to improve the downstream speed. A low Tx Power value increases the downstream speed but affects the upstream speed, and vice versa.

- **Rx AGC GAIN Adjustment (VDSL):** Allows you to configure Rx AGC GAIN (Auto Gain Control) for your VDSL line. You can set this item to any of these modes:
 - **Stable:** Select this mode to get a stable VDSL connection.
 - **High Performance:** Select this mode to improve the current downstream speed.
 - **Default:** Select this mode for your xDSL modem router to automatically assign the suitable mode for your VDSL line.
- **UPBO/Upstream Power Back Off (VDSL):** This item allows you to enable or disable UPBO (Upstream Power Back Off) for VDSL. DSLAM (Digital Subscriber Line Access Multiplexer) uses UPBO to reduce the Tx Power of your xDSL modem router. In some cases, UPBO control from DSLAM may lead to sync issue, such as Tx Power is too low to sync at minimum rate. Disable this item to prevent any DSLAM-related sync issues.
- **Seamless Rate Adaptation:** This item allows you to enable SRA (Seamless Rate Adaptation) for consistent data transfer rates and preventing dropped connections. You may disable this item when your connection is very stable and there is a decrease in download or upload speed.
- **Bitswap:** This item allows you to enable Bitswap, which adjusts bits allocated for bins/channels. Busy or congested bins/channels are assigned fewer bits while available channels are allocated more bits to handle.
- **VDSL Profile:** This item allows you to configure the VDSL Profile. The default value is 30a multi mode.

NOTE: For some ISPs with non-standard 30a multi mode VDSL DSLAM sync setting, such as for ISP services in Germany, set the VDSL Profile to 17a multi mode to sync up the VDSL line.

4.7.5 Feedback

DSL feedback is used to diagnose problems and help to improve the user experience of ASUS xDSL modem router. Complete the form, and it will be send to ASUS Support Team.

The screenshot shows the ASUS DSL-N16 web interface. At the top, it displays 'Firmware Version: 1.0.9.3' and 'SSID: ASUS'. Below this are navigation tabs: 'System', 'Firmware Upgrade', 'Restore/Save/Upload Setting', 'DSL Setting', and 'Feedback'. The left sidebar contains a menu with categories: 'General' (Network Map, Guest Network, Traffic Manager, Parental Controls), 'Advanced Settings' (Wireless, LAN, WAN, IPv6, VPN, Firewall), and 'Administration' (Administration, System Log, Network Tools). The 'Administration - Feedback' page is active, showing a form with the following fields: 'Your Country *', 'Your ISP / Internet Service Provider *', 'Name of the Subscribed Plan/Service/Package *', 'Your e-mail Address *', and 'Extra information for debugging *' (with checkboxes for Syslog, Getting file, and Update setting). A dropdown menu for 'Choose which option best describes the performance of your DSL service' is set to 'Please select ...'. Below this is a large text area for 'Comments / Suggestions *' with a character count of 'Maximum of 2000 characters - characters left: 2000'. A 'Send' button is located at the bottom of the form. A note at the bottom states: 'Note: • The Firmware and DSL Driver Version will be submitted in addition to any info you choose to include above. • DSL Feedback will be used to diagnose problems and help to improve the firmware of DSL-N16, any personal information you submitted, whether explicitly or incidentally will be protected in accordance with our privacy policy. • By submitting this DSL Feedback, you agree that ASUS may use feedback that you provided to improve ASUS xDSL modem router product.'

4.8 System Log

System Log contains your recorded network activities.

NOTE: System log resets when the router is rebooted or powered off.

To view your system log:

1. From the navigation panel, go to **Advanced Settings > System Log**.
2. You can view your network activities in any of these tabs:
 - General Log
 - DHCP Leases
 - Wireless Log
 - Port Forwarding
 - DSL Log

The screenshot shows the 'System Log - General Log' page in a router's web interface. The interface includes a navigation sidebar on the left with categories like 'General', 'Advanced Settings', and 'System Log'. The main content area displays system activities for 'Tue, Jul 21 03:28:57 2015'. The log shows various events such as CHAP authentication, IP address assignments, dnsmasq service startup, and kernel messages regarding NAT module status and WAN connection restoration. At the bottom of the log area, there are 'Clear', 'Save', and 'Refresh' buttons.

```
Firmware Version: 1.0.9.5 SSID: ASIS
General Log Wireless Log DHCP leases Routing Table Port Forwarding DSL Log
System Log - General Log
This page shows the detailed system's activities.
System Time
Tue, Jul 21 03:28:57 2015
Uptime
0 days 1 hours 21 minutes 38 seconds
2010-12-31 16:01:06 syslog: CHAP authentication succeeded
2010-12-31 16:01:06 syslog: peer from calling number 14:CC:20:05:72:77 authorized
2010-12-31 16:01:06 syslog: local IP address 10.10.1.199
2010-12-31 16:01:06 syslog: remote IP address 10.10.1.10
2010-12-31 16:01:06 syslog: primary DNS address 8.8.8.8
2010-12-31 16:01:06 syslog: secondary DNS address 8.8.4.4
2010-12-31 16:01:06 dnsmasq[2193]: started, version 2.52 cacheize 150
2010-12-31 16:01:06 dnsmasq[2193]: compile time options: IPv6 GNU-getopt no-RTCP no-DBus no
2010-12-31 16:01:07 dnsmasq[2193]: using nameserver 8.8.4.4#53
2010-12-31 16:01:07 dnsmasq[2193]: using nameserver 8.8.8.8#53
2010-12-31 16:01:07 dnsmasq[2193]: reading /etc/resolv.conf
2010-12-31 16:01:07 dnsmasq[2193]: ignoring nameserver 197.0.0.1 - local interface
2010-12-31 16:01:07 dnsmasq[2193]: using nameserver 8.8.4.4#53
2010-12-31 16:01:07 dnsmasq[2193]: using nameserver 8.8.8.8#53
2010-12-31 16:01:07 dnsmasq[2193]: read /etc/hosts = 4 addresses
2010-12-31 16:01:07 kernel: Link State: PVC_0 logistic interface up.
2010-12-31 16:01:08 kernel: Ralink HW NAT Module Disabled
2010-12-31 16:01:08 kernel: Ralink HW NAT Module Enabled
2010-12-31 16:01:08 kernel: IP check use Black List
2010-12-31 16:01:08 kernel: ddns_execute(), DDNS is not enable, so remove /etc/ddns.conf.
2010-12-31 16:01:08 kernel: Ralink HW NAT Module Disabled
2010-12-31 16:01:08 kernel: Ralink HW NAT Module Enabled
2010-12-31 16:01:08 kernel: IP check use Black List
2010-12-31 16:01:11 WAN Connection: WAN was restored.
2010-12-31 16:01:11 start nat rules: apply the nat_rules(/tmp/nat_rules)!
2015-07-21 03:10:35 WEB: WEB user admin's login
```

5 Utilities

NOTES:

- Install the xDSL modem router's utilities from the bundled support CD.
- If Autorun is disabled, run **setup.exe** from the root directory of the support CD.
- The utilities are not supported on MAC OS.

5.1 Device Discovery

Device Discovery is an ASUS WLAN utility that detects an ASUS Wireless xDSL Modem Router device, and allows you to configure the wireless networking settings.

To launch the Device Discovery utility:

- From your computer's desktop, click **Start > All Programs > ASUS Utility > Device Discovery**.

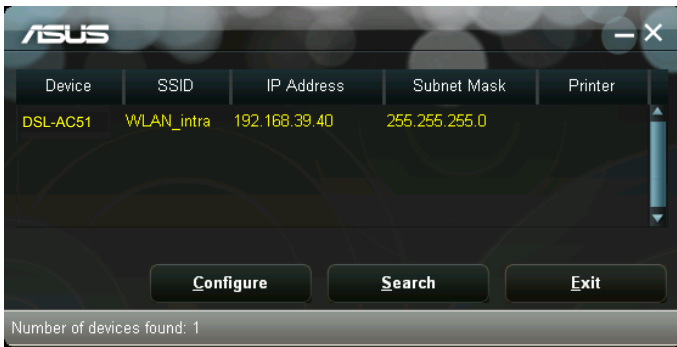

NOTE: When you set the router to Access Point mode, you need to use Device Discovery to get the router's IP address.

5.2 Firmware Restoration

Firmware Restoration is used on an ASUS Wireless xDSL Modem Router that failed during its firmware upgrading process. It uploads the firmware that you specify. The process takes about three to four minutes.

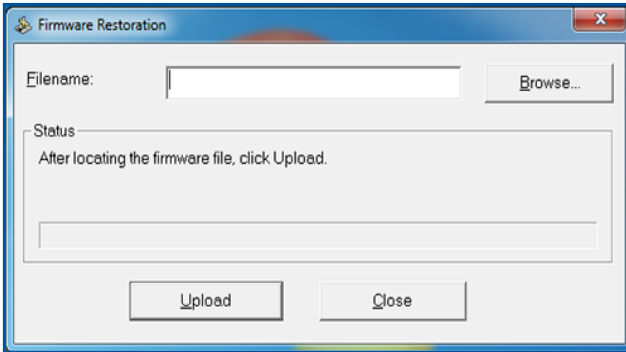

IMPORTANT: Launch the rescue mode on the router before using the Firmware Restoration utility.

NOTE: This feature is not supported on MAC OS.

To launch the rescue mode and use the Firmware Restoration utility:

1. Unplug the xDSL modem router from the power source.
2. Hold the Reset button at the rear panel and simultaneously replug the xDSL modem router into the power source. Release the Reset button when the Power LED at the front panel flashes slowly, which indicates that the xDSL modem router is in the rescue mode.

3. Set a static IP on your computer and use the following to set up your TCP/IP settings:

IP address: 192.168.1.x

Subnet mask: 255.255.255.0

4. From your computer's desktop, click **Start > All Programs > ASUS Utility DSL-AC51 xDSL modem router > Firmware Restoration.**
5. Specify a firmware file, then click **Upload.**

NOTE: This is not a firmware upgrade utility and cannot be used on a working ASUS XDSL modem router. Normal firmware upgrades must be done through the web interface. Refer to **Chapter 4: Configuring the Advanced Settings** for more details.

6 Troubleshooting

This chapter provides solutions for issues you may encounter with your router. If you encounter problems that are not mentioned in this chapter, visit the ASUS support site at: <http://support.asus.com/> for more product information and contact details of ASUS Technical Support.

6.1 Basic Troubleshooting

If you are having problems with your router, try these basic steps in this section before looking for further solutions.

Upgrade Firmware to the latest version.

1. Launch the Web GUI. Go to **Advanced Settings** > **Administration** > **Firmware Upgrade** tab. Click **Check** to verify if the latest firmware is available.

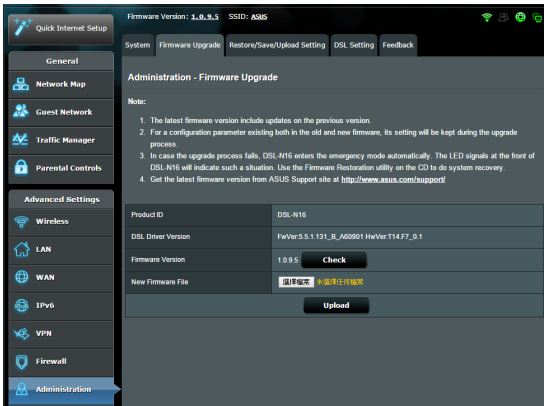

2. If the latest firmware is available, visit the ASUS global website at http://www.asus.com/Networks/Wireless_Routers/DSLAC51/#download to download the latest firmware.
3. From the **Firmware Upgrade** page, click **Browse** to locate the firmware file.
4. Click **Upload** to upgrade the firmware.

Restart your network in the following sequence:

1. Turn off the modem.
2. Unplug the modem.
3. Turn off the router and computers.
4. Plug in the modem.
5. Turn on the modem and then wait for 2 minutes.
6. Turn on the router and then wait for 2 minutes.
7. Turn on computers.

Check if your Ethernet cables are plugged properly.

- When the Ethernet cable connecting the router with the modem is plugged in properly, the WAN LED will be on.
- When the Ethernet cable connecting your powered-on computer with the router is plugged in properly, the corresponding LAN LED will be on.

Check if the wireless setting on your computer matches that of your computer.

- When you connect your computer to the router wirelessly, ensure that the SSID (wireless network name), encryption method, and password are correct.

Check if your network settings are correct.

- Each client on the network should have a valid IP address. ASUS recommends that you use the xDSL modem router's DHCP server to assign IP addresses to computers on your network.

- Some cable modem service providers require you to use the MAC address of the computer initially registered on the account. You can view the MAC address in the web GUI, **Network Map > Clients** page, and hover the mouse pointer over your device in **Client Status**.



6.2 Frequently Asked Questions (FAQs)

I cannot access the router GUI using a web browser

- If your computer is wired, check the Ethernet cable connection and LED status as described in the previous section.
- Ensure that you are using the correct login information. The default factory login name and password is “admin/admin”. Ensure that the Caps Lock key is disabled when you enter the login information.
- Delete the cookies and files in your web browser. For Internet Explorer 8, follow these steps:
 1. Launch Internet Explorer 8, then click **Tools > Internet Options**.
 2. In the **General** tab, under **Browsing history**, click **Delete...**, select **Temporary Internet Files** and **Cookies** then click **Delete**.

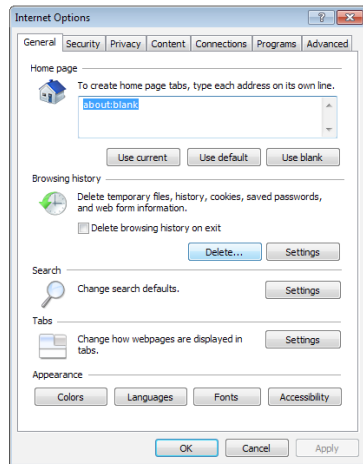

NOTES:

- The commands for deleting cookies and files vary with web browsers.
- Disable proxy server settings, cancel the dial-up connection, and set the TCP/IP settings to obtain IP addresses automatically. For more details, refer to Chapter 1 of this user manual.
- Ensure that you use CAT5e or CAT6 ethernet cables.

The client cannot establish a wireless connection with the router.

NOTE: If you are having issues connecting to 5GHz network, make sure that your wireless device supports 5GHz or features dual band capabilities.

- **Out of Range:**
 - Move the router closer to the wireless client.
 - Try to adjust antennas of the router to the best direction as described in section **1.4 Positioning your xDSL modem router.**
- **DHCP server has been disabled:**
 1. Launch the web GUI. Go to **General > Network Map > Clients** and search for the device that you want to connect to the router.
 2. If you cannot find the device in the **Network Map**, go to **Advanced Settings > LAN > DHCP Server, Basic Config** list, select **Yes** on the **Enable the DHCP Server**.

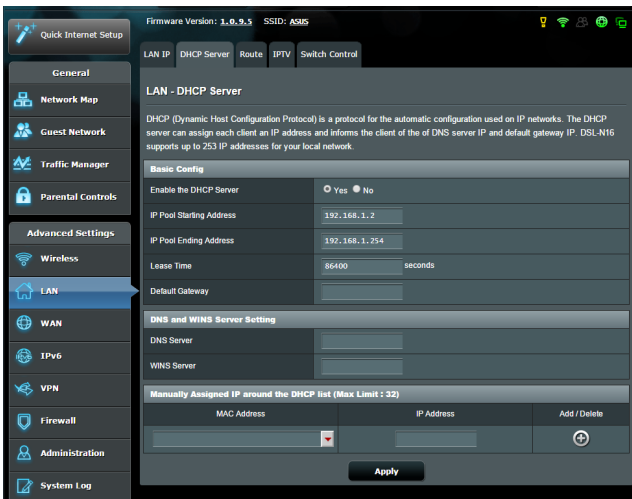

- SSID has been hidden. If your device can find SSIDs from other routers but cannot find your router's SSID, go to **Advanced Settings > Wireless > General**, select **No** on **Hide SSID**, and select **Auto** on **Control Channel**.

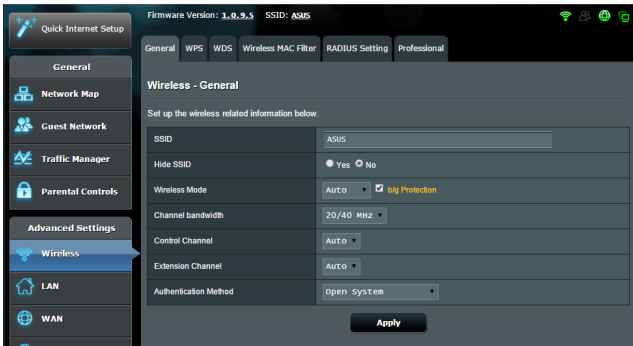

- If you are using a wireless LAN adapter, check if the wireless channel in use conforms to the channels available in your country/area. If not, adjust the channel, channel bandwidth, and wireless mode.
- If you still cannot connect to the router wirelessly, you can reset your router to factory default settings. In the router GUI, click **Administration > Restore/Save/Upload Setting** and click **Restore**.

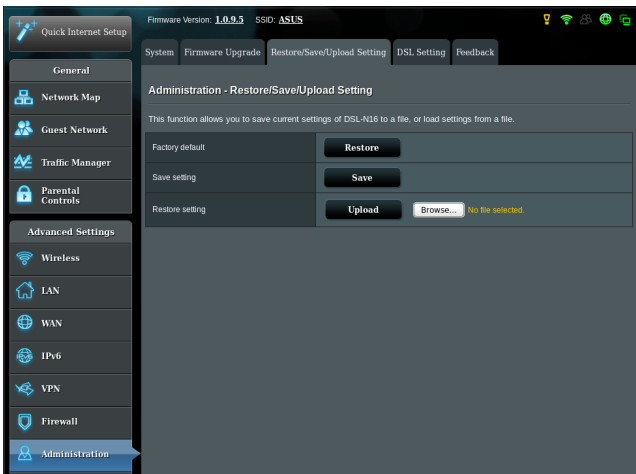

Internet is not accessible.

- Check if your router can connect to your ISP's WAN IP address. To do this, launch the web GUI and go to **General > Network Map**, and check the **Internet Status**.
- If your router cannot connect to your ISP's WAN IP address, try restarting your network as described in the section **Restart your network in following sequence** under **Basic Troubleshooting**.



- The device has been blocked via the Parental Control function. Go to **General > Parental Control** and see if the device is in the list. If the device is listed under **Client Name**, remove the device using the **Delete** button or adjust the Time Management Settings.

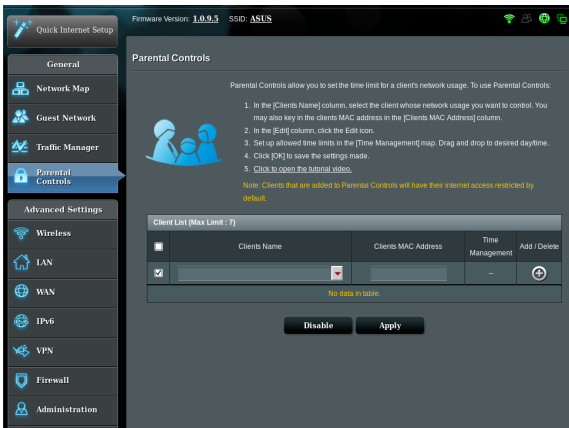

- If there is still no Internet access, try to reboot your computer and verify the network's IP address and gateway address.

- Check the status indicators on the ADSL modem and the xDSL modem router. If the WAN LED on the xDSL modem router is not ON, check if all cables are plugged properly.

You forgot the SSID (network name) or network password

- Setup a new SSID and encryption key via a wired connection (Ethernet cable). Launch the web GUI, go to **Network Map**, click the router icon, enter a new SSID and encryption key, and then click **Apply**.
- Reset your router to the default settings. Launch the web GUI, go to **Administration > Restore/Save/Upload Setting**, and click **Restore**. The default login account and password are both "admin".

How to restore the system to its default settings?

- Go to **Administration > Restore/Save/Upload Setting**, and click **Restore**.

The following are the factory default settings:

User Name:	admin
Password:	admin
Enable DHCP:	Yes (if WAN cable is plugged in)
IP address:	192.168.1.1
Domain Name:	(Blank)
Subnet Mask:	255.255.255.0
DNS Server 1:	192.168.1.1
DNS Server 2:	(Blank)
SSID (2.4GHz):	ASUS
SSID (5GHz):	ASUS_5G

Firmware upgrade failed.

Launch the rescue mode and run the Firmware Restoration utility. Refer to section **5.2 Firmware Restoration** on how to use the Firmware Restoration utility.

Cannot access Web GUI

Before configuring your xDSL modem router, do the steps described in this section for your host computer and network clients.

A. Disable the proxy server, if enabled.

Windows® 7

1. Click **Start > Internet Explorer** to launch the browser.
2. Click **Tools > Internet options > Connections tab > LAN settings**.

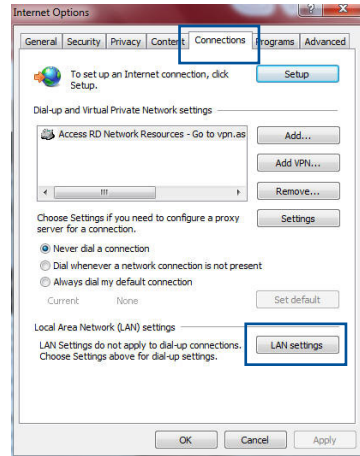

3. From the Local Area Network (LAN) Settings screen, untick **Use a proxy server for your LAN**.
4. Click **OK** when done.

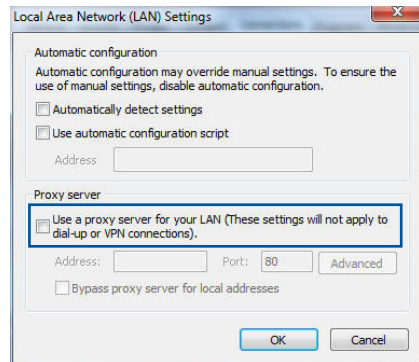

MAC OS

1. From your Safari browser, click **Safari > Preferences > Advanced > Change Settings...**
2. From the Network screen, deselect **FTP Proxy** and **Web Proxy (HTTP)**.
3. Click **Apply Now** when done.

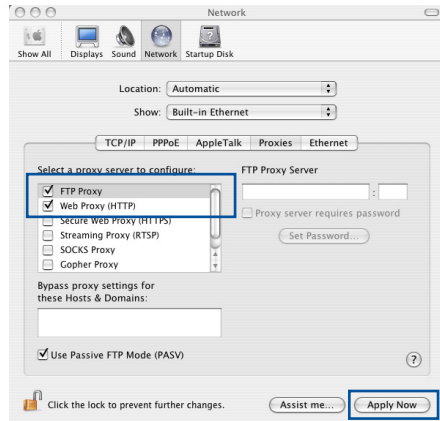

NOTE: Refer to your browser's help feature for details on disabling the proxy server.

B. Set the TCP/IP settings to automatically obtain an IP address.

Windows® 7

1. Click **Start > Control Panel > Network and Internet > Network and Sharing Center > Manage network connections.**
2. Select **Internet Protocol Version 4 (TCP/IPv4)** or **Internet Protocol Version 6 (TCP/IPv6)**, then click **Properties.**

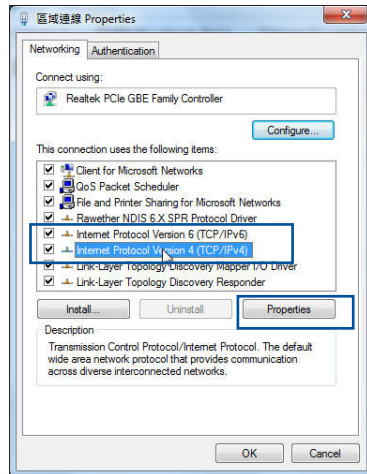

3. To obtain the IPv4 IP settings automatically, tick **Obtain an IP address automatically**.

To obtain the IPv6 IP settings automatically, tick **Obtain an IPv6 address automatically**.

4. Click **OK** when done.

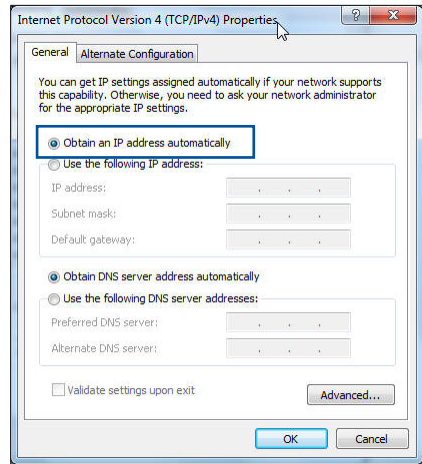

MAC OS

1. Click the Apple icon  located on the top left of your screen.
2. Click **System Preferences > Network > Configure...**
3. From the **TCP/IP** tab, select **Using DHCP** in the **Configure IPv4** dropdown list.
4. Click **Apply Now** when done.

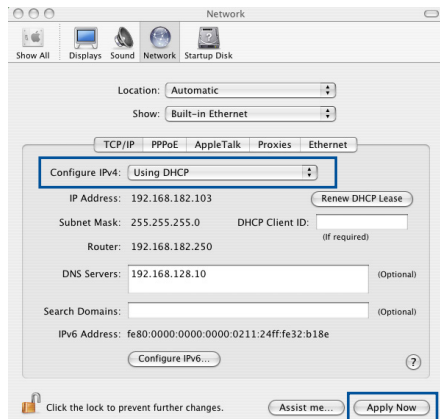

NOTE: Refer to your operating system's help and support feature for details on configuring your computer's TCP/IP settings.

C. Disable the dial-up connection, if enabled.

Windows® 7

1. Click **Start > Internet Explorer** to launch the browser.
2. Click **Tools > Internet options > Connections** tab.
3. Tick **Never dial a connection**.
4. Click **OK** when done.

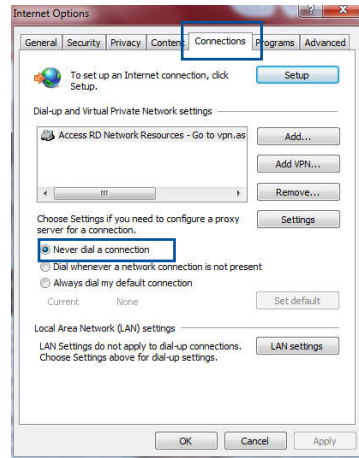

NOTE: Refer to your browser's help feature for details on disabling the dial-up connection.

Appendices

Notices

ASUS Recycling/Takeback Services

ASUS recycling and takeback programs come from our commitment to the highest standards for protecting our environment. We believe in providing solutions for you to be able to responsibly recycle our products, batteries, other components, as well as the packaging materials. Please go to <http://csr.asus.com/english/Takeback.htm> for the detailed recycling information in different regions.

REACH

Complying with the REACH (Registration, Evaluation, Authorisation, and Restriction of Chemicals) regulatory framework, we published the chemical substances in our products at ASUS REACH website at <http://csr.asus.com/english/reach.aspx>

Prohibition of Co-location

This device and its antenna(s) must not be co-located or operating in conjunction with any other antenna or transmitter.

IMPORTANT NOTE

Radiation Exposure Statement: This equipment complies with FCC radiation exposure limits set forth for an uncontrolled environment. End users must follow the specific operating instructions for satisfying RF exposure compliance. To maintain compliance with FCC exposure compliance requirement, please follow operation instruction as documented in this manual. This equipment should be installed and operated with minimum

distance 20cm between the radiator and your body.

CE statement

Simplified EU Declaration of Conformity

ASUSTek Computer Inc. hereby declares that this device is in compliance with the essential requirements and other relevant provisions of Directive 2014/53/EU. Full text of EU declaration of conformity is available at <https://www.asus.com/support/>

Declaration of Conformity for Ecodesign directive 2009/125/EC

Testing for eco-design requirements according to (EC) No 1275/2008 and (EU) No 801/2013 has been conducted. When the device is in Networked Standby Mode, its I/O and network interface are in sleep mode and may not work properly. To wake up the device, press the Wi-Fi on/off, LED on/off, reset, or WPS button.

This equipment complies with EU radiation exposure limits set forth for an uncontrolled environment. This equipment should be installed and operated with minimum distance 20 cm between the radiator & your body.

All operational modes:

2.4GHz: 802.11b, 802.11g, 802.11n (HT20), 802.11n (HT40), 5GHz: 802.11a, 802.11n (HT20), 802.11n (HT40), 802.11ac (VHT20), 802.11ac (VHT40)

The frequency, mode and the maximum transmitted power in EU are listed below:

2412-2472MHz (802.11n HT40 15 Mbps): 19.60 dBm

5180-5240MHz (802.11a 6 Mbps): 22.84 dBm

The device is restricted to indoor use only when operating in the

5150 to 5350 MHz frequency range.

	AT	BE	BG	CZ	DK	EE	FR
	DE	IS	IE	IT	EL	ES	CY
	LV	LI	LT	LU	HU	MT	NL
	NO	PL	PT	RO	SI	SK	TR
	FI	SE	CH	UK	HR		

GNU General Public License

Licensing information

This product includes copyrighted third-party software licensed under the terms of the GNU General Public License. Please see The GNU General Public License for the exact terms and conditions of this license. All future firmware updates will also be accompanied with their respective source code. Please visit our web site for updated information. Note that we do not offer direct support for the distribution.

For Turkey only

Authorised distributors in Turkey:

BOGAZICI BİL GİSAYAR SAN. VE TİC. A.S.

Tel. No.: +90 212 3311000

Address: AYAZAGA MAH. KEMERBURGAZ CAD. NO.10 AYAZAGA/
İSTANBUL

CİZGİ Elektronik San. Tic. Ltd. Sti.

Tel. No.: +90 212 3567070

Address: CEMAL SURURI CD. HALİM MERİC İS MERKEZİ
No: 15/C D:5-6 34394 MECİDİYEKOY/İSTANBUL

KOYUNCU ELEKTRONİK BİLGİ İSLEM SİST. SAN. VE DİŞ TİC. A.S.

Tel. No.: +90 216 5288888

Address: EMEK MAH.ORDU CAD. NO:18, SARİGAZİ, SANCAKTEPE
İSTANBUL

ENDEKS BİLİŞİM SAN VE DİŞ TİC LTD ŞTİ

Tel. No.: +90 216 523 35 70 (pbx)

Address: Bulgurlu Mahallesi Alemdağ Caddesi No:56 / B-1 34696
Üsküdar/ İSTANBUL

AEEE Yönetmeliğine Uygundur.

- Bu Cihaz Türkiye analog şebekelerde çalışabilecek şekilde tasarlanmıştır.
- Cihazın ayrıntılı kurulum rehberi kutu içeriğinden çıkan CD içerisindeydir. Cihazın kullanıcı arayüzü Türkçe'dir.
- Cihazın kullanılması planlanan ülkelerde herhangi bir kısıtlaması yoktur. Ülkeler simgeler halinde kutu üzerinde belirtilmiştir.

ASUS Contact information

ASUSTeK COMPUTER INC. (Asia Pacific)

Address 15 Li-Te Road, Peitou, Taipei, Taiwan 11259

Website www.asus.com.tw

Technical Support

Telephone +886228943447

Support Fax +886228907698

Online support support.asus.com

ASUS COMPUTER INTERNATIONAL (America)

Address 800 Corporate Way, Fremont, CA 94539, USA

Telephone +15107393777

Fax +15106084555

Website usa.asus.com

Online support support.asus.com

ASUS COMPUTER GmbH (Germany and Austria)

Address Harkort Str. 21-23, D-40880 Ratingen, Germany

Support Fax +49-2102-959931

Website asus.com/de

Online contact eu-rma.asus.com/sales

Technical Support

Telephone (Component) +49-2102-5789555

Telephone Germany
(System/Notebook/Eee/LCD) +49-2102-5789557

Telephone Austria
(System/Notebook/Eee/LCD) +43-820-240513

Support Fax +49-2102-959911

Online support support.asus.com

Networks Global Hotline Information

Region	Country	Hotline Number	Service Hours	
Europe	Cyprus	800-92491	09:00-13:00 ; 14:00-18:00 Mon-Fri	
	France	0033-170949400	09:00-18:00 Mon-Fri	
	Germany	0049-1805010920		
		0049-1805010923 (component support)		09:00-18:00 Mon-Fri 10:00-17:00 Mon-Fri
		0049-2102959911 (Fax)		
	Hungary	0036-15054561	09:00-17:30 Mon-Fri	
	Italy	199-400089	09:00-13:00 ; 14:00-18:00 Mon-Fri	
	Greece	00800-44142044	09:00-13:00 ; 14:00-18:00 Mon-Fri	
	Austria	0043-820240513	09:00-18:00 Mon-Fri	
	Netherlands/ Luxembourg	0031-591570290	09:00-17:00 Mon-Fri	
	Belgium	0032-78150231	09:00-17:00 Mon-Fri	
	Norway	0047-2316-2682	09:00-18:00 Mon-Fri	
	Sweden	0046-858769407	09:00-18:00 Mon-Fri	
	Finland	00358-969379690	10:00-19:00 Mon-Fri	
	Denmark	0045-38322943	09:00-18:00 Mon-Fri	
	Poland	0048-225718040	08:30-17:30 Mon-Fri	
	Spain	0034-902889688	09:00-18:00 Mon-Fri	
	Portugal	00351-707500310	09:00-18:00 Mon-Fri	
	Slovak Republic	00421-232162621	08:00-17:00 Mon-Fri	
	Czech Republic	00420-596766888	08:00-17:00 Mon-Fri	
	Switzerland-German	0041-848111010	09:00-18:00 Mon-Fri	
Switzerland-French	0041-848111014	09:00-18:00 Mon-Fri		
Switzerland-Italian	0041-848111012	09:00-18:00 Mon-Fri		
United Kingdom	0044-1442265548	09:00-17:00 Mon-Fri		
Ireland	0035-31890719918	09:00-17:00 Mon-Fri		
Russia and CIS	008-800-100-ASUS	09:00-18:00 Mon-Fri		
Ukraine	0038-0445457727	09:00-18:00 Mon-Fri		

Networks Global Hotline Information

Region	Country	Hotline Numbers	Service Hours
Asia-Pacific	Australia	1300-278788	09:00-18:00 Mon-Fri
	New Zealand	0800-278788	09:00-18:00 Mon-Fri
	Japan	0800-1232787	09:00-18:00 Mon-Fri
		0081-570783886 (Non-Toll Free)	09:00-17:00 Sat-Sun
		09:00-18:00 Mon-Fri	09:00-17:00 Sat-Sun
	Korea	0082-215666868	09:30-17:00 Mon-Fri
	Thailand	0066-24011717	09:00-18:00 Mon-Fri
		1800-8525201	
	Singapore	0065-64157917	11:00-19:00 Mon-Fri
		0065-67203835	11:00-19:00 Mon-Fri
		(Repair Status Only)	11:00-13:00 Sat
	Malaysia	1300-88-3495	9:00-18:00 Mon-Fri
	Philippine	1800-18550163	09:00-18:00 Mon-Fri
	India	1800-2090365	09:00-18:00 Mon-Sat
India(WL/NW)	09:00-21:00 Mon-Sun		
Indonesia	0062-2129495000	09:30-17:00 Mon-Fri	
	500128 (Local Only)	9:30 – 12:00 Sat	
Vietnam	1900-555581	08:00-12:00	
		13:30-17:30 Mon-Sat	
Hong Kong	00852-35824770	10:00-19:00 Mon-Sat	
Americas	USA	1-812-282-2787	8:30-12:00 EST Mon-Fri
	Canada		9:00-18:00 EST Sat-Sun
	Mexico	001-8008367847	08:00-20:00 CST Mon-Fri
			08:00-15:00 CST Sat

Networks Global Hotline Information

Region	Country	Hotline Numbers	Service Hours
Middle East + Africa	Egypt	800-2787349	09:00-18:00 Sun-Thu
	Saudi Arabia	800-1212787	09:00-18:00 Sat-Wed
	UAE	00971-42958941	09:00-18:00 Sun-Thu
	Turkey	0090-2165243000	09:00-18:00 Mon-Fri
	South Africa	0861-278772	08:00-17:00 Mon-Fri
	Israel	*6557/00972-39142800 *9770/00972-35598555	08:00-17:00 Sun-Thu 08:30-17:30 Sun-Thu
Balkan Countries	Romania	0040-213301786	09:00-18:30 Mon-Fri
	Bosnia Herzegovina	00387-33773163	09:00-17:00 Mon-Fri
	Bulgaria	00359-70014411	09:30-18:30 Mon-Fri
		00359-29889170	09:30-18:00 Mon-Fri
	Croatia	00385-16401111	09:00-17:00 Mon-Fri
	Montenegro	00382-20608251	09:00-17:00 Mon-Fri
	Serbia	00381-112070677	09:00-17:00 Mon-Fri
Slovenia	00368-59045400	08:00-16:00 Mon-Fri	
	00368-59045401		
Baltic Countries	Estonia	00372-6671796	09:00-18:00 Mon-Fri
	Latvia	00371-67408838	09:00-18:00 Mon-Fri
	Lithuania-Kaunas	00370-37329000	09:00-18:00 Mon-Fri
	Lithuania-Vilnius	00370-522101160	09:00-18:00 Mon-Fri

NOTES:

- For more information, visit the ASUS support site at: <http://support.asus.com>
- UK support email: network_support@asus.com

Manufacturer:	ASUSTeK Computer Inc.	
	Tel:	+886-2-2894-3447
	Address:	4F, No. 150, LI-TE RD., PEITOU, TAIPEI 112, TAIWAN
Authorised representative in Europe:	ASUS Computer GmbH	
	Address:	HARKORT STR. 21-23, 40880 RATINGEN, GERMANY

EAC